

# MP5S/MP5Y/MP5W Series

## High Performance, Digital Pulse Meter

### ■ Features

- Total 16 types of operation mode  
Frequency/Revolutions/Speed, Passing speed, Cycle, Passing time, Time interval, Time differential, Absolute ratio, Error ratio, Density, Error, Length measurement 1, Length measurement 2, Interval, Accumulation, Addition/Subtraction-individual input, Addition/Subtraction-phase difference input
- Various output models  
Relay triple/quintuple output, NPN/PNP open collector quintuple output, BCD dynamic output, PV transmission output (current output), RS485 communication output (Modbus RTU)
- Various functions  
Selectable NPN solid state/contact input, PNP solid state/contact input, prescale, delay monitoring, hysteresis, auto-zero time setting, lock setting, data bank function (MP5W series)
- Max. display range: -19999 to 99999
- Various display units  
rpm, rps, Hz, kHz, sec, min, m, mm, mm/s, m/s, m/min, m/h, l/s, l/min, l/h, %, counts, etc.



MP5S



MP5Y



MP5W

**⚠ Please read "Safety Considerations" in the instruction manual before using.**



### ■ Ordering Information

**MP 5 Y - 4 N**

		Main output (comparative value output)		Sub output (display value output)	
Output	S	N	Indicator	—	
		N	Indicator	—	
Y	1	NPN open collector quintuple output	—		
	2	PNP open collector quintuple output	—		
	3	Indicator	BCD dynamic output		
	4	Indicator	PV transmission output (current output)		
	5	Indicator	RS485 communication output		
	6	Relay triple output (H, GO, L)	—		
W	N	Indicator	—		
	A	Relay quintuple output (HH, H, GO, L, LL)	—		
	1	Relay triple output (H, GO, L)	—		
	2	NPN open collector quintuple output	BCD dynamic output		
	4	NPN open collector quintuple output	PV transmission output (current output)		
	5	PNP open collector quintuple output	PV transmission output (current output)		
	8	NPN open collector quintuple output	RS485 communication output		
	9	PNP open collector quintuple output	RS485 communication output		
	Power supply	2	24VAC 50/60Hz, 24-48VDC		
4		100-240VAC 50/60Hz			
Size	S	DIN W48×H48mm			
	Y	DIN W72×H36mm			
	W	DIN W96×H48mm			
Digits	5	99999 (5-digit)			
Item	MP	Pulse meter			

## Specifications

Series		MP5S	MP5Y	MP5W
Display method		7-segment LED (zero blanking method)		
Character size		W4×H8mm	W7×H14mm	
Display range		-19999 to 99999		
Power supply	AC voltage	100-240VAC~ 50/60Hz		
	AC/DC voltage	24VAC~ 50/60Hz, 24-48VDC=		
Power consumption	AC voltage	Max. 7.5VA (100-240VAC~ 50/60Hz)	Max. 9VA (100-240VAC~ 50/60Hz)	Max. 15VA (100-240VAC~ 50/60Hz)
	AC/DC voltage	Max. 6VA (24VAC~ 50/60Hz), max. 4.5W (24-48VDC=)	Max. 7VA (24VAC~ 50/60Hz), max. 6.2W (24-48VDC=)	Max. 11VA (24VAC~ 50/60Hz), max. 7W (24-48VDC=)
Permissible voltage range		90 to 110% of rated voltage		
External power supply		Max. 12VDC= ±10% 80mA		
Sub power supply		—		Max. 24VDC= 30mA
Input frequency		·Solid state input 1: max. 50kHz (pulse width: min. 10μs) ·Solid state input 2: max. 5kHz (pulse width: min. 100μs) ※ For F7, F8, F9, F10 operation mode, max. 1kHz (pulse width: min. 500μs) ·Contact input: max. 45Hz (pulse width: min. 11ms)		
Input method		[Voltage input] High: 4.5-24VDC=, Low: 0-1VDC, Input impedance: 3.9kΩ [No-voltage input] Short-circuit impedance: max. 80Ω, Residual voltage: max. 1VDC, Open-circuit impedance: min. 100kΩ		
Measurement range		·Operation mode F1, F2, F7, F8, F9, F10 : 0.0005Hz to 50kHz ·Operation mode F3, F4, F5, F6 : 0.01 to max. of each time range ·Operation mode F11, F12, F13, F16 : 0 to 99999 ·Operation mode F14, F15 : -19999 to 99999		
Measurement accuracy (23°C±5°C)		·Operation mode F1, F2, F7, F8, F9, F10 : F.S.±0.05%rdg±1-digit ·Operation mode F3, F4, F5, F6 : F.S.±0.01%rdg±1-digit		
Display cycle		OFF (for F2, F16 operation mode), 0.05, 0.5, 1, 2, 4, 8 sec (same as update output cycle)		
Operation mode		Frequency/Revolutions/Speed (F1), Passing speed (F2), Cycle (F3), Passing time (F4), Time interval (F5), Time differential (F6), Absolute ratio (F7), Error ratio (F8), Density (F9), Error (F10), Length measurement 1 (F11), Interval (F12), Accumulation (F13), Addition/Subtraction-individual input (F14), Addition/Subtraction-phase difference input (F15), Length measurement 2 (F16)		
Prescale function		Direct input method (0.0001×10 <sup>-9</sup> to 9.9999×10 <sup>9</sup> )		
Hysteresis		0 to 9999 <sup>※1</sup>		
Output	Main	Relay triple	250VAC~ 3A, 30VDC= 3A resistive load	
		Relay quintuple	—	250VAC~ 3A, 30VDC= 3A resistive load
		NPN/PNP open collector quintuple	—	Max. 30VDC= 30mA
	Sub	BCD dynamic	Max. 30VDC= 30mA	
		PV transmission	DC4-20mA/DC0-20mA max. load 500Ω	
		Communication	RS485 communication output (Modbus RTU method)	
Memory retention		Non-volatile memory (number of inputs: 100,000 operations)		
Insulation resistance		Over 100MΩ (at 500VDC megger)		
Dielectric strength		2,000VAC 60Hz for 1 min		
Noise immunity		±2kV the square wave noise (pulse width: 1μs) by the noise simulator		
Vibration	Mechanical	0.75mm amplitude at frequency of 10 to 55Hz in each X, Y, Z direction for 1 hour		
	Malfunction	0.5mm amplitude at frequency of 10 to 55Hz in each X, Y, Z direction for 10 min		
Shock	Mechanical	300m/s <sup>2</sup> (approx. 30G) in each X, Y, Z direction for 3 times		
	Malfunction	100m/s <sup>2</sup> (approx. 30G) in each X, Y, Z direction for 3 times		
Relay life cycle	Mechanical	—	Min. 10,000,000 operations	
	Electrical	—	Min. 100,000 operations (250VAC 3A resistive load)	
Environment	Ambient temp.	-10 to 50°C, storage: -20 to 60°C		
	Ambient humi.	35 to 85%RH, storage: 35 to 85%RH		
Approval				
Weight <sup>※2</sup>		Approx. 191g (approx. 132g)	Approx. 230g (approx. 140g)	Approx. 334g (approx. 210g)

※1: Setting range will vary depending on the decimal point.

※2: The weight includes packaging. The weight in parenthesis is for unit only.

※Environment resistance is rated at no freezing or condensation.

SENSORS

CONTROLLERS

MOTION DEVICES

SOFTWARE

(J) Temperature Controllers

(K) SSRs

(L) Power Controllers

(M) Counters

(N) Timers

(O) Digital Panel Meters

(P) Indicators

(Q) Converters

(R) Digital Display Units

(S) Sensor Controllers

(T) Switching Mode Power Supplies

(U) Recorders

(V) HMIs

(W) Panel PC

(X) Field Network Devices

# MP5S/MP5Y/MP5W Series

## ■ Connections

※Terminal connections differ by power supply and output type of each series and model.

### ○ MP5S Series

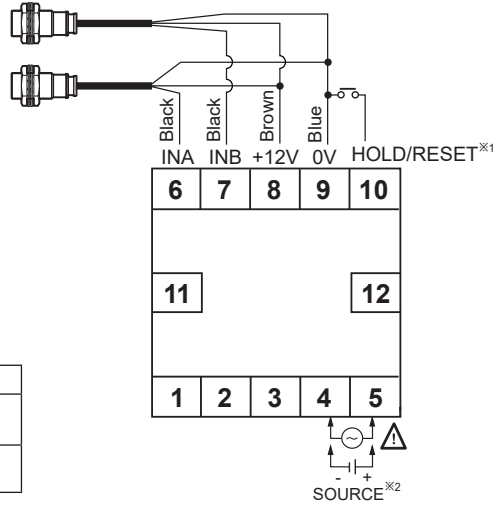

※1: Operation mode F1 to F12  
: display value HOLD  
Operation mode F13 to F16  
: display value RESET

※2:

Model	Source
MP5S-2N	24-48VDC 24VAC 50/60Hz
MP5S-4N	100-240VAC 50/60Hz

### ○ MP5Y Series

#### ● Power/Input Terminal (Common)

※MP5Y-□N (indicator) only has 'Power/Input terminals'.

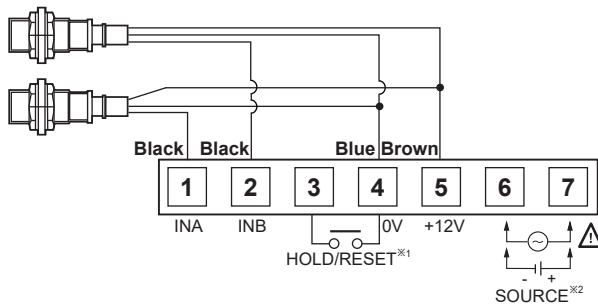

※1: Operation mode F1 to F12  
: display value HOLD  
Operation mode F13 to F16  
: display value RESET

※2:

Model	Source
MP5Y-2□	24-48VDC 24VAC 50/60Hz
MP5Y-4□	100-240VAC 50/60Hz

#### ● Output Connector (MP5Y-□1 to 5)

※Hirose connector: HIF3BA-10PA-2.54DS

※Hirose connector socket: HIF3BA-10D-2.54R (sold separately)

※Hirose connector socket is not included. Contact a hirose connector dealer regarding sockets and cables.

#### ● MP5Y-□1 (NPN open collector output)

**MAIN OUT (NPN OPEN COLLECTOR)**  
30VDC 30mA

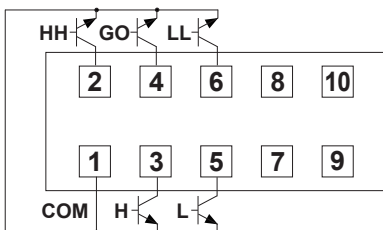

#### ● MP5Y-□2 (PNP open collector output)

**MAIN OUT (PNP OPEN COLLECTOR)**  
30VDC 30mA

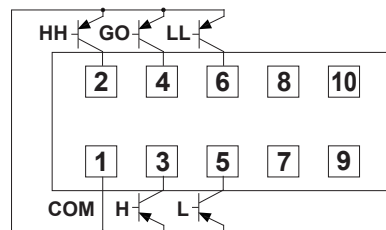

● **MP5Y-□3 (BCD dynamic output)**

**BCD OUT (NPN OPEN COLLECTOR)**  
30VDC 30mA

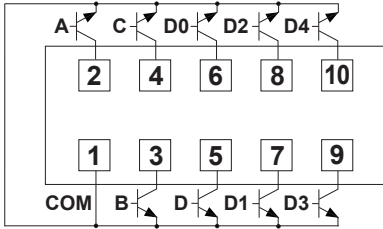

※Autonics display unit (DS/DA Series) is recommended for stable minus (-) sign display.

● **MP5Y-□4 (PV transmission output)**

**DC4-20mA/DC0-20mA**  
Load 500Ω Max.

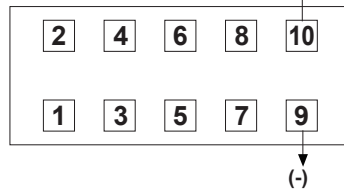

● **MP5Y-□5 (RS485 communication output)**

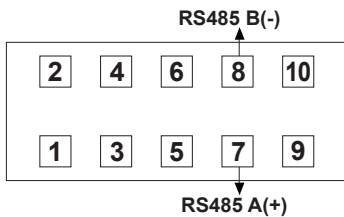

● **Output Terminal (MP5Y-□6)**

● **MP5Y-□6 (Relay triple output)**

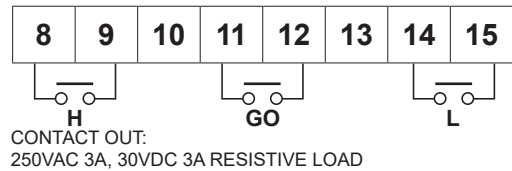

◎ **MP5W Series**

● **Power/Input Terminal (Common)**

※MP5W-□N (indicator) only has 'Power/Input terminals'.

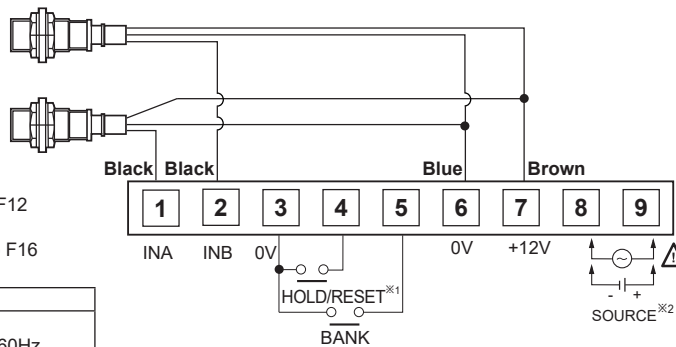

※1: Operation mode F1 to F12 : display value HOLD  
Operation mode F13 to F16 : display value RESET

Model	Source
MP5W-2□	24-48VDC 24VAC 50/60Hz
MP5W-4□	100-240VAC 50/60Hz

● **Output Terminal (MP5W-□A/1)**

● **MP5W-□A (Relay quintuple output)**

**CONTACT OUT:**  
250VAC 3A, 30VDC 3A RESISTIVE LOAD

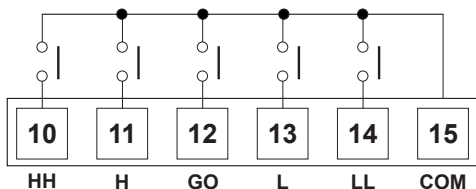

● **MP5W-□1 (Relay triple output)**

**CONTACT OUT:**  
250VAC 3A, 30VDC 3A RESISTIVE LOAD

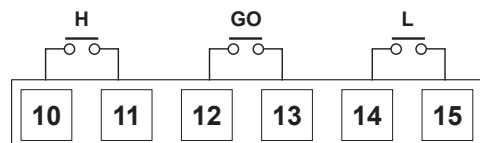

SENSORS
CONTROLLERS
MOTION DEVICES
SOFTWARE

(J) Temperature Controllers
(K) SSRs
(L) Power Controllers
(M) Counters
(N) Timers
(O) Digital Panel Meters
(P) Indicators
(Q) Converters
(R) Digital Display Units
(S) Sensor Controllers
(T) Switching Mode Power Supplies
(U) Recorders
(V) HMIs
(W) Panel PC
(X) Field Network Devices

# MP5S/MP5Y/MP5W Series

## • Output Connector (MP5W-□2/4/5/8/9)

※Hirose connector: HIF3BA-20PA-2.54DS

※Hirose connector socket: HIF3BA-20D-2.54R (sold separately)

※Hirose connector socket is not included. Contact a hirose connector dealer regarding sockets and cables.

※1: Sub power supply

※2: POL signal turns ON when the display value is a minus (-) value.

### • MP5W-□2 (NPN open collector+BCD dynamic output)

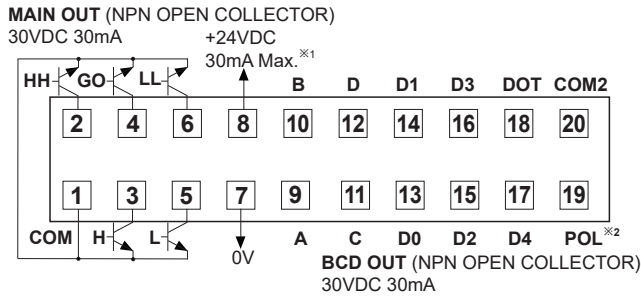

※Autonics display unit (DS/DA Series) is recommended for stable minus (-) sign display.

### • MP5W-□4 (NPN open collector+PV transmission output)

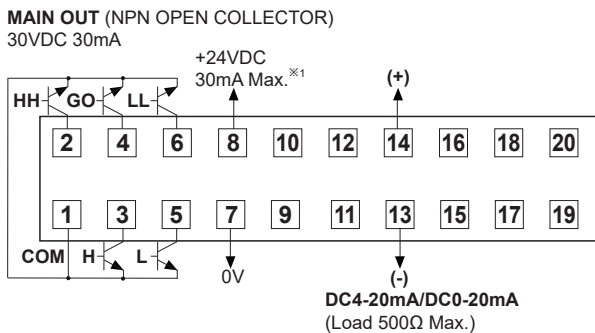

### • MP5W-□5 (PNP open collector+PV transmission output)

MAIN OUT (PNP OPEN COLLECTOR)  
30VDC 30mA

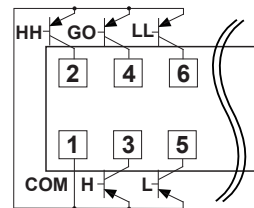

### • MP5W-□8 (NPN open collector+RS485 comm. output)

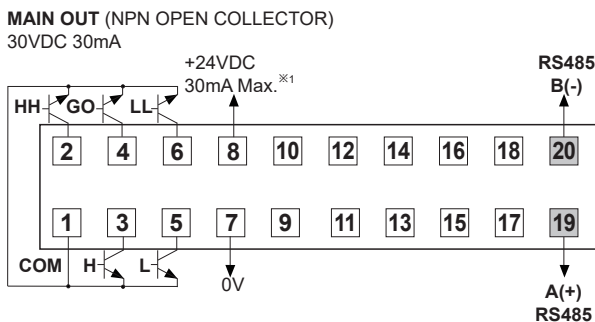

### • MP5W-□9 (PNP open collector+RS485 comm. output)

MAIN OUT (PNP OPEN COLLECTOR)  
30VDC 30mA

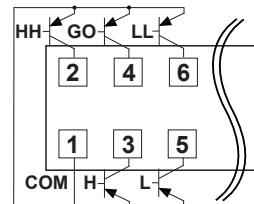

## ■ Dimensions

※Side dimensions of MP5Y/W differ by output type.

(unit: mm)

### ◎ MP5S Series

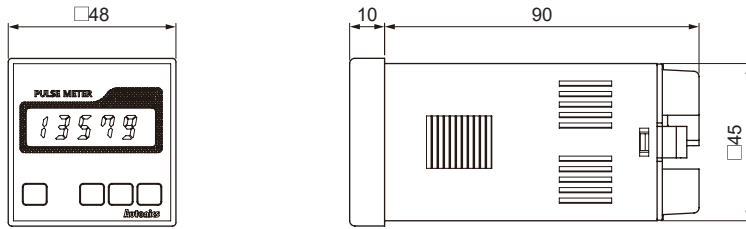

### ◎ MP5Y Series

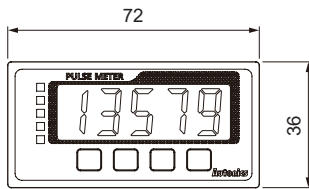

#### ● MP5Y-□N

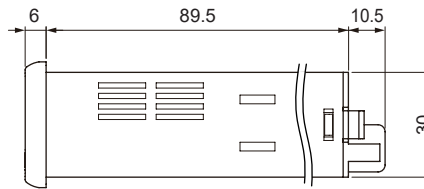

#### ● MP5Y

□1/2/3/4/5

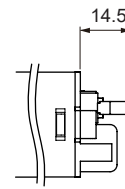

#### ● MP5Y-□6

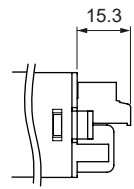

### ◎ MP5W Series

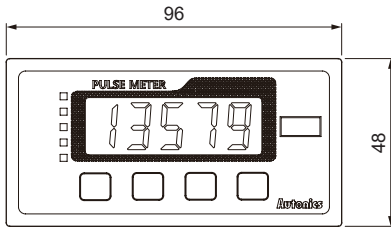

#### ● MP5W-□N

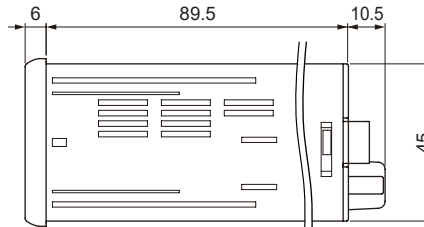

#### ● MP5W-□A/1

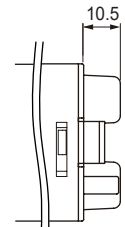

#### ● MP5W

□2/4/5/8/9

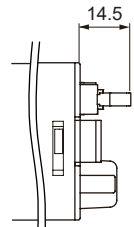

### ● Panel cut-out

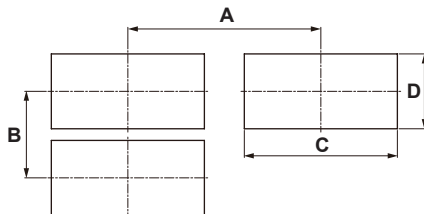

Size		(unit: mm)			
Series	A	B	C	D	
MP5S	Min. 55	Min. 62	45.5 <sup>+0.5</sup>	45.5 <sup>+0.5</sup>	
MP5Y	Min. 91	Min. 40	68 <sup>+0.7</sup>	31.5 <sup>+0.6</sup>	
MP5W	Min. 116	Min. 52	92 <sup>+0.8</sup>	45 <sup>+0.6</sup>	

### ● Bracket

#### ● For MP5S

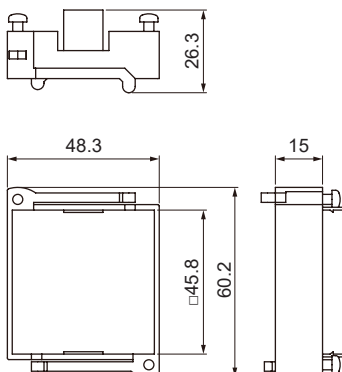

#### ● For MP5Y/W

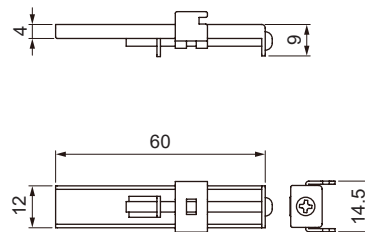

SENSORS
CONTROLLERS
MOTION DEVICES
SOFTWARE
(J) Temperature Controllers
(K) SSRs
(L) Power Controllers
(M) Counters
(N) Timers
(O) Digital Panel Meters
(P) Indicators
(Q) Converters
(R) Digital Display Units
(S) Sensor Controllers
(T) Switching Mode Power Supplies
(U) Recorders
(V) HMIs
(W) Panel PC
(X) Field Network Devices

# MP5S/MP5Y/MP5W Series

## Unit Description

### MP5 Series

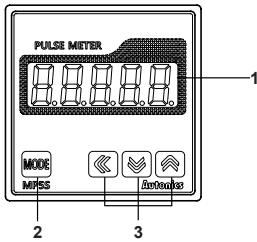

### MP5S Series

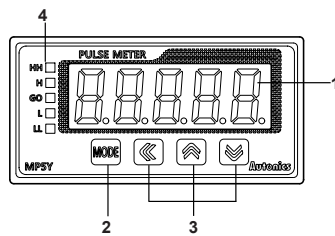

### MP5S Series

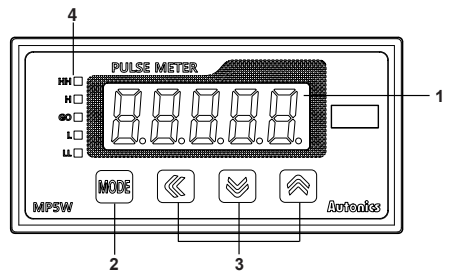

#### 1: Display component

Displays current value in RUN mode.

Alternately displays setting parameters and corresponding value in SETTING mode.

#### 2: MODE key

In RUN mode, press the key once to check max./min. value.

In RUN mode, hold the key for over 2 sec to enter parameter groups.

#### 3: Arrow keys

Select parameter groups, and select or setting values in the corresponding parameters.

#### 4: Output status indicator

## Sold Separately

### Communication converter

#### SCM-WF48

(Wi-Fi to RS485-USB wireless communication converter)



#### SCM-US48I

(USB to RS485 converter)



#### SCM-38I

(RS232C to RS485 converter)



### Display Units (DS/DA-T Series)

#### DS/DA-T Series

(RS485 communication input type display unit) CE



DS16-□T



DS22/DA22-□T



DS40/DA40-□T



DS60/DA60-□T

※Connect RS485 communication input type display unit (DS/DA-T Series) and RS485 communication output model of MP5Y/MP5W Series, the display unit displays present value of the device without PC/PLC.

## Input Specifications

### 1. Input signal

Standard duty ratio of input signal is 1:1.

#### (1) Solid state input 1

Input frequency: Max. 50kHz (ON/OFF pulse width: min. 10μs of each)

#### (2) Solid state input 2

Input frequency: Max. 5kHz (ON/OFF pulse width: min. 100μs of each)

※For F7, F8, F9, F10 operation mode, max. 1kHz (ON/OFF pulse width: min. 500μs of each)

#### (3) Contact input

① Input frequency: Max. 45Hz (when each ON/OFF pulse width is over 11ms)

② Contact specifications: 12VDC, stable switching of load current as small as 5mA

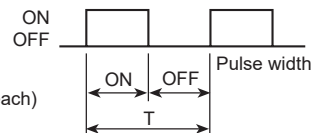

※T: single cycle of input signal

### 2. Input type [I n - R, I n - b]

MP5 allows selection between NPN input (solid state/contact) or PNP input (solid state/contact).

#### (1) NPN input type

- ① Contact
- ② NPN voltage output type sensor
- ③ NPN open collector output type sensor

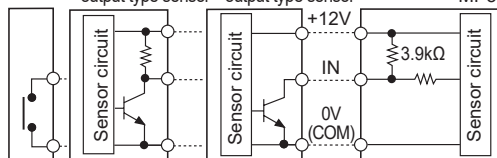

#### (2) PNP input type

- ① Contact
- ② PNP voltage output type sensor
- ③ PNP open collector output type sensor

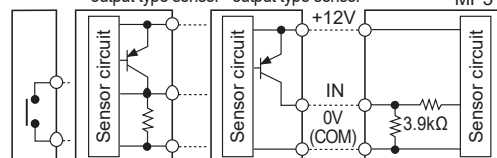

## Output Specifications

### 1. Relay output

- ① Output: Comparative or alarm output (refer to "Output Modes")
- ② Output type: Relay
- ③ Contact capacity: 250VAC 3A resistive load
- ④ Life cycle: [Mechanical] min. 10,000,000 operations (switching frequency 180 operations/min)  
[Electrical] min. 100,000 operations (3A 250VAC, 30VDC resistive load) (switching frequency 20 operations/min)

### 2. Transistor output

- ① Output: Comparative output or alarm output (refer to "Output Modes")
- ② Output type: NPN/PNP open collector
- ③ Rated load voltage: 30VDC
- ④ Max. load current: 30mA

### 3. BCD dynamic output (negative logic)

- ① Output: present value
- ② Output signal: BCD data (A, B, C, D, DOT)  
← A: lowest bit, DOT: highest bit  
Digit data (D0, D1, D2, D3, D4)  
← D0: lowest digit, D4: highest digit
- ③ Output type: NPN open collector
- ④ Rated load voltage: 30VDC
- ⑤ Max. load current: 30mA
- ⑥ Dynamic COM cycle (T) = 40ms

E.g.) To display value = 125.89 by BCD dynamic output

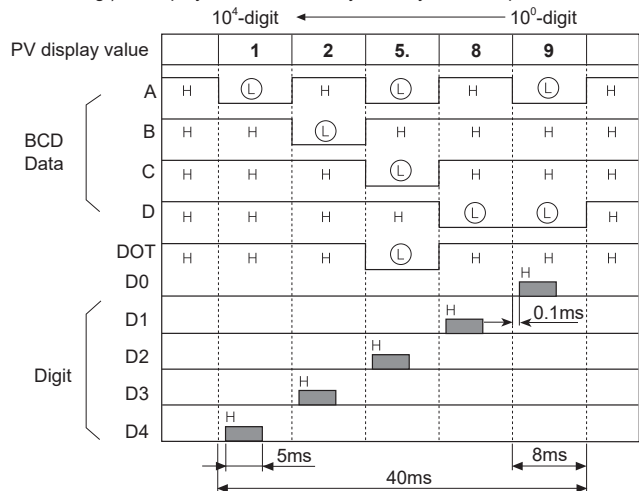

### 4. PV transmission output

- ① Application: transmit measured value
  - ② Function: transmit measured value within setting range of high-limit output [F5-H] to low-limit output [F5-L] after conversion into DC4-20mA or DC0-20mA current.
  - ③ Output range of high/low-limit  
·High-limit [F5-H] range: From min. value to max. value within measurement range  
·Low-limit [F5-L] range: From min. value to max. value within measurement range ( $[F5-H] \geq [F5-L] + 1$ )
- (1) DC4-20mA transmission output
- ① Transmit measured value within setting range of high-limit output [F5-H] to low-limit output [F5-L] after conversion into DC4-20mA current.
  - ② Resistive load: Max. 500Ω
  - ③ Resolution: 8000 divisions
- (2) DC0-20mA transmission output
- ① Transmit measured value within setting range of high-limit output [F5-H] to low-limit output [F5-L] after conversion into DC0-20mA current.
  - ② Resistive load: Max. 500Ω
  - ③ Resolution: 10,000 divisions

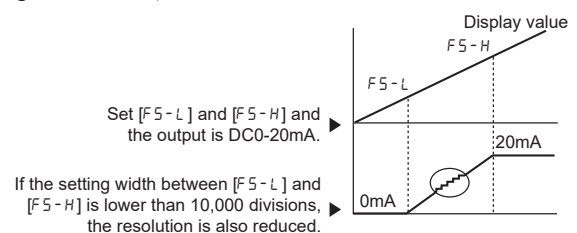
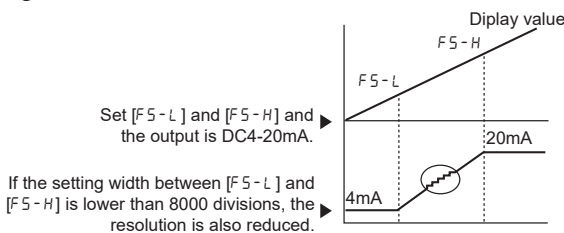

### 5. RS485 communication output

Comm. protocol	Modbus RTU	Communication Speed	2400, 4800, 9600 (default), 19200, 38400 bps
Connection type	RS485	Communication response time	5 to 99ms (default: 20ms)
Application standard	Compliance with EIA RS485	Start Bit	1-bit fixed
Max. connection	31 units (address: 01 to 99)	Data Bit	8-bit fixed
Synchronous method	Asynchronous	Parity Bit	None (default), Even, Odd
Comm. method	Two-wire half duplex	Stop Bit	1, 2-bit (default)
Comm. distance	Max. 800m		

※For more information about RS485 communication output specifications, refer to 'RS485 Communication Output'.

SENSORS

CONTROLLERS

MOTION DEVICES

SOFTWARE

(J) Temperature Controllers

(K) SSRs

(L) Power Controllers

(M) Counters

(N) Timers

(O) Digital Panel Meters

(P) Indicators

(Q) Converters

(R) Digital Display Units

(S) Sensor Controllers

(T) Switching Mode Power Supplies

(U) Recorders

(V) HMIs

(W) Panel PC

(X) Field Network Devices



# MP5S/MP5Y/MP5W Series

## Parameter Groups

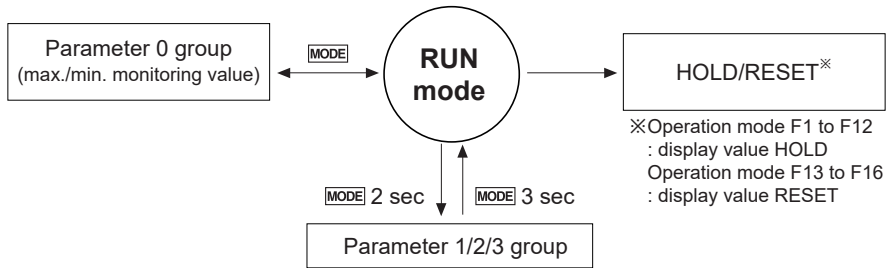

※Operation mode F1 to F12  
: display value HOLD  
Operation mode F13 to F16  
: display value RESET

※Press the , , keys to select or set the desired value.

※Press the **MODE** key once after changing the setting value, to save the setting value and move to the next parameter.

※Hold the **MODE** key for 1.5 sec at any parameters to return to the select parameter group mode.

※Hold the **MODE** key for 3 sec to save the setting value and return to RUN mode after changing the setting value.

※If there is no key input for 60 sec while setting the parameters, the new settings are ignored, and the unit will return to RUN mode with previous settings.

※The dotted line parameters may not appear depending on output specifications or other parameter settings. Please refer to **Operation Mode by Parameter Group**.

※1: Each parameter and corresponding setting value will flash alternately every 0.5 sec.

### Parameter 0 group

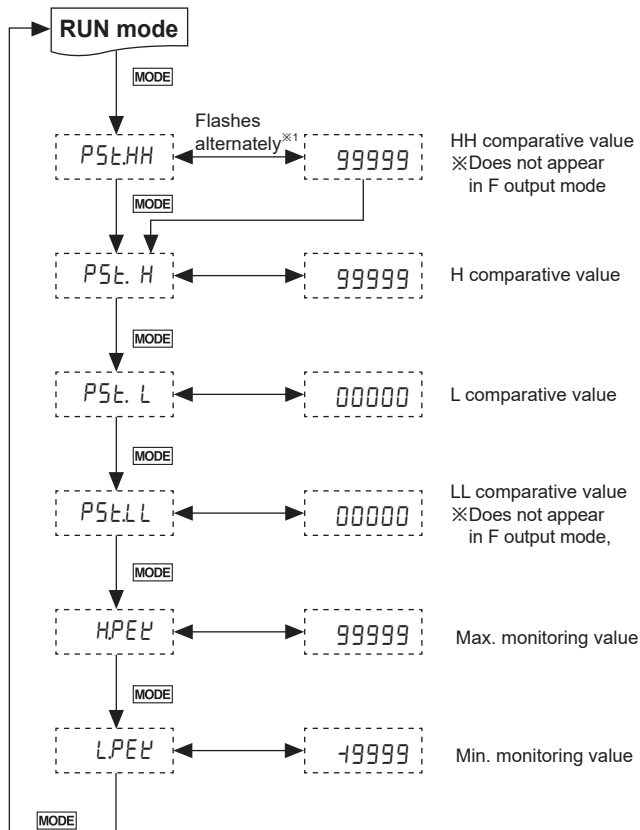

※The parameters are identical to [P5t.HH], [P5t.H], [P5t.L], [P5t.LL] of parameter 2 group and the setting values will be linked.  
●Setting range by operation mode

Operation mode	Setting range
F1, F2, F7, F9, F11, F12, F13, F16	0 to 99999
F3, F4, F5, F6	0 to setting time range
F8, F10, F14, F15	-99999 to 99999

(the setting range varies depending on the decimal point setting.)

※Only appears in comparative value setting models.

※Resetting monitoring value  
: Hold the key for over 2 sec (reset current value)

## Parameter 1 group

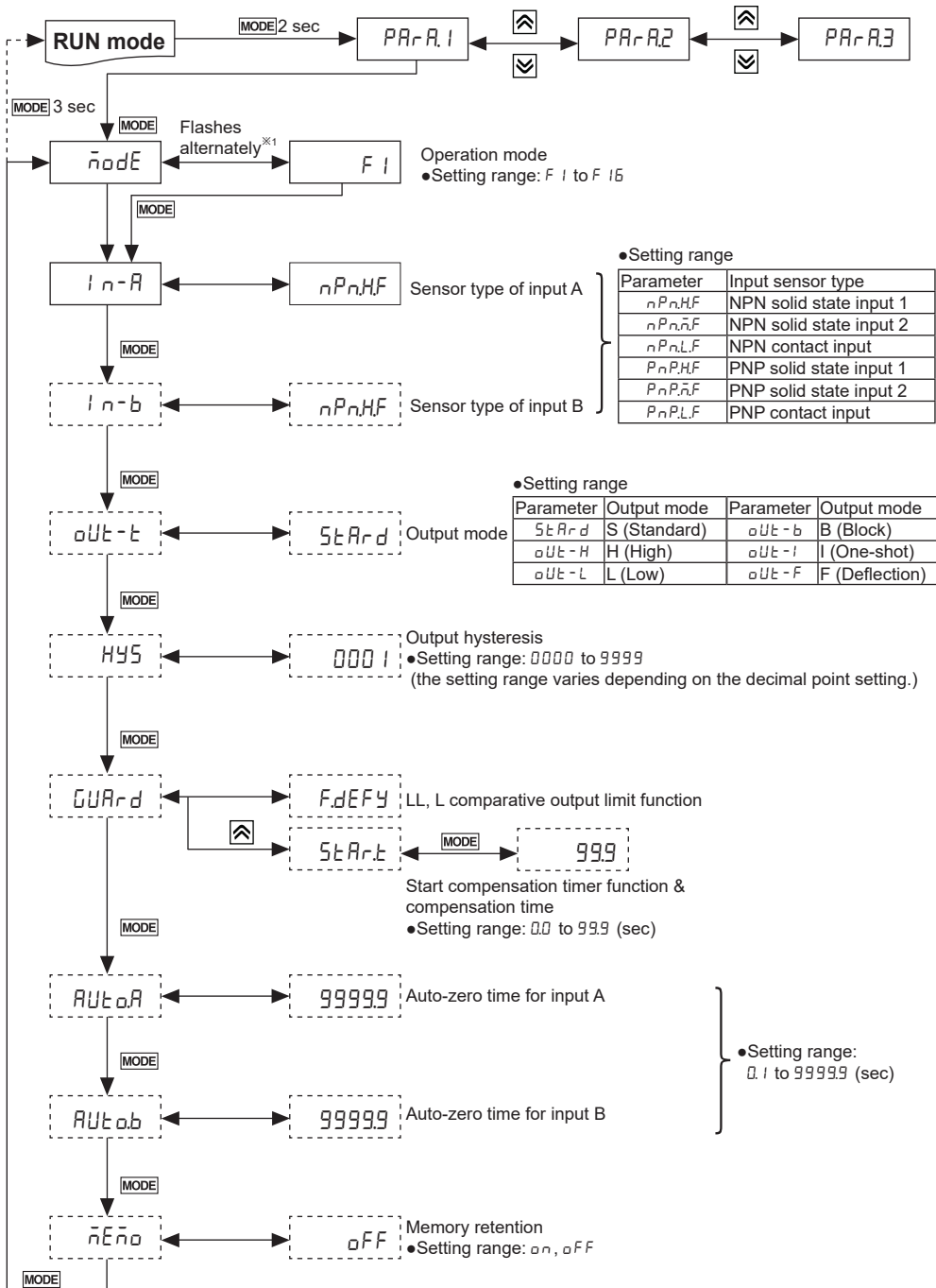

※Does not appear in indicator models.

SENSORS
CONTROLLERS
MOTION DEVICES
SOFTWARE
(J) Temperature Controllers
(K) SSRs
(L) Power Controllers
(M) Counters
(N) Timers
(O) Digital Panel Meters
(P) Indicators
(Q) Converters
(R) Digital Display Units
(S) Sensor Controllers
(T) Switching Mode Power Supplies
(U) Recorders
(V) HMIs
(W) Panel PC
(X) Field Network Devices

# MP5S/MP5Y/MP5W Series

## Parameter 2 group

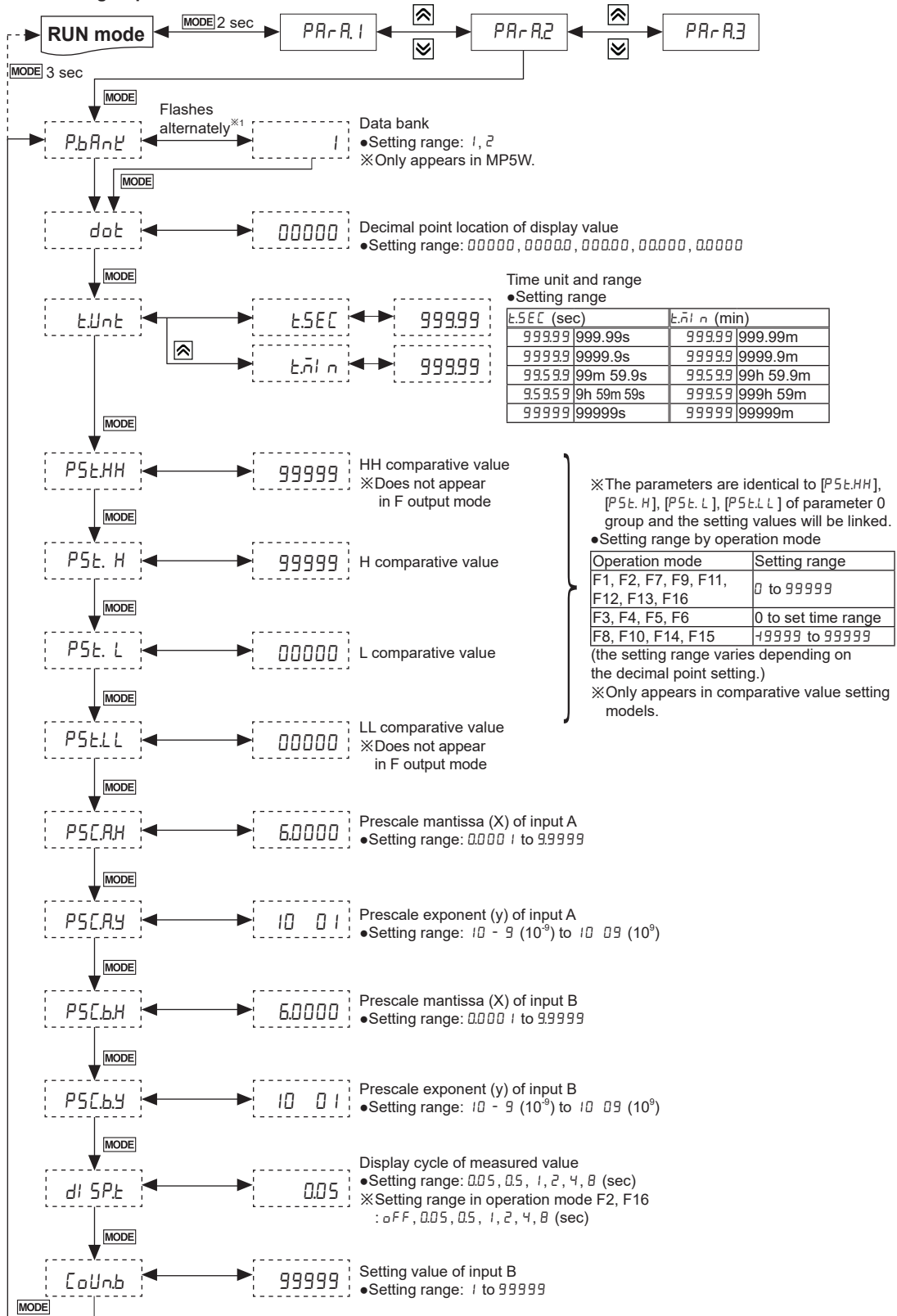

## Parameter 3 group

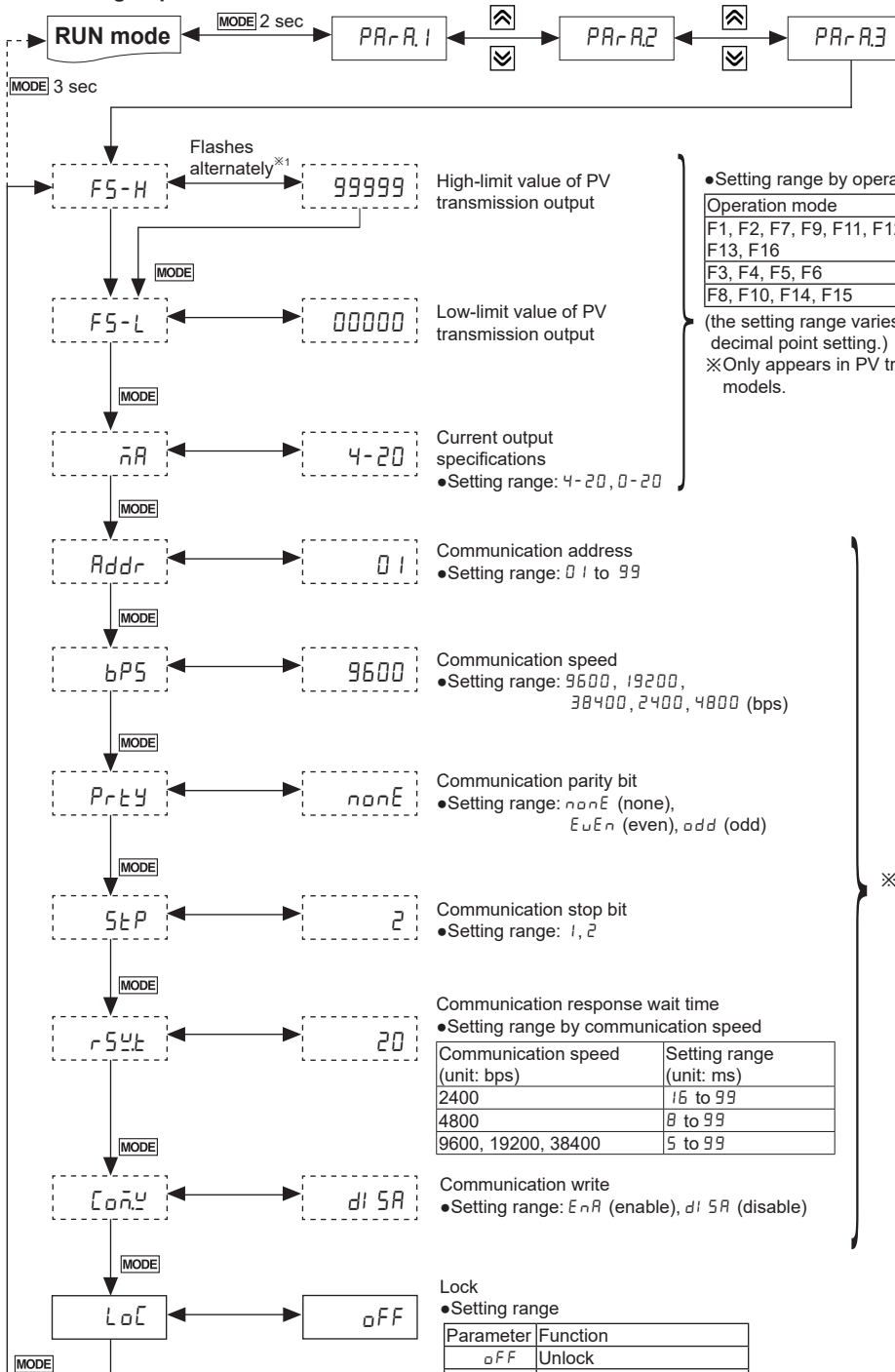

● Setting range by operation mode

Operation mode	Setting range
F1, F2, F7, F9, F11, F12, F13, F16	0 to 99999
F3, F4, F5, F6	0 to set time range
F8, F10, F14, F15	+9999 to 99999

(the setting range varies depending on the decimal point setting.)  
 ※ Only appears in PV transmission output models.

● Setting range: 4-20, 0-20  
 ● Setting range: 01 to 99  
 ● Setting range: 9600, 19200, 38400, 2400, 4800 (bps)  
 ● Setting range: none, Even (even), odd (odd)  
 ● Setting range: 1, 2  
 ● Setting range by communication speed

Communication speed (unit: bps)	Setting range (unit: ms)
2400	15 to 99
4800	8 to 99
9600, 19200, 38400	5 to 99

● Setting range: EnA (enable), d1SA (disable)

Lock

● Setting range

Parameter	Function
oFF	Unlock
LoC.0	Lock all
LoC.1	Parameter 1/2/3 lock
LoC.2	Parameter 2/3 lock
LoC.3	Parameter 3 lock

※ Only appears in RS485 comm. output models.

SENSORS
CONTROLLERS
MOTION DEVICES
SOFTWARE
(J) Temperature Controllers
(K) SSRs
(L) Power Controllers
(M) Counters
(N) Timers
(O) Digital Panel Meters
(P) Indicators
(Q) Converters
(R) Digital Display Units
(S) Sensor Controllers
(T) Switching Mode Power Supplies
(U) Recorders
(V) HMIs
(W) Panel PC
(X) Field Network Devices

# MP5S/MP5Y/MP5W Series

## ■ Operation Mode by Parameter Groups

(●: parameter display, X: no parameter display)

Operation mode		F1	F2	F3	F4	F5	F6	F7	F8	F9	F10	F11	F12	F13	F14	F15	F16
0 group	P5t.HH※1	Appears in all operation modes (F1 to F16).															
	P5t.H※2																
	P5t.L※2																
	P5t.LL※1																
HPEL	●	●	●	●	●	●	●	●	●	●	●	●	●	X	●	●	X
LPEL	●	●	●	●	●	●	●	●	●	●	●	●	●	X	●	●	X
1 group	nodE	Appears in all operation mode (F1 to F16).															
	in-R																
	in-b	X	●	X	X	X	●	●	●	●	●	●	●	●	●	X※3	●
	out-t※2	●	●	●	●	●	●	●	●	●	●	●	●	X	●	●	●
	HYS※2	●	X	X	X	X	X	●	●	●	●	X	X	X	X	X	X
	curd※2	●	●	●	●	●	●	●	●	●	●	●	●	X	X	X	X
	out-aR	●	X	X	●	X	X	●	●	●	●	X	X	X	X	X	X
	out-ab	X	X	X	X	X	X	●	●	●	●	X	X	X	X	X	X
enno	X	X	X	X	X	X	X	X	X	X	X	X	X	●	●	●	●
2 group	PbRnE	※Only appears in MP5W. Appears in all operation modes (F1 to F16).															
	dot	●	●	X	X	X	X	●	●	●	●	●	●	●	●	●	●
	tUnb	X	X	●	●	●	●	X	X	X	X	X	X	X	X	X	X
	P5t.HH※1	Appears in all operation modes (F1 to F16).															
	P5t.H※2																
	P5t.LL※2																
	P5t.L※1																
	P5CRH	●	●	X	●	X	X	●	●	●	●	●	●	●	●	●	●
	P5CRY	●	●	X	●	X	X	●	●	●	●	●	●	●	●	●	●
	P5CbH	X	X	X	X	X	X	●	●	●	●	X	X	X	X	X	X
	P5CbY	X	X	X	X	X	X	●	●	●	●	X	X	X	X	X	X
dSPt	●	■※5	X	X	X	X	●	●	●	●	X	X	X	X	X	■	
CoUnb	X	X	X	X	X	X	X	X	X	X	X	X	X	X	X	X	
3 group	F5-H	※Only appears in PV transmission output models. Appears in operation modes (F1 to F16).															
	F5-L																
	nR																
	Addr	※Only appears in RS485 comm. output models. Appears in all operation modes (F1 to F16).															
	bPS																
	PrtY																
	StP																
	rEUL																
	CoUL																
LoC	●	●	●	●	●	●	●	●	●	●	●	●	●	●	●	●	

※1: Only appears in only for quintuple output models.

※2: Only appears in triple, quintuple output models.

※3: The settings for *in-b* and *in-R* are applied.

※4: (●) F output mode [out-F] cannot be set.

※5: (■) setting range: OFF, 0.05, 0.5, 1, 2, 4, 8

### ● Monitoring delay function by output mode

Output mode	S mode	H mode	L mode	B mode	I mode	F mode
Parameter	StRRd	out-h	out-L	out-b	out-I	out-F
Comparative output limit	●	X	X	●	X	●
Start compensation timer	●	●	●	●	●	●

## ■ Operation Modes [r o d E]

- Select operation mode from operation mode[r o d E] of parameter 1 group..
- MP5 has 16 operation modes.

### ○ F1 Mode: Frequency/Revolutions/Speed

Measures the frequency of input A and displays the calculated frequency, revolutions, and speed.

1) Frequency (Hz)	= $f \times \alpha$	( $\alpha = 1$ [sec])
2) Revolutions (rpm)	= $f \times \alpha$	( $\alpha = 60$ [sec])
3) Speed (m/min)	= $f \times \alpha$	( $\alpha = 60L$ [sec])

※L: travel distance of conveyor belt of 1 pulse cycle[m]  
 $\alpha$ : prescale value

For multiple objects,  $\alpha = \frac{60L}{N}$

- Display value and display unit

Display value	Display unit	$\alpha$ (prescale value)
Frequency	Hz	1
	kHz	0.001
Revolutions	rps	1
	rpm (default)	60
Speed	mm/sec	1,000L
	cm/sec	100L
	m/sec	1L
	m/min	60L
	km/hour	3.6L

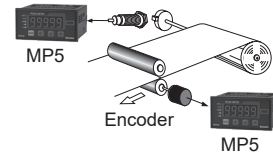

- Timing chart

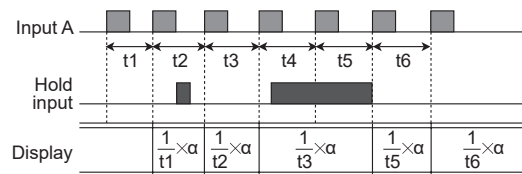

### ○ F2 Mode: Passing Speed

Displays the passing speed between input A ON and input B ON.

Passing speed (V) =  $f \times \alpha$  ( $\alpha = L$  [m])

※f: reciprocal of time [sec] between input A (sensor) ON and input B (sensor) ON.

L: distance between input A (sensor) and input B (sensor) [m]  
 $\alpha$ : prescale value

- Display value and display unit

Display value	Display unit	$\alpha$ (prescale value)
Passing speed	mm/sec	1,000L
	cm/sec	100L
	m/sec (default)	1L
	m/min	60L
	km/hour	3.6L

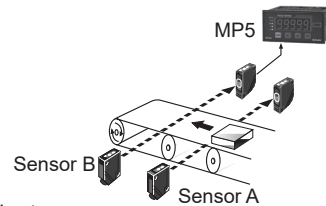

- Timing chart

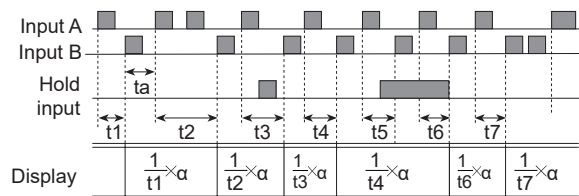

※ta: Return time (over 20ms)

### ○ F3 Mode: Cycle

Displays the measured time from Input A ON to the next ON.

Cycle (T) = t

※t: measurement time [sec]

- Display value and display unit ([t.u n t] of parameter 2)

Display value	Display unit	
Cycle	Sec	Min
	999.99s (default)	999.99m
	9999.9s	9999.9m
	99m 59.9s	99h 59.9m
	9h 59m 59s	999h 59m
	99999s	99999m

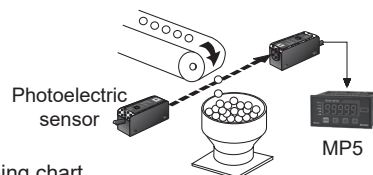

- Timing chart

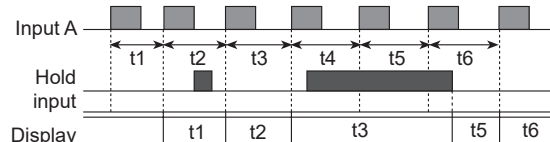

SENSORS

CONTROLLERS

MOTION DEVICES

SOFTWARE

(J) Temperature Controllers

(K) SSRs

(L) Power Controllers

(M) Counters

(N) Timers

(O) Digital Panel Meters

(P) Indicators

(Q) Converters

(R) Digital Display Units

(S) Sensor Controllers

(T) Switching Mode Power Supplies

(U) Recorders

(V) HMIs

(W) Panel PC

(X) Field Network Devices

# MP5S/MP5Y/MP5W Series

## ◎ F4 Mode: Passing Time

Measures the time from Input A ON to the next ON, and displays the passing time of the arbitrary distance.

$$\text{Passing time[sec]} = t \times \alpha$$

$$\left( \alpha = \frac{L[\text{m}]}{\text{Distance advanced in 1 pulse cycle [m]}} \right)$$

※t : measured time[sec], L : arbitrary distance[m]  
α : prescale value

- Display value and display unit ([Unit] of parameter 2)

Display value	Display unit	
Passing time	SEC	MIN
	999.99s (default)	999.99m
	9999.9s	9999.9m
	99m 59.9s	99h 59.9m
	9h 59m 59s	999h 59m
	99999s	99999m

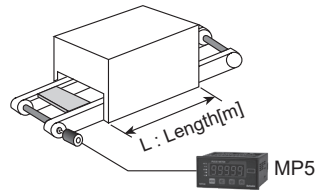

### • Timing chart

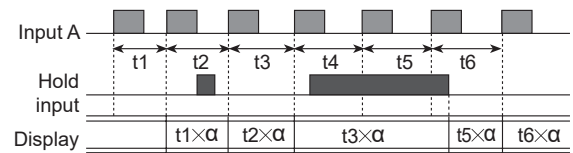

## ◎ F5 Mode: Time Interval

Displays measured time of Input A ON

$$\text{Time interval (T)} = t$$

※t : measured time of input A ON [sec]

- Display value and display unit ([Unit] of parameter 2)

Display value	Display unit	
Time interval	SEC	MIN
	999.99s (default)	999.99m
	9999.9s	9999.9m
	99m 59.9s	99h 59.9m
	9h 59m 59s	999h 59m
	99999s	99999m

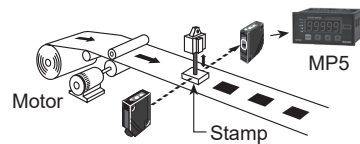

### • Timing chart

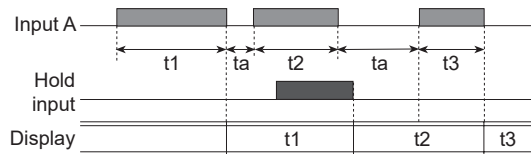

※ta: Return time (over 20ms)

## ◎ F6 Mode: Time Differential

Displays measured time from Input A ON to Input B ON.

$$\text{Time differential (T)} = t (ta \text{ to } tb)$$

※t (ta to tb): measured time from input A ON to input B ON [sec]

- Display value and display unit ([Unit] of parameter 2)

Display value	Display unit	
Time difference	SEC	MIN
	999.99s (default)	999.99m
	9999.9s	9999.9m
	99m 59.9s	99h 59.9m
	9h 59m 59s	999h 59m
	99999s	99999m

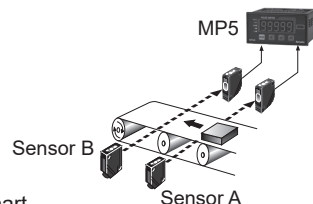

### • Timing chart

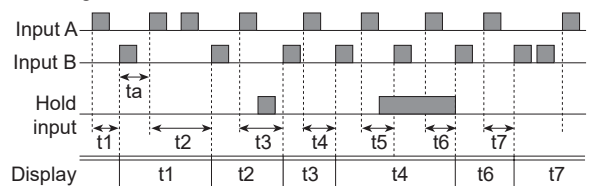

※ta: Return time (over 20ms)

## ◎ F7 Mode: Absolute Ratio

Measures and displays relative speed, amount, speed, etc. of input B against input A in percentage (%).

$$\text{Absolute ratio} = \frac{\text{Input B}}{\text{Input A}} \times 100\%$$

$$\text{Absolute ratio} = \frac{\text{Frequency of input B[Hz]} \times \text{Ba}}{\text{Frequency of input A[Hz]} \times \text{Aa}} \times 100\%$$

※Aa: Prescale value of input A, Ba: Prescale value of input B

### • Display value and display unit

Display value	Display unit
Absolute ratio	%

※Hold: When the hold signal turns ON, the display value is maintained until the display cycle turns to hold OFF.

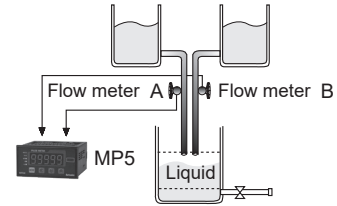

### • Timing chart

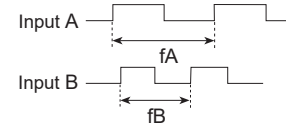

$$\text{Display} = \frac{\text{Frequency of input B[Hz]} \times \text{Ba}}{\text{Frequency of input A[Hz]} \times \text{Aa}} \times 100\%$$

## ◎ F8 Mode: Error Ratio

Measures and displays the relative rate of input B against the reference value of input A in percentage (%).

$$\text{Error ratio} = \frac{\text{Input B} - \text{Input A}}{\text{Input A}} \times 100\%$$

$$\text{Error ratio} = \frac{(\text{Frequency of input B [Hz]} \times \text{Ba}) - (\text{Frequency of input A[Hz]} \times \text{Aa})}{\text{Frequency of input A[Hz]} \times \text{Aa}} \times 100\%$$

※Aa: prescale value of input A, Ba: prescale value of input B

### • Display value and display unit

Display value	Display unit
Error ratio	%

※Hold: When the hold signal turns ON, the display value is maintained until the display cycle turns to hold OFF.

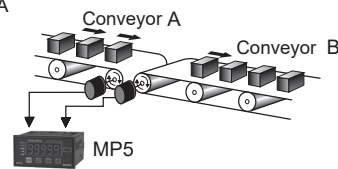

### • Timing chart

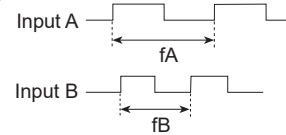

## ◎ F9 Mode: Density

Measures and displays the density ratio (%) of input B against the total sum of input A and input B.

$$\text{Density} = \frac{\text{Input B}}{\text{Input A} + \text{Input B}} \times 100\%$$

$$\text{Density} = \frac{\text{Frequency of Input B[Hz]} \times \text{Ba}}{(\text{Frequency of input A[Hz]} \times \text{Aa}) + (\text{Frequency of input B[Hz]} \times \text{Ba})} \times 100\%$$

※Aa: Prescale value of input A, Ba: Prescale value of input B

### • Display value and display unit

Display value	Display unit
Density	%

※Hold: When the hold signal turns ON, the display value is maintained until the display cycle turns to hold OFF.

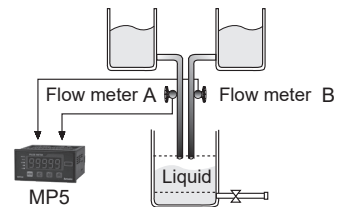

### • Timing chart

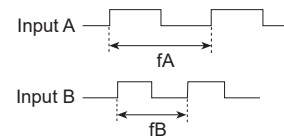

## ◎ F10 Mode: Error

Measures and displays the error of input B against reference value of input A.

$$\text{Error} = \text{Input B} - \text{Input A}$$

$$\text{Error} = (\text{Frequency of input B[Hz]} \times \text{Ba}) - (\text{Frequency of input A[Hz]} \times \text{Aa})$$

※Aa: prescale value of input A, Ba: prescale value of input B

### • Display value and display unit

Display value	Display unit
Error	END User setting

※Hold: When the hold signal turns ON, the display value is maintained until the display cycle turns to hold OFF.

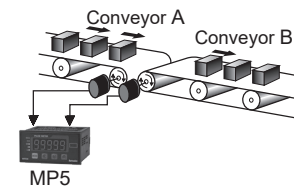

### • Timing chart

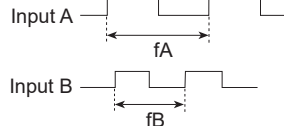

SENSORS

CONTROLLERS

MOTION DEVICES

SOFTWARE

(J) Temperature Controllers

(K) SSRs

(L) Power Controllers

(M) Counters

(N) Timers

(O) Digital Panel Meters

(P) Indicators

(Q) Converters

(R) Digital Display Units

(S) Sensor Controllers

(T) Switching Mode Power Supplies

(U) Recorders

(V) HMIs

(W) Panel PC

(X) Field Network Devices



# MP5S/MP5Y/MP5W Series

## ◎ F11 Mode: Length Measurement 1

Measure and display the number of input A pulses during input B ON.

$$\text{Length measurement} = P \times \alpha$$

※P: Number of input A pulses,  $\alpha$ : Prescale value

### • Display value and display unit

Display value	Display unit
Length measurement	Quantity (default)
	mm
	cm
	m

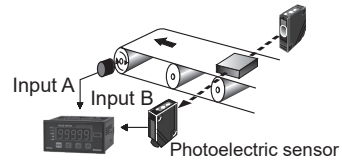

### • Timing chart MP5

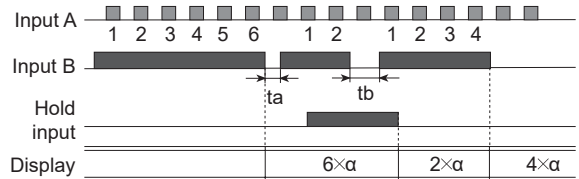

※ta, tb: return time (over 20ms)

## ◎ F12 Mode: Interval

Measures and displays the number of input A pulses from Input B ON to the next ON.

$$\text{Interval} = P \times \alpha$$

※P: Number of input A pulses,  $\alpha$ : Prescale value

### • Display value and display unit

Display value	Display unit
Interval	Quantity (default)
	mm
	cm
	m

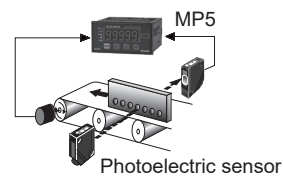

### • Timing chart

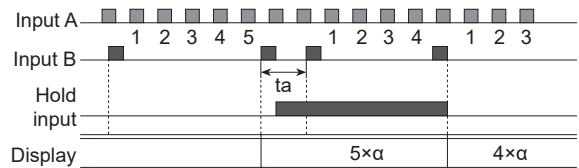

※ta: return time (over 20ms)

## ◎ F13 Mode: Accumulation

Measures and displays the counted value of input A pulses.

$$\text{Accumulation} = P \times \alpha$$

※P: Number of input A pulses,  $\alpha$ : Prescale value

### • Display value and display unit

Display value	Display unit
Accumulation	Quantity[EA]

### • Operation

- ① Counts the number of input A pulses.
- ② Input B is an enable input signal. During ON, the quantity and display value of input A will be held, and during OFF input A will be re-counted.
- ③ When RESET input is ON, the integrated counted value will be reset to "0".

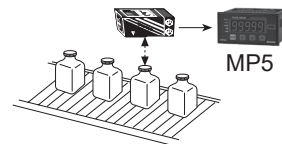

### • Timing chart

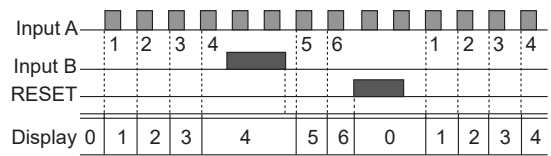

※ $\alpha=1$  display value

## ⊙ F14 Mode: Addition/Subtraction-Individual Input

Displays the counted value from added input A pulses and subtracted input B pulses. When there are two inputs simultaneously, it will not count.

$$\text{Addition/Subtraction} = \text{Input A} \times \alpha - \text{Input B} \times \beta$$

※ $\alpha$ : Prescale value of input A,  $\beta$ : Prescale value of input B

### • Display value and display unit

Display value	Display unit
Addition/ Subtraction (individual input)	Quantity

### • Operation and timing chart

Pulse of input A is added, and pulse of input B is subtracted.

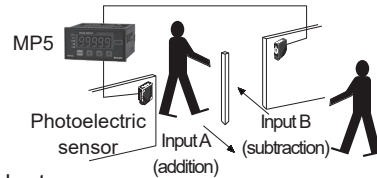

### • Timing chart

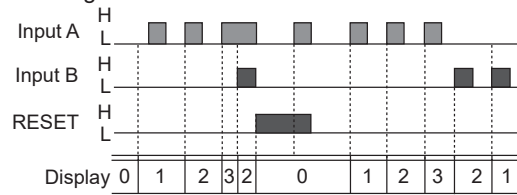

※ $\alpha, \beta=1$  display value

## ⊙ F15 Mode: Addition/Subtraction- Phase difference input

When input A is low, counting is added to the low of input B. When input A is low, counting is subtracted from the high of input B.

Addition/Subtraction (phase difference)  
= Detects position and speed using A and B phases of encoder outputs as input.

### • Display value and display unit

Display value	Display unit
Up/Down counting (phase difference input)	Quantity

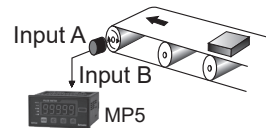

### • Timing chart

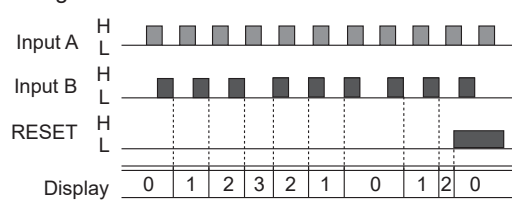

## ⊙ F16 Mode: Length Measurement 2

Measures and displays the number of pulses from input A until the value of input B reaches the set value.

$$\text{Length measurement 2} = P \times \alpha \text{ (until the setting value of Input B)}$$

※P: Number of input A pulses,  $\alpha$ : Prescale value

### • Display value and display unit

Display value	Display unit
Length measurement 2	Quantity[EA]

※If input A and input B are ON during initial power supply, it will not count and only count the number of rising edge.

※Display value is renewed depending on the display cycle [ $d^1$  5P.t.] setting.

### • Timing chart (e.g.) setting value of Input B=4

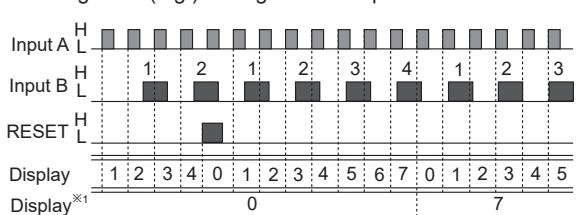

※1: When the display cycle [ $d^1$  5P.t.] setting is OFF, it will maintain the quantity of input A until the value of input B reaches the setting value B [ $C^0$ U.n.b].

SENSORS
CONTROLLERS
MOTION DEVICES
SOFTWARE
(J) Temperature Controllers
(K) SSRs
(L) Power Controllers
(M) Counters
(N) Timers
(O) Digital Panel Meters
(P) Indicators
(Q) Converters
(R) Digital Display Units
(S) Sensor Controllers
(T) Switching Mode Power Supplies
(U) Recorders
(V) HMIs
(W) Panel PC
(X) Field Network Devices

# MP5S/MP5Y/MP5W Series

## Output Modes [出力モード]

- MP5 Series supports 6 output modes. (There is no output mode in indicator models).
- Requirement for setting comparative value: (B output mode)  $LL < L < H < HH$ , (F output mode)  $L < H$ , (other output modes) individual output operation regardless of size or order of set comparative values.

※1: hysteresis

### Standard Output Mode [標準出力モード]

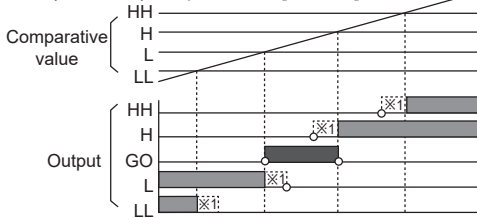

- HH output : Display value  $\geq$  Comparative setting value HH
- H output : Display value  $\geq$  Comparative setting value H
- L output : Display value  $\geq$  Comparative setting value L
- LL output : Display value  $\leq$  Comparative setting value LL
- ※1: GO output ON when there are no HH, H, L, LL outputs

### High Output Mode [高出力モード]

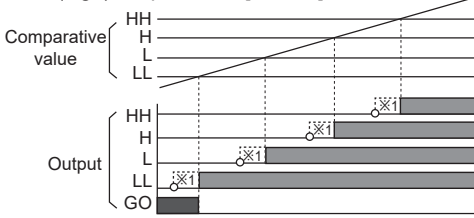

- HH output : Display value  $\geq$  Comparative setting value HH
- H output : Display value  $\geq$  Comparative setting value H
- L output : Display value  $\geq$  Comparative setting value L
- LL output : Display value  $\geq$  Comparative setting value LL
- ※1: GO output ON when there are no HH, H, L, LL outputs

### Low Output Mode [低出力モード]

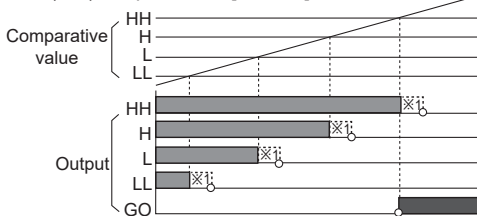

- HH output : Display value  $\leq$  Comparative setting value HH
- H output : Display value  $\leq$  Comparative setting value H
- L output : Display value  $\leq$  Comparative setting value L
- LL output : Display value  $\leq$  Comparative setting value LL
- ※1: GO output ON when there are no HH, H, L, LL outputs

### Block Output Mode [ブロック出力モード]

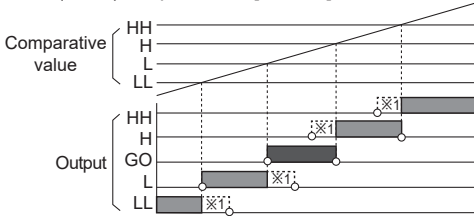

- HH output : Display value  $\geq$  Comparative setting value HH
- H output : Comparative setting value HH  $>$  Display value  $\geq$  Comparative setting value H
- L output : Comparative setting value LL  $<$  Display value  $\leq$  Comparative setting value L
- LL output : Display value  $\leq$  Comparative setting value LL
- ※1: GO output ON when there are no HH, H, L, LL outputs

### One-shot Output Mode [ワンショット出力モード]

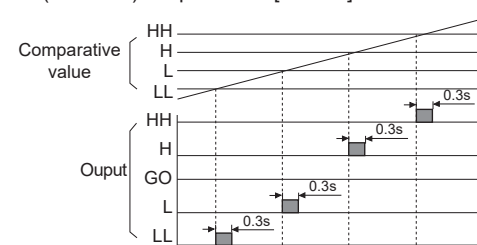

- HH output : Display value  $\geq$  Comparative setting value HH
- H output : Comparative setting value HH  $>$  Display value  $\geq$  Comparative setting value H
- L output : Comparative setting value H  $>$  Display value  $\geq$  Comparative setting value L
- LL output : Comparative setting value L  $>$  Display value  $\geq$  Comparative setting value LL
- ※No GO output
- ※One-shot output time is fixed at 0.3 sec.
- ※No hysteresis

### Deflection Output Mode [反転出力モード]

Transmits outputs when the saved setting value exceeds H deviation or L deviation.

- Saving setting value: press the **MODE**+**ENTER** keys to save as setting value.
- Checking setting value: press the **ENTER** key to check the setting value.
- Setting deviation: Sets H deviation [P5t. H], and L deviation [P5t. L] of parameter group 0,2 with the setting value as reference. (The set deviation value is saved during Power OFF until it is re-set.)
- Deviation setting range: 0.0001 to 99999 (the setting range varies depending on the decimal point [dpt] setting.)

E.g.) Decimal point [dpt]: 0000.0, Setting range: 0.1 to 9999.9

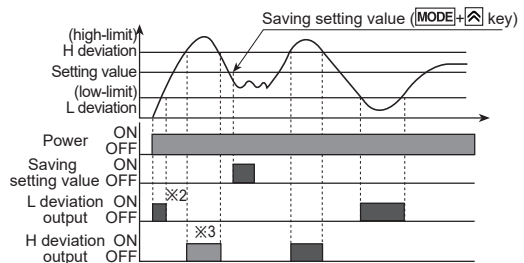

- ※2: When selecting initial comparative output limit function, it does not transmit outputs.
- ※3: The graph is assuming that there is a saved setting value prior to the setting value save point. The actual output position may be different.
- ※There are no HH, GO, LL outputs.
- ※The deviation can be set to "0" but the actual operation will be the same as "1".

## Function

### Hysteresis [HYS]

Near the comparative setting value, the output may turn ON/OFF frequently and unstably. To prevent this, hysteresis value is set based on the comparative setting value.

※A: hysteresis value

※The hysteresis value can be set to "0" but the actual operation value is "1".

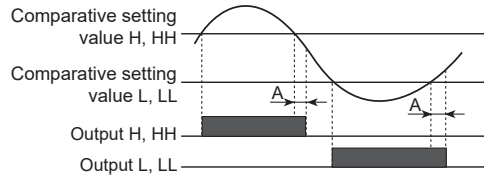

### Delay monitoring [GUARD]

After supplying power, the starting current of motors and other inputs are changeable. This function allows stable control by limiting all outputs for a certain period of time, until the target measurement unit stabilizes. It may also control L, LL outputs until a specific output is reached.

#### Comparative output limit function [dEFFY]

: Only for S (Standard), B (Block), F (Deflection) output mode.

: Limits L, LL output before H, HH output.

※Initial L, LL outputs does not operate, so GO output operates.

#### 1) During S (Standard) output mode

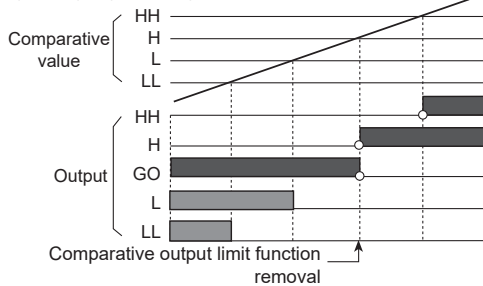

※After supplying power, there is no initial L, LL comparative outputs ( ).

※Each setting value of HH, H, LL, L is not related to their relative sizes. Hence, HH value may be lower or equal to LL value.

#### 2) During B (Block) output mode

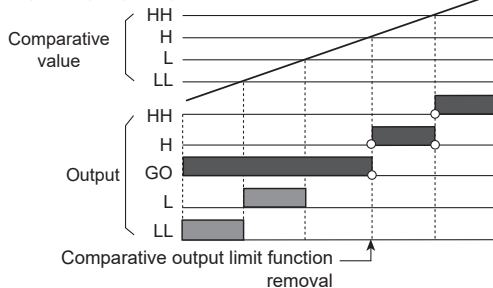

#### 3) During F (Deflection) output mode

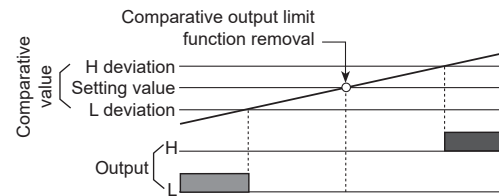

※After supplying power, there is no comparative output ( ) of L deviation.

※In F output mode, the comparative output limiting function is removed at the set value (standard setting)

※H and L deviation are not related to their relative sizes. (H deviation setting value > L deviation setting value, H deviation setting value < L deviation setting value)

### Start compensation timer function [Start]

Set monitoring delay time so that there is no output during the delay time.

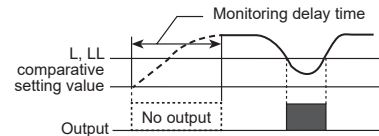

### Auto-zero time setting [AutoA, AutoB]

When there is no input signal during auto-zero setting time, the display value is automatically set to 0 (zero). Please set the auto-zero setting time so that it is longer than the interval of the slowest input signal. If the setting time is too long and there is no input signal, the rate at which the display value falls to 0 (zero) decrease, and output response rate may slow down.

### Data bank [PbA nE] (only for MP5W)

Comparative setting value and prescale value are saved as two types (data bank 1, 2) and can be selected for use by opening or shorting of terminals.

• Terminal 3, 5 open: use value of data bank 1

• Terminal 3, 5 short: use value of data bank 2

### Prescale [PSC.H, PSC.Y]

Displays values in required units or specific multiples by counting the number of input pulses, then multiplying the number of pulses or the length of pulses by variables (X×10y).

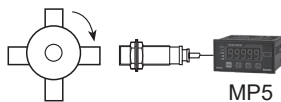

Number of revolutions (rpm) =  $f \times \alpha$

=  $f \times 60 \times (1 / N)$

=  $f \times 60 \times (1 / 4)$

=  $f \times 60 \times 0.25$

=  $f \times 15$

※f: The number of input pulses per second [Hz],

α: Prescale value

N: The number of pulses per revolution

• Setting prescale value (α=15)

Set mantissa (X) as 1.5000, and exponent (Y) as 1 for prescale value (α)=15.

The same display value can be obtained with α value set as X=0.1500, and Y=2.

SENSORS

CONTROLLERS

MOTION DEVICES

SOFTWARE

(J) Temperature Controllers

(K) SSRs

(L) Power Controllers

(M) Counters

(N) Timers

(O) Digital Panel Meters

(P) Indicators

(Q) Converters

(R) Digital Display Units

(S) Sensor Controllers

(T) Switching Mode Power Supplies

(U) Recorders

(V) HMIs

(W) Panel PC

(X) Field Network Devices

# MP5S/MP5Y/MP5W Series

## RS485 Communication Output

- Applicable for models with RS485 communication output through sub output (MP5Y□5, MP5W□8/9). Please refer to 'Ordering Information'.

### 1. Communication specifications

Comm. protocol	Modbus RTU	Communication Speed	2400, 4800, 9600 (default), 19200, 38400 bps
Connection type	RS485	Communication response time	5 to 99ms (default: 20ms)
Application standard	Compliance with EIA RS485	Start Bit	1-bit fixed
Max. connection	31 units (address: 01 to 99)	Data Bit	8-bit fixed
Synchronous method	Asynchronous	Parity Bit	None (default), Even, Odd
Comm. method	Two-wire half duplex	Stop Bit	1, 2-bit (default)
Comm. distance	Max. 800m		

### 2. System configuration

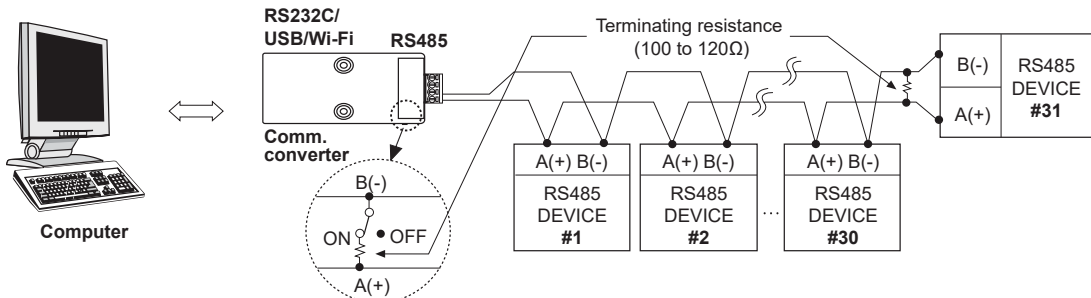

※It is recommended to use Autonics communication converter; SCM-WF48 (Wi-Fi to RS485-USB wireless communication converter, sold separately), SCM-US48I (USB to RS485 converter, sold separately), SCM-38I (RS232C to RS485 converter, sold separately). Please use twisted pair wire for RS485 communication.

### 3. Communication control sequence

- Communication sequence follows Modbus RTU protocol.
- Communication with the host system can be established after 1sec (1,000ms) of supplying power.
- The initial transmission authority is held by the host device (PC). When the host device transmits a request, the MP5W/Y Series sends a response.

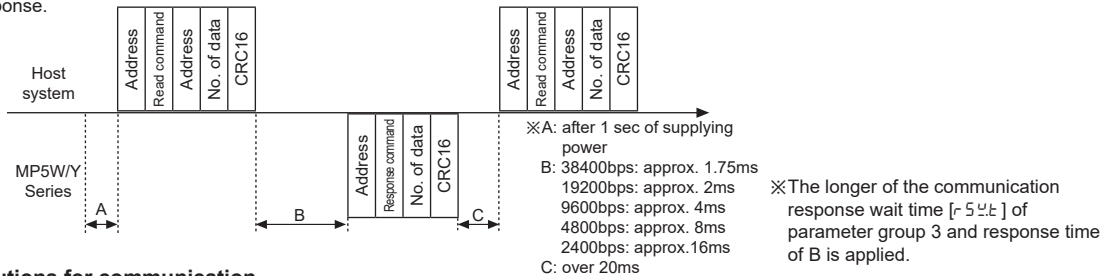

### 4. Cautions for communication

- Twisted pair cable (AWG24) is recommended for RS485 communication. When not using twisted pair cables, please make sure that A (+) and B (-) cable lengths are equal.
- After connecting the communication cable, terminating resistors (100 to 120Ω) must be attached at both ends.

### 5. Communication command and block definition

#### 5-1. Read coil status (func 01 H), read input status (func 02 H)

1) Query (Master)

Slave Address	Function (command)	Starting Address		No. of Points (no. of data)		Error Check (CRC 16)	
		High	Low	High	Low	Low	High
1Byte	1Byte	1Byte	1Byte	1Byte	1Byte	1Byte	1Byte

CRC16

2) Response (slave)

Slave Address	Function (command)	Byte Count (no. of data byte)	Data (low)	Data	Data (high)	Error Check (CRC 16)	
						Low	High
1Byte	1Byte	1Byte	1Byte	1Byte	1Byte	1Byte	1Byte

CRC16

#### 5-2. Read Holding registers (func 03 H), read input registers (func 04 H)

1) Query (Master)

Slave Address	Function (command)	Starting Address		No. of Points (no. of data)		Error Check (CRC 16)	
		High	Low	High	Low	Low	High
1Byte	1Byte	1Byte	1Byte	1Byte	1Byte	1Byte	1Byte

CRC16

## 2) Response (Slave)

Slave Address	Function (command)	Byte Count (no. of data byte)	Data		Data		Data		Error Check (CRC 16)	
			High	Low	High	Low	High	Low	Low	High
1Byte	1Byte	1Byte	1Byte	1Byte	1Byte	1Byte	1Byte	1Byte	1Byte	1Byte

← CRC16 →

## 5-3. Force single coil (func 05 H)

### 1) Query (Master)

Slave Address	Function (command)	Coil Address		Force Data		Error Check (CRC 16)	
		High	Low	High	Low	Low	High
1Byte	1Byte	1Byte	1Byte	1Byte	1Byte	1Byte	1Byte

← CRC16 →

### 2) Response (Slave)

Slave Address	Function (command)	Coil Address		Force Data		Error Check (CRC 16)	
		High	Low	High	Low	Low	High
1Byte	1Byte	1Byte	1Byte	1Byte	1Byte	1Byte	1Byte

← CRC16 →

## 5-4. Preset single register (func 06 H)

### 1) Query (Master)

Slave Address	Function (command)	Register Address		Preset Data		Error Check (CRC 16)	
		High	Low	High	Low	Low	High
1Byte	1Byte	1Byte	1Byte	1Byte	1Byte	1Byte	1Byte

← CRC16 →

### 2) Response (Slave)

Slave Address	Function (command)	Register Address		Preset Data		Error Check (CRC 16)	
		High	Low	High	Low	Low	High
1Byte	1Byte	1Byte	1Byte	1Byte	1Byte	1Byte	1Byte

← CRC16 →

## 5-5. Preset multiple registers (func 10 H)

### 1) Query (Master)

Slave Address	Function (command)	Starting Address		No. of Register		Byte Count	Data		Data		Error Check (CRC 16)	
		High	Low	High	Low		High	Low	High	Low	Low	High
		1Byte	1Byte	1Byte	1Byte	1Byte	1Byte	1Byte	1Byte	1Byte	1Byte	1Byte

← CRC16 →

### 2) Response (Slave)

Slave Address	Function (command)	Starting Address		No. of Register		Error Check (CRC 16)	
		High	Low	High	Low	Low	High
1Byte	1Byte	1Byte	1Byte	1Byte	1Byte	1Byte	1Byte

← CRC16 →

## 5-6. Exception response-error code (exception processing)

Slave Address	Function +80H	Exception code	Error Check (CRC 16)	
			Low	High
1Byte	1Byte	1Byte	1Byte	1Byte

← CRC16 →

• When a communication error occurs, the highest bit from the received command (function) is set (1), a response command is sent, and the corresponding exception code is transmitted.

- (1) ILLEGAL FUNCTION (exception code: 01 H)  
: Unsupported command
- (2) ILLEGAL DATA ADDRESS (exception code: 02 H)  
: The requested start address does not match the transmission address of the device.
- (3) ILLEGAL DATA VALUE (exception code: 03 H)  
: The number of requested data does not match the transmission number of the device.
- (4) SLAVE DEVICE FAILURE (exception code: 04 H)  
: The requested command cannot be processed properly. (CRC)

SENSORS
CONTROLLERS
MOTION DEVICES
SOFTWARE

(J) Temperature Controllers
(K) SSRs
(L) Power Controllers
(M) Counters
(N) Timers
(O) Digital Panel Meters
(P) Indicators
(Q) Converters
(R) Digital Display Units
(S) Sensor Controllers
(T) Switching Mode Power Supplies
(U) Recorders
(V) HMIs
(W) Panel PC
(X) Field Network Devices

# MP5S/MP5Y/MP5W Series

## 6. Address mapping table

### 6-1. Read coil status (func 01)

No.(Address)	Func	R/W	Parameter		Description	Setting range	Note
000001(0000)	01	R	HH	HH comparative output	Comparative output LED	0: OFF / 1: ON	
000002(0001)	01	R	H	H comparative output		0: OFF / 1: ON	
000003(0002)	01	R	GO	GO comparative output		0: OFF / 1: ON	
000004(0003)	01	R	L	L comparative output		0: OFF / 1: ON	
000005(0004)	01	R	LL	LL comparative output		0: OFF / 1: ON	
000006 to 000050	01	R	Reserved				

### 6-2. Read input status (func 02)

No.(Address)	Func	R/W	Parameter		Description	Setting range	Note
100001(0000)	02	R		RESET(HOLD)	External input variables	RESET input status	
100002(0001)	02	R		BANK		BANK input status	
100003 to 100050	02	R	Reserved				

### 6-3. Read input registers (func 04)

No.(Address)	Func	R/W	Parameter		Description	Factory default	Note
300001 to 300100	04	R	Reserved				
300101(0064)	04	R			Product number H	0	Dedicated model number
300102(0065)	04	R			Product number L	0	
300103(0066)	04	R			Hardware Version	1	
300104(0067)	04	R			Software Version	1	
300105(0068)	04	R			Model 1	"MP"	MP5□□5, MP5W□□8 (※MP5W□□9 displayed as MP5W□□8)
300106(0069)	04	R			Model 2	"5□"	
300107(006A)	04	R			Model 3	"□"	
300108(006B)	04	R			Model 4	"□"	
300109(006C)	04	R			Model 5	" "	
300110(006D)	04	R			Model 6	" "	
300111(006E)	04	R			Model 7	" "	
300112(006F)	04	R			Model 8	" "	
300113(0070)	04	R			Model 9	" "	
300114(0071)	04	R			Model 10	" "	
300115(0072)	04	R	Reserved				
300116(0073)	04	R	Reserved				
300117(0074)	04	R	Reserved				
300118(0075)	04	R			Coil Status Start Address	0000	
300119(0076)	04	R			Coil Status Quantity	0	
300120(0077)	04	R			Input Status Start Address	0000	
300121(0078)	04	R			Input Status Quantity	0	
300122(0079)	04	R			Holding Register Start Address	0000	
300123(007A)	04	R			Holding Register Quantity	0	
300124(007B)	04	R			Input Register Start Address	0000	
300125(007C)	04	R			Input Register Quantity	0	
300126 to 300200	04	R	Reserved				
No.(Address)	Func	R/W	Parameter		Description	Setting range	Note
301001(03E8)	04	R	HH H GO L LL	Front display LED	HH LED Display H LED Display GO LED Display L LED Display LL LED Display	0: OFF      1: ON 0: OFF      1: ON 0: OFF      1: ON 0: OFF      1: ON 0: OFF      1: ON	0 Bit 1 Bit 2 Bit 3 Bit 4 Bit
301002(03E9) 301003(03EA)	04	R	PV		Measurement value	-19999 to 99999	
301004(03EB)	04	R	DOT		Decimal point	0: 00000      3: 00000 1: 00000      4: 00000 2: 00000	
301005(03EC)	04	R	UNIT		Time range	0: 999.99s      5: 999.99m 1: 9999.9s      6: 9999.9m 2: 99m 59.9s      7: 99h 59.9m 3: 9h 59m 59s      8: 999h 59m 4: 99999s      9: 99999m	
301006(03ED)	04	R	MODE		Operation mode	0: F1      to 1: F2      14: F15 2: F3      15: F16	

## 6-4. Read holding registers (func 03) / Preset single register (func 06) / Preset multiple registers (func 16)

### 6-4-1. Comparative value settings and peak value check group

No.(Address)	Func	R/W	Parameter	Description	Setting range	Factory default
400001(0000)	03/16	R/W	P5t.HH	Preset HH	HH comparative value	0 to 99999
400002(0001)						99999
400003(0002)	03/16	R/W	P5t.H	Preset H	H comparative value	0 to 99999
400004(0003)						99999
400005(0004)	03/16	R/W	P5t.L	Preset L	L comparative value	0 to 99999 <sup>※1</sup>
400006(0005)						00000
400007(0006)	03/16	R/W	P5t.LL	Preset LL	LL comparative value	0 to 99999 <sup>※1</sup>
400008(0007)						00000
400009(0008)	03/16	R/W	HPEt	High Peak	High peak value of measured value	99999 <sup>※2</sup>
400010(0009)						—
400011(000A)	03/16	R/W	LPEt	Low Peak	Low peak value of measured value	-19999 <sup>※2</sup>
400012(000B)						—
400013 to 400050	03/06/16	R/W	Reserved			

※1: In operation modes F8, F10, F14, F15, the setting range is -19999 to 99999

※2: Max./Min. measurement value

### 6-4-2. Parameter 1 group

No.(Address)	Func	R/W	Parameter	Description	Setting range	Factory default
400051(0032)	03/06/16	R/W	āōdE	Mode	Input operation mode	0
400052(0033)	03/06/16	R/W	i n - ā	Input A	Sensor type	0
400053(0034)	03/06/16	R/W	i n - b	Input B		
400054(0035)	03/06/16	R/W	ōUt - t	Output type	Output mode	0
400055(0036)	03/06/16	R/W	HYS	Hysteresis	Hysteresis value	1 to 9999
400056(0037)	03/06/16	R/W	UtAr.d	Output limit	Output limit function	0
400057(0038)	03/06/16	R/W	StAr.t	Start limit value	Start compensation timer value	0.0 to 99.9
400058(0039)	03/16	R/W	Autōā	Auto-zero A	Auto-zero time	9999.9
400059(003A)	03/16	R/W				
400060(003B)	03/16	R/W	Autōb	Auto-zero B		
400061(003C)	03/16	R/W				
400062(003D)	03/06/16	R/W	āEāō	Memory	Memory retention	0
400063 to 400100	03/06/16	R/W	Reserved			

### 6-4-3. Parameter 2 group

No.(Address)	Func	R/W	Parameter	Description	Setting range	Factory default
400101(0064)	03/06/16	R/W	PbAn.t	Data bank	Data bank	0
400102(0065)	03/06/16	R/W	dōt	Dot	Decimal point	0
400103(0066)	03/06/16	R/W	t.Unt	Time unit	Time unit	0
400104(0067)	03/06/16	R/W	t.SEt	Time sec	Time range	0

SENSORS

CONTROLLERS

MOTION DEVICES

SOFTWARE

(J) Temperature Controllers

(K) SSRs

(L) Power Controllers

(M) Counters

(N) Timers

(O) Digital Panel Meters

(P) Indicators

(Q) Converters

(R) Digital Display Units

(S) Sensor Controllers

(T) Switching Mode Power Supplies

(U) Recorders

(V) HMIs

(W) Panel PC

(X) Field Network Devices



# MP5S/MP5Y/MP5W Series

## 6-4-3. Parameter 2 group

No.(Address)	Func	R/W	Parameter	Description	Setting range	Factory default	
400105(0068)	03/16	R/W	P5t.HH	Preset HH	HH comparative value	0 to 99999	
400106(0069)	03/16	R/W					
400107(006A)	03/16	R/W	P5t.H	Preset H	H comparative value	0 to 99999	
400108(006B)	03/16	R/W					
400109(006C)	03/16	R/W	P5t.L	Preset L	L comparative value	0 to 99999*1	
400110(006D)	03/16	R/W					
400111(006E)	03/16	R/W	P5t.LL	Preset LL	LL comparative value	0 to 99999*1	
400112(006F)	03/16	R/W					
400113(0070)	03/16	R/W	P5c.RH	Prescale A Mantissa	Prescale A mantissa	0.0001 to 9.9999	
400114(0071)	03/16	R/W					
400115(0072)	03/06/16	R/W	P5c.Ry	Prescale A Exponent	Prescale A exponent	00 to 09: + (0 to 9) 10 to 19: - (0 to 9)	01
400116(0073)	03/16	R/W	P5c.bH	Prescale B Mantissa	Prescale B mantissa	0.0001 to 9.9999	
400117(0074)	03/16	R/W					
400118(0075)	03/06/16	R/W	P5c.bY	Prescale B Exponent	Prescale B exponent	00 to 09: + (0 to 9) 10 to 19: - (0 to 9)	01
400119(0076)	03/06/16	R/W	d: 5P.t	Display time	Display cycle	0: 0FF 4: 2 1: 005 5: 4 2: 05 6: 8 3: 1	1
400120(0077)	03/16	R/W	C0U.n.b	INB Setting value	Operation mode F16 INB	1 to 99999	
400121(0078)	03/16	R/W					
400122 to 400150	03/06/16	R/W	Reserved				

\*1: In operation modes F8, F10, F14, F15, the setting range is -19999 to 99999

## 6-4-4. Parameter 3 group

No.(Address)	Func	R/W	Parameter	Description	Setting range	Factory default	
400151(0096)	03/16	R/W	F5-H	Full scale High	Setting range varies by model and operation mode*1	99999	
400152(0097)		R/W	F5-L	Full scale Low		0	
400153(0098)	03/16	R/W	nA	mA	Transmission output spec.	0: 4-20 (mA) 1: 0-20 (mA)	
400154(0099)		R/W					
400155(009A)	03/06/16	R/W	Addr	Unit address	Communication address	1 to 99	1
400157(009C)	03/06/16	R/W	bP5	Bit per Sec	Communication Speed	0: 2400 1: 4800 2: 9600 3: 19200 4: 38400	2
400158(009D)	03/06/16	R/W	P.r.t.y	Parity bit	Communication parity bit	0: none 1: Even 2: odd	0
400159(009E)	03/06/16	R/W	5.t.P	Stop bit	Communication stop bit	0: 1 1: 2	1
400160(009F)	03/06/16	R/W	r.5.u.t	Response waiting time	Communication response waiting time	5 to 99(ms)	20
400161(00A0)	03/06/16	R/W	C0n.n.y	Communication write	Communication write enable/disable	0: d: 5R 1: EnR	0
400162(00A1)	03/06/16	R/W	L.o.C	Lock	Lock	0: 0FF 1: L.o.C.0 2: L.o.C.1 3: L.o.C.2 4: L.o.C.3	0
400163 to 400200	03/06/16	R/W	Reserved				

\*1: High-limit/low-limit setting value of PV transmission output. (varies by model and operation mode)

Series	Operation mode	Setting range
MP5Y	F1, F2, F7, F9, F11, F12, F13, F16	0 to 99999
	F3, F4, F5, F6	0.01 to set time range
MP5W	F8, F10, F14, F15	-19999 to 99999

## ■ Comprehensive Device Management Program (DAQMaster)

- DAQMaster is comprehensive device management program for convenient management of parameters and multiple device data monitoring.
- Visit our website ([www.autonics.com](http://www.autonics.com)) to download user manual and comprehensive device management program.

< Computer specification for using software >

Item	Minimum requirements
System	IBM PC compatible computer with Intel Pentium III or above
Operations	Microsoft Windows 98/NT/XP/Vista/7/8/10
Memory	256MB+
Hard disk	1GB+ of available hard disk space
VGA	Resolution: 1024×768 or higher
Others	RS-232 serial port (9-pin), USB port

< DAQMaster screen >

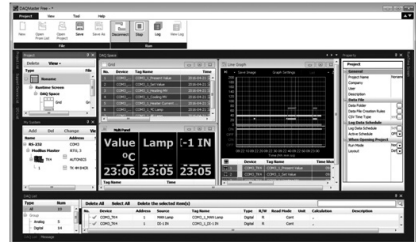

## ■ Proper Usage

### ⚠ Cautions during use

1. Follow instructions in 'Cautions during Use'. Otherwise, it may cause unexpected accidents.
2. 24VAC, 24-48VDC power supply should be insulated and limited voltage/current or Class 2, SELV power supply device.
3. Install a power switch or circuit breaker in the easily accessible place for supplying or disconnecting the power.
4. Keep away from high voltage lines or power lines to prevent inductive noise.  
In case installing power line and input signal line closely, use line filter or varistor at power line and shielded wire at input signal line.  
Do not use near the equipment which generates strong magnetic force or high frequency noise.
5. This unit may be used in the following environments.
  - ① Indoors (in the environment condition rated in 'Specifications')
  - ② Altitude max. 2,000m
  - ③ Pollution degree 2
  - ④ Installation category II

SENSORS

CONTROLLERS

MOTION DEVICES

SOFTWARE

(J)  
Temperature  
Controllers

(K)  
SSRs

(L)  
Power  
Controllers

(M)  
Counters

(N)  
Timers

(O)  
Digital  
Panel Meters

(P)  
Indicators

(Q)  
Converters

(R)  
Digital  
Display Units

(S)  
Sensor  
Controllers

(T)  
Switching  
Mode Power  
Supplies

(U)  
Recorders

(V)  
HMIs

(W)  
Panel PC

(X)  
Field Network  
Devices