



Continual operation requires high operational reliability in the components used. The DILM contactor achieves the best lifespan values in AC-3 applications and is ideal for heavy AC-4 jogging.

Lhmh bnms`bsnq qdk`x CHKDA+bnms`bsnq qdk`xr+ bnms`bsnqr to sn 01 @ @B,2 `s 3//U  
Compact dimensions for the highest packing densities +++ Extended performance range up to 5.5 kW at 400 V

@B `mc CB bnms`bsnq rxrsdl CHKLÀ+ bnms`bsnq qdk`xr+ 2 onkd bnms`bsnqr to sn 06/ @ @B,2 `s 3//U+ 3 onkd bnms`bsnqr to sn 1// @ @B,0

Easier engineering through identical construction sizes for AC- and DC-operated contactors +++ Energy savings and higher packing density in control panel due to minimized heat dissipation +++ High wiring security through doubled box terminals +++ Less coupler relays: direct actuation from the PLC for contactors up to 32 A +++ Easy engineering through integrated suppressor circuits for DC +++ Uniform accessories for 3- and 4-pole contactors +++ Mechanical interlock double conductor run mountable without additional separation gap +++ Direct fieldbus connection through the communication system SmartWire-Darwin, through plug-in type protective module

Ghfg q`sdcb bnms`bsnqr , bnms`bsnqr to sn 05// @ @B,2 `s 3//U+ bnms`bsnqr to sn 15// @ @B,0

Compact dimensions with high switching power +++ Direct actuation from the PLC saves coupler relays +++ Easy engineering through wide range coils +++ Cost and energy savings for control panel ventilation due to reduced heat dissipation +++ Long lifespan through vacuum technology from 580 A

Rl`qsVhqd,C`qvhm

The DIL product range offers contact elements which can be connected to the SmartWire-Darwin communication system.  $\psi$  Protective modules, Page 5/62



D`snm @esdq R`kdr Rdquhbd

Testing switching devices in compliance with regulations applicable to this technology  $\psi$  Chapter 22





## Ordering

### Mini contactor relays DILER, DILEEM, DILEM

Mini contactor relays, contactors	5/2
Auxiliary contact modules	5/6
Accessories	5/8
Actuating voltages	5/70

### DILA contactor relays

Contactor relays	5/10
Auxiliary contact modules	5/12
Actuating voltages	5/72

## Technical overview

Contactors DILM, DILH	5/14
-----------------------	------

## System overview

Contactors DILM, DILH	5/16
-----------------------	------

## Ordering

### Contactors DILM, DILH

Basic devices up to 170 A	5/18
Complete units up to 170 A	5/24
Contactors up to 150 A with electronic actuation	5/28
Standard devices greater than 170 A	5/30
Comfort devices greater than 170 A	5/32
Basic devices up to 200 A, 4 pole	5/36
Auxiliary contact modules	5/38

## Engineering

Auxiliary contact modules	5/42
---------------------------	------

## Ordering

DILK contactors for capacitors	5/43
--------------------------------	------

## Engineering

Contactors for power factor correction	5/44
--	------

## Ordering

Lighting contactors DILL	5/45
--------------------------	------

## Engineering

Lighting systems	5/46
------------------	------

## Ordering

Star-delta combinations SDAINL	5/48
--------------------------------	------

## Engineering

Star-delta combinations SDAINL	5/50
--------------------------------	------

## Ordering

DIUL reversing combinations	5/52
-----------------------------	------

## Description

CMD contactor monitoring device	5/68
---------------------------------	------

## Ordering

CMD contactor monitoring device	5/68
---------------------------------	------

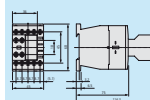
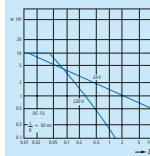
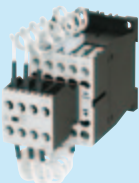

## Ordering

### DILM contactor relays, DILM, DILH contactors

Suppressor circuit	5/54
Accessories	5/56

## Ordering

### Actuating voltages contactors DILM, DILH

Basic devices up to 170 A	5/73
Basic devices up to 200 A, 4 pole	5/78
Contactors up to 150 A with electronic actuation	5/80
Replacement coils	5/75
Comfort devices greater than 170 A	5/81
Standard devices greater than 170 A	5/81
Electronic modules including coil	5/81
Contactors for capacitors	5/80

## Engineering

Contact travel diagrams	5/82
Enclosure	5/83
UL/CSA-Approved rating data	5/84
UL/CSA Special Purpose Ratings	5/85
UL/CSA Short Circuit Current Rating	5/86
Contactors for resistive loads	5/88
Electrical life span	5/90
Short-time loading	5/94
Operating frequency	5/95
Switching of DC current	5/96

## Technical data

Mini contactor relays, contactor relays	5/97
Contactor monitoring device	5/100
Basic devices up to 170 A	5/108
Basic devices up to 200 A, 4 pole	5/124
Comfort devices greater than 170 A	5/116
Standard devices greater than 170 A	5/116
Contactors for capacitors	5/127
Contactors up to 150 A with electronic actuation	5/130
Lighting contactors	5/129
Auxiliary contact modules	5/132
Accessories	5/133

## Dimensions

Mini contactor relays	5/134
Contactor relays	5/135
Basic devices up to 170 A	5/135
Basic devices up to 200 A, 4 pole	5/137
Contactors larger than 170 A	5/138
Contactors for capacitors	5/140
Lighting contactors	5/140
Contactor combinations	5/141
Accessories	5/142

**Ordering**

Rated operational current AC-15		Conventional free air thermal current	Contact N/O = normally open contact NC = normally closed contact	Distinctive number	Circuit symbol	For use with
220 V	380 V					
230 V	400 V	$I_{th}$ A				
240 V	415 V					
$I_e$ A	$I_e$ A					

**DILER mini contactor relays**

Screw terminals

6	3	10	4 N/O	—	40E		DILE...
			3 N/O	1 NC	31E		DILE...
			2 N/O	2 NC	22E		DILE...

**Notes**

Coil terminal marking as specified in EN 50005  
Contact numbers to EN 50011  
The following applies to DC-operated contactors:  
• Integrated diode-resistor combination  
• Coil rating 2.6 W

**Information relevant for export to North America**



Product Standards

UL File No.  
UL CCN  
CSA File No.  
CSA Class No.  
NA Certification

IEC/EN 60947-4-1; UL 508; CSA-C22.2 No. 14-05;  
CE marking  
E29184  
NKCR  
012528  
3211-03  
UL Listed,  
CSA certified

AC operation Part no. Article no.	Price See price list	DC operation Part no. Article no.	Price See price list	Std. pack	Notes
<b>DILER-40(230V50HZ)</b> 051759		<b>DILER-40-G(24VDC)</b> 010223		5 off 	<b>With screw terminals:</b>   <b>Accessories</b> 1 Suppressor → 5/8 2 Auxiliary contact modules → 5/6 Further actuating voltages → 5/70
<b>DILER-31(230V50HZ)</b> 051768		<b>DILER-31-G(24VDC)</b> 010157			
<b>DILER-22(230V50HZ)</b> 051777		<b>DILER-22-G(24VDC)</b> 010042			

Rated operational current	Max. motor rating for three-phase motors, 50 - 60 Hz						Conventional thermal current $I_{th} = I_e$ AC-1 at 50 °C		Contact	Circuit symbol	For use with
	AC-3	AC-3		AC-4		Open	Enclosed				
380 V 400 V	220 V 230 V	<b>380 V</b> <b>400 V</b>	660 V 690 V	220 V 230 V	<b>380 V</b> <b>400 V</b>	660 V 690 V	$I_{th} = I_e$	$I_{th} = I_e$	N/O = normally open contact NC = normally closed contact		
$I_e$	P	<b>P</b>	P	P	<b>P</b>	P	A	A			
	<b>A</b>	kW	<b>kW</b>	kW	kW	<b>kW</b>	kW				

**DILEM contactors**

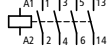
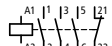
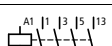
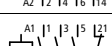
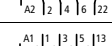
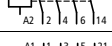

3 pole with auxiliary contact

Screw terminals

	<b>6.6</b>	1.5	<b>3</b>	3	1.1	<b>2.2</b>	2.2	20	16	1 N/O	—		...DILEM DILE...
	<b>6.6</b>	1.5	<b>3</b>	3	1.1	<b>2.2</b>	2.2	20	16	—	1 NC		DILE...
	<b>9</b>	2.2	<b>4</b>	4	1.5	<b>3</b>	3	20	16	1 N/O	—		...DILEM DILE...
	<b>9</b>	2.2	<b>4</b>	4	1.5	<b>3</b>	3	20	16	—	1 NC		DILE...
	<b>12</b>	3.5	<b>5.5</b>	6.5	2	<b>3</b>	2.2	20	16	1 N/O	—		...DILEM DILE...
	<b>12</b>	3.5	<b>5.5</b>	6.5	2	<b>3</b>	2.2	20	16	—	1 NC		DILE...

4 pole

Screw terminals

	<b>9</b>	2.2	<b>4</b>	4	1.5	<b>3</b>	3	20	16	—	—		...DILEM DILE...
--	----------	-----	----------	---	-----	----------	---	----	----	---	---	--	---------------------

1)

**Information relevant for export to North America**



Product Standards

IEC/EN 60947-4-1;  
UL 508; CSA-C22.2  
No. 14-05; CE marking  
UL File No. E29096  
UL CCN NLDX  
CSA File No. 012528  
CSA Class No. 3211-04  
NA Certification UL Listed, CSA certified  
See also → Page 5/84

2)

**Information relevant for export to North America**



Product Standards

IEC/EN 60947-4-1;  
UL 508; CSA-C22.2 No. 14-05; CE marking  
UL File No. E29096  
UL CCN NLDX  
CSA File No. 012528  
CSA Class No. 2411-03, 3211-04  
NA Certification UL Listed, request filed for CSA

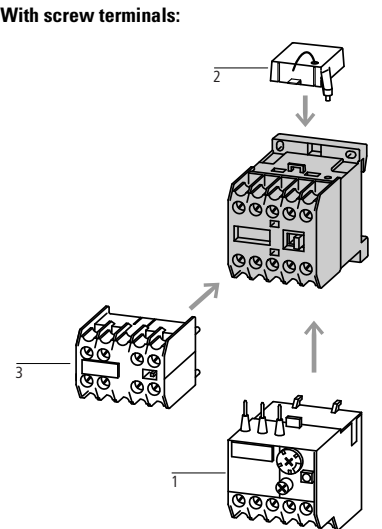
AC operation Part no. Article no.	Price See price list	DC operation Part no. Article no.	Price See price list	Std. pack	Notes
<b>DILEEM-10(230V50HZ)<sup>1)</sup></b> 051608		<b>DILEEM-10-G(24VDC)<sup>1)</sup></b> 051643		5 off 	<p><b>With screw terminals:</b></p>  <p><b>Accessories</b> 1 Overload relay 2 Suppressor 3 Auxiliary contact module Enclosures <span style="border: 1px solid black; padding: 1px;">totally insulated</span> Further actuating voltages Accessories</p> <p><b>Page</b> → Chapter 6 → 5/8 → 5/6 → 5/70 → 5/8</p>
<b>DILEEM-01(230V50HZ)<sup>1)</sup></b> 051633		<b>DILEEM-01-G(24VDC)<sup>1)</sup></b> 051650			
<b>DILEM-10(230V50HZ)<sup>1)</sup></b> 051786		<b>DILEM-10-G(24VDC)<sup>1)</sup></b> 010213			
<b>DILEM-01(230V50HZ)<sup>1)</sup></b> 051795		<b>DILEM-01-G(24VDC)<sup>1)</sup></b> 010343			
<b>DILEM12-10(230V50HZ)<sup>2)</sup></b> 127075		<b>DILEM12-10-G(24VDC)<sup>2)</sup></b> 127132			
<b>DILEM12-01(230V50HZ)<sup>2)</sup></b> 127091		<b>DILEM12-01-G(24VDC)<sup>2)</sup></b> 127137			
<b>DILEM4(230V50HZ)<sup>1)</sup></b> 051804		<b>DILEM4-G(24VDC)<sup>1)</sup></b> 012701		5 off 	

Contact	Rated operational current		Conventional thermal current	Distinctive number/type of combinations with basic device		
N/O = normally open contact S <sub>F</sub> = NO early-make NC = normally closed contact Ö <sub>S</sub> = NC late-break	AC-15		I <sub>th</sub>	DILER-40(-G)	DILER-31(-G)	DILER-22
	220 V	380 V	A			
	230 V	400 V				
	240 V	415 V				
	I <sub>e</sub>	I <sub>e</sub>				
	A	A				

Auxiliary contact modules

Screw terminals











Pole	Contact	Rated operational current	Conventional thermal current	Distinctive number/type of combinations with basic device	Distinctive number/type of combinations with basic device	Distinctive number/type of combinations with basic device
2 pole	– – 2 NC –	4	2	10	–	–
	1 N/O – 1 NC –	4	2	10	–	–
	– – – –	4	2	10	–	–
4 pole	2 N/O – 2 NC –	4	2	10	–	–
	– – 2 NC –	4	2	10	42E	33
	1 N/O – 1 NC –	4	2	10	51E	42
	2 N/O – – –	4	2	10	60E	51
2 pole	– – 2 NC –	4	2	10	42E	33
	1 N/O – 1 NC –	4	2	10	51E	42
	2 N/O – – –	4	2	10	60E	51
	– 1 S <sub>F</sub> – 1 Ö <sub>S</sub>	4	2	10	51	42
	– – 4 NC –	4	2	10	44E	35
	1 N/O – 3 NC –	4	2	10	53E	44
	2 N/O – 2 NC –	4	2	10	62E	53
4 pole	3 N/O – 1 NC –	4	2	10	71E	62
	4 N/O – – –	4	2	10	80E	71
	1 N/O 1 S <sub>F</sub> 1 NC 1 Ö <sub>S</sub>	4	2	10	62	53
	– – – –	4	2	10	–	–
	– – – –	4	2	10	–	–







Information relevant for export to North America

Product Standards	IEC/EN 60947-4-1; UL 508; CSA-C22.2 No. 14-05;
UL File No.	E29184
UL CCN	NKCR
CSA File No.	012528
CSA Class No.	3211-03
NA Certification	UL Listed, CSA certified



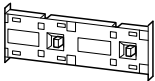

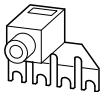

Circuit symbol	Can be combined with contactor	Part no. Article no.	Price See price list	Std. pack	Notes
	DILEM-10(-G)(...) DILEM-4(-G)(...) DILEEM-10(-G)(...) DILEM12-10(-G)(...)	<b>02DILE</b> 010064		5 off	With interlocked opposing contacts           The following applies to ...DILEM auxiliary contacts: • Contacts to EN 50012 The following applies to ...DILE auxiliary contacts: • Contacts to EN 50005  Contacts according to EN50012 are to be preferred. Type E combinations comply with EN 50011 and are to be given preference.  No interlocked opposing contacts in NO early-makes and NC late-breaks.
		<b>11DILE</b> 010080			
		<b>22DILE</b> 010112			
	DILEM-10(-G)(...) DILEM-01(-G)(...) DILEM-4(-G)(...)	<b>02DILE</b> 010240			
	DILER40(-G) DILER31(-G) DILER22	<b>11DILE</b> 010224			
	DILEEM-10(-G)(...) DILEEM-01(-G)(...) DILEM12-10(-G)(...) DILEM12-01(-G)(...)	<b>20DILE</b> 010208			
		<b>11DDILE</b> 049824			
		<b>04DILE</b> 010256			
		<b>13DILE</b> 002397			
		<b>22DILE</b> 010288			
		<b>31DILE</b> 048912			
		<b>40DILE</b> 010304			
		<b>22DDILE</b> 049823			

Actuating voltage U <sub>s</sub> V AC	Circuit symbol	For use with	Part no. Article no.	Price See price list	Std. pack	Information relevant for export to North America 
<b>Suppressor circuits</b>						
<b>Varistor suppressor</b>						
	24 - 48 AC 110 - 250 AC 380 - 415 AC		DILE...	VGDILE48 010320 VGDILE250 010336 VGDILE415 010463	10 off 	Product Standards IEC/EN 60947-4-1; UL 508; CSA-C22.2 No. 14-05; CE marking UL File No. E29096 UL CCN NLDX CSA File No. 012528 CSA Class No. 3211-03 NA Certification UL Listed, CSA certified
<b>RC-Suppressor</b>						
	24 - 48 AC 110 - 250 AC		DILE...	RCDILE48 044264 RCDILE250 046320	10 off  10 off 	Product Standards IEC/EN 60947-4-1; UL 508; CSA-C22.2 No. 14-05; CE marking UL File No. E29184 UL CCN NKCR2 CSA File No. - NA Certification UL Recognized

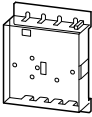
**Notes** For AC operated contactors 50 - 60 Hz.  
DC operated contactor relays have an integrated suppressor.  
Note drop-out delay.

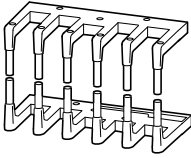
		For use with	Part no. Article no.	Price See price list	Std. pack	Information relevant for export to North America 
<b>Mechanical interlocks</b>						
For mechanical connection of contactor and timing relays in combinations. 0 mm distance between contactors.						
		DILE... DILET...	VODILE 026634		50 off 	UL/CSA certification not required
<b>Mechanical interlock</b>						
For contactors with the same or different magnet system. 0 mm distance between contactors. Mechanical lifespan 2.5 x 10 <sup>6</sup> operations. Additional auxiliary contact modules possible.						
	-	DILE...	MVDILE 010113		5 off 	Product Standards IEC/EN 60947-4-1; UL 508; CSA-C22.2 No. 14-05; CE marking UL File No. E29184 UL CCN NKCR2 CSA File No. 012528 CSA Class No. 3211-07 NA Certification UL Recognized, CSA certified
<b>Paralleling link</b>						
For parallel connection of contacts						
	-	DILE... DILE...	BT480 <sup>2)</sup> 052785		100 off	Product Standards IEC/EN 60947-4-1; UL 508; CSA-C22.2 No. 14-05; CE marking UL File No. E29096 UL CCN NLDX CSA File No. 012528 CSA Class No. 3211-07 NA Certification UL Listed, CSA certified
Consisting of two four-pole paralleling links.						
		DILEEM DILEM12 DILEM	P1DILEM <sup>2)</sup> 019095		5 off 	UL Listed, CSA certified

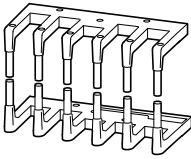
**Notes** 1) Not protected against accidental contact as specified in VDE 0106 Part 100.  
2) 4th pole can be broken off  
4 pole: I<sub>th</sub> = 60 A open  
3 pole: I<sub>th</sub> = 50 A open  
AC-1 current carrying capacity of the open contactor increases by a factor of 2.5  
Protected against accidental contact in accordance with VDE 0106 Part 100

Contact sequence	For use with	Part no. Article no.	Price See price list	Std. pack	Information relevant for export to North America 
<b>Sealable shrouds</b>					
Transparent Snap-fitting on contactor. Can be used with open installation or on service distribution board. Protection type: IP40 front Can be drilled to accommodate timing relay setting dials.					
	DILE... DILET...	<b>HDILE</b> 010482		1 off 	UL/CSA certification not required
<b>Start-point bridge</b>					
	DILEEM DILEM12 DILEM	<b>S1DILEM<sup>1)</sup></b> 220218		20 off	
<b>Reversing starter wiring kit</b>					
Main current wiring for reversing combinations					
	DILEEM (+MVDILEM) DILEM12 (+MVDILEM) DILEM (+MVDILEM)	<b>MVS-WB-EM<sup>2)</sup></b> 220209		1 off 	Product Standards IEC/EN 60947-4-1; UL 508; CSA-C22.2 No. 14-05; CE marking UL File No. E36332 UL CCN NLRV7 CSA File No. 012528 CSA Class No. 3211-06 NA Certification UL Listed, CSA certified
<b>Star-delta wiring kit</b>					
Main current wiring for star-delta combination incl. star-point bridge					
	DILE(E)M (+MVDILEM) DILE(E)M12 (+MVDILEM) DILE(E)M star contactor	<b>MVS-SB-EM<sup>3)</sup></b> 220213		1 off 	Product Standards IEC/EN 60947-4-1; UL 508; CSA-C22.2 No. 14-05; CE marking UL File No. E36332 UL CCN NLRV7 CSA File No. 012528 CSA Class No. 3211-06 NA Certification UL Listed, CSA certified



**Notes**

- <sup>1)</sup> Protected against accidental contact in accordance with VDE 0106 Part 100
- <sup>2)</sup> The following control cables are integrated in addition to electrical interlock:
  - Q11: A1 - Q12: 21
  - Q11: 21 - Q12: A1
  - Q11: A2 - Q12: A2
 For use with overload relay separate mounting.
- <sup>3)</sup> The following control cables are integrated in addition to electrical interlock:
  - Q13: A1 - Q15: 21
  - Q13: 21 - Q15: A1
  - Q13: A2 - Q15: A2
 For use with overload relay separate mounting.

Contact	Rated operational current	Conventional thermal current	Distinctive number	Can be combined with auxiliary contact	Circuit symbol
N/O = normally open contact NC = normally closed contact	AC-15	$I_{th}$			
	220 V 230 V 240 V	380 V 400 V 415 V			
	$I_e$ A	$I_e$ A			

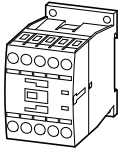
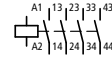
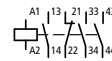
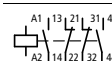
Basic devices with positively driven contacts

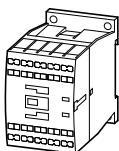

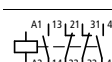





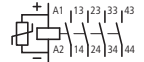

Screw terminals								
	4 N/O	-	4	4	16	40E	DILA-XHI(V)...	
	3 N/O	1 NC				31E	DILA-XHI(V)...	
	2 N/O	2 NC				22E	DILA-XHI(V)...	

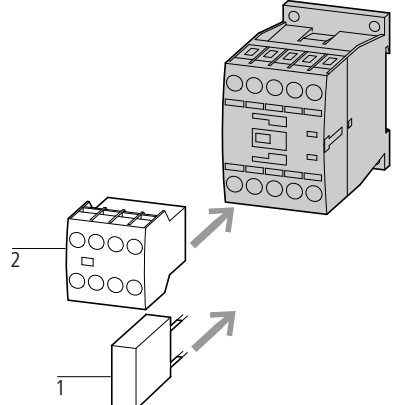
Spring-loaded terminals								
	4 N/O	-	4	4	16	40E	DILA-XHIC(V)...	
	3 N/O	1 NC				31E	DILA-XHIC(V)...	
	2 N/O	2 NC				22E	DILA-XHIC(V)...	

Notes  
 Contact numbers to EN 50011  
 Coil terminal markings to EN 50005  
 The following applies to DC-operated contactors:  
 • Integrated suppressor circuit

Information relevant for export to North America

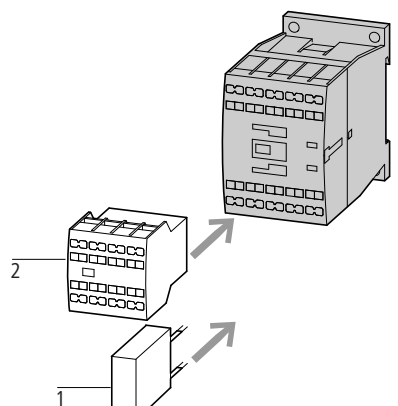
Information relevant for export to North America	
	
Product Standards	IEC/EN 60947-4-1; UL 508; CSA-C22.2 No. 14-05; CE marking
UL File No.	E29184
UL CCN	NKCR
CSA File No.	012528
CSA Class No.	3211-03
NA Certification	UL Listed, CSA certified

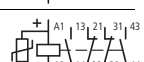
AC operation	Price	Std. pack	Circuit symbol	DC operation	Price	Std. pack	Notes
Part no. Article no.	See price list			Part no. Article no.	See price list		
<b>DILA-40(230V50HZ)</b> 276329		1 off 		<b>DILA-40(24VDC)</b> 276344		1 off 	<b>With screw terminals:</b> 
<b>DILA-31(230V50HZ)</b> 276364				<b>DILA-31(24VDC)</b> 276379			
<b>DILA-22(230V50HZ)</b> 276399				<b>DILA-22(24VDC)</b> 276414			
<b>DILAC-40(230V50HZ)</b> 276441		1 off 		<b>DILAC-40(24VDC)</b> 276456		1 off 	<b>With spring-loaded terminals:</b> 
<b>DILAC-31(230V50HZ)</b> 276473				<b>DILAC-31(24VDC)</b> 276488			
<b>DILAC-22(230V50HZ)</b> 276505				<b>DILAC-22(24VDC)</b> 276520			

**Accessories**  
 1 Suppressor → 5/54  
 2 Auxiliary contact modules → 5/38  
 Further actuating voltages → 5/72

**Accessories**  
 1 Suppressor → 5/54  
 2 Auxiliary contact modules → 5/38  
 Further actuating voltages → 5/72



Contact	Rated operational current		Conventional thermal current	Circuit symbol
N/O = normally open contact S <sub>F</sub> = NO early-make NC = normally closed contact Ö <sub>S</sub> = NC late-break	AC-15			
	220 V	380 V	I <sub>th</sub>	
	230 V	400 V		
	240 V	415 V		
	I <sub>e</sub>	I <sub>e</sub>		
	A	A	A	

DILA auxiliary contact modules

Screw terminals



Pole	Contact	Rated operational current	Conventional thermal current	Circuit symbol
2 pole	2 NC	4	4	16
	1 N/O	4	4	16
	2 N/O	4	4	16
	1 S <sub>F</sub>	4	4	16
4 pole	4 NC	4	4	16
	1 N/O	4	4	16
	2 N/O	4	4	16
	3 N/O	4	4	16
	4 N/O	4	4	16
	1 N/O 1 S <sub>F</sub>	4	4	16

Spring-loaded terminals



Pole	Contact	Rated operational current	Conventional thermal current	Circuit symbol
2 pole	2 NC	4	4	16
	1 N/O	4	4	16
	2 N/O	4	4	16
	1 S <sub>F</sub>	4	4	16
4 pole	4 NC	4	4	16
	1 N/O	4	4	16
	2 N/O	4	4	16
	3 N/O	4	4	16
	4 N/O	4	4	16
	1 N/O 1 S <sub>F</sub>	4	4	16

Information relevant for export to North America



Product Standards IEC/EN 60947-4-1; UL 508; CSA-C22.2 No. 14-05; CE marking  
 UL File No. E29184  
 UL CCN NKCR  
 CSA File No. 012528  
 CSA Class No. 3211-03  
 NA Certification UL Listed, CSA certified

Distinctive number/type of combinations	Part no. Article no.	Price See price list	Std. pack	Description	Notes
DILA(C)-40	DILA(C)-31	DILA(C)-22			
42E	33	24	5 off	With interlocked opposing contacts	Type E combinations comply with EN 50011 and must be given preference. The other combinations comply with EN 50005. The DC operated contactor DILA(C)-22 must only be combined with 2 pole auxiliary contacts.
51E	42	33			
60E	51	42			
51	42	33			
44E	35	26		With interlocked opposing contacts	
53E	44	35			
62E	53	44			
71E	62	53			
80E	71	62			
62	53	44			
42E	33	24	5 off	With interlocked opposing contacts	Type E combinations comply with EN 50011 and must be given preference. The other combinations comply with EN 50005. The DC operated contactor DILA(C)-22 must only be combined with 2 pole auxiliary contacts.
51E	42	33			
60E	51	42			
51	42	33			
44E	35	26		With interlocked opposing contacts	
53E	44	35			
62E	53	44			
71E	62	53			
80E	71	62			
62	53	44			

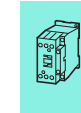

DILM, DILE(E)M, DILMP

Technical overview

Contactors  
3 pole

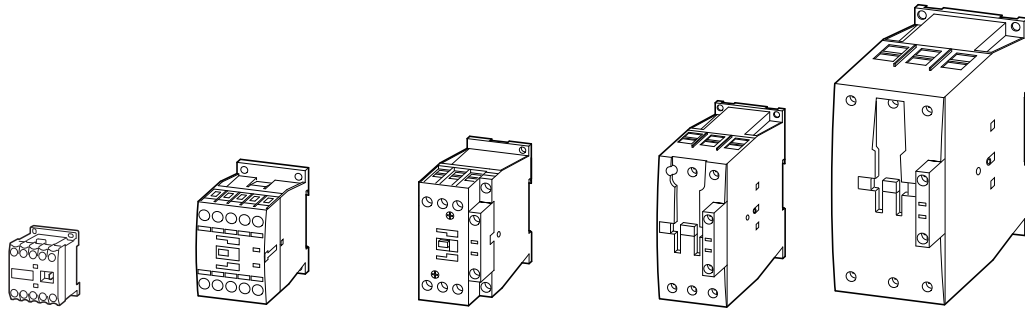

<b>DIL</b>		<b>EEM</b>	<b>EM</b>	<b>EM12</b>	<b>M7</b>	<b>M9</b>	<b>M12</b>	<b>M15</b>	<b>M17</b>	<b>M25</b>	<b>M32</b>	<b>M38</b>	<b>M40</b>	<b>M50</b>	<b>M65</b>	<b>M80</b>	<b>M95</b>	<b>M115</b>	<b>M150</b>	<b>M170</b>
Basic devices	Page	→ 5/4		→ 5/18			→ 5/18			→ 5/20			→ 5/50							
Complete units	Page	-			→ Page 5/24			-			→ Page 5/24			→ Page 5/26			→ Page 5/26			

Rated-operational voltage	kW	kW	kW	kW	kW	kW	kW	kW	kW	kW	kW	kW	kW	kW	kW	kW	kW	kW	kW	kW
<b>AC-3</b> Rated operational power for 3-phase motors 50–60 Hz																				
220 V – 230 V	1.5	2.2	3	2.2	2.5	3.5	4	5	7.5	10	11	12.5	15.5	20	25	30	37	48	52	
<b>380 V – 400 V</b>	<b>3</b>	<b>4</b>	<b>5.5</b>	<b>3</b>	<b>4</b>	<b>5.5</b>	<b>7.5</b>	<b>7.5</b>	<b>11</b>	<b>15</b>	<b>18.5</b>	<b>18.5</b>	<b>22</b>	<b>30</b>	<b>37</b>	<b>45</b>	<b>55</b>	<b>75</b>	<b>90</b>	
440 V	3.3	4.6	5.5	4.5	5.5	7.5	8.4	10.5	15.5	20	21	25	32	41	51	60	75	95	105	
500 V	3	4	5.5	3.5	4.5	7	7.5	12	17.5	23	24	28	36	47	58	70	85	110	120	
660 V/690 V	3	4	4	3.5	4.5	6.5	7	11	14	17	21	23	30	35	63	75	90	96	140	
1000 V	-	-	-	-	-	-	-	-	-	-	-	-	-	-	-	-	-	-	-	
<b>AC-4</b> Rated operational power for 3-phase motors 50–60 Hz																				
	▲ Increase in life span for DILM7 – DILM150 to 200000 operations																			
220 V – 230 V	1.1	1.5	1.5	1	1.5	2	2	2.5	3.5	4	4	5	6	7	12	16	17	20	20	
<b>380 V – 400 V</b>	<b>2.2</b>	<b>3</b>	<b>3</b>	<b>2.2</b>	<b>2.5</b>	<b>3</b>	<b>3</b>	<b>4.5</b>	<b>6</b>	<b>7</b>	<b>7</b>	<b>9</b>	<b>10</b>	<b>12</b>	<b>20</b>	<b>26</b>	<b>28</b>	<b>33</b>	<b>33</b>	
440 V	2.4	3.3	3.3	2.4	3	3.6	3.6	5.5	7	8	8	10	12	14	25	32	35	41	41	
500 V	2.2	3	3	2.5	2.8	3.5	3.5	6	8	9	9	11	13	16	29	36	40	47	47	
660 V/690 V	2.2	3	3	2.9	3.6	4.4	4.4	6.5	8.5	10	10	12	14	17	26	35	43	48	48	
1000 V	-	-	-	-	-	-	-	-	-	-	-	-	-	-	-	-	-	-	-	
<b>AC-1</b> Rated operational power under resistive load, 40 °C																				
220 V – 230 V	8	8	8	8	8	8	8	15	17	17	17	22	30	37	42	49	61	72	85	
<b>380 V – 400 V</b>	<b>13</b>	<b>13</b>	<b>13</b>	<b>14</b>	<b>14</b>	<b>14</b>	<b>14</b>	<b>26</b>	<b>29</b>	<b>29</b>	<b>29</b>	<b>39</b>	<b>53</b>	<b>65</b>	<b>72</b>	<b>85</b>	<b>105</b>	<b>125</b>	<b>150</b>	
440 V	15	15	15	16	16	16	16	30	34	34	34	45	58	71	80	94	116	138	170	
500 V	18	18	18	19	19	19	19	34	38	38	38	51	66	81	90	107	132	156	194	
660 V/690 V	23	23	23	25	25	25	25	45	51	51	51	68	91	111	125	148	182	216	268	
1000 V	-	-	-	-	-	-	-	-	-	-	-	-	-	-	-	-	-	-	-	
Conventional thermal Current $I_{th} = I_e$ open at 40 °C	A	A	A	A	A	A	A	A	A	A	A	A	A	A	A	A	A	A	A	A
	22	22	22	22	22	22	22	40	45	45	45	60	80	98	110	130	160	190	225	

Contactors  
4 pole

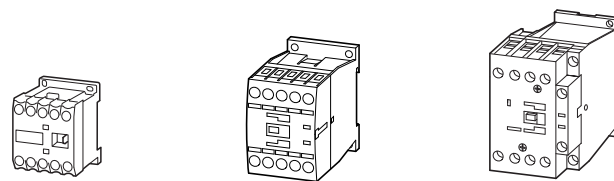

	<b>DIL</b>	<b>EM4</b>	<b>MP20</b>	<b>MP32</b>
Rated operational voltage	Page	→ 5/4	→ Page 5/36	→ Page 5/36
<b>AC-1</b> Conventional free air thermal current $I_{th} = I_e$ open, at 40 °C up to 690 V		A 22	A 22	A 32

**DILM, DILH, DILMP**

**Contactors**  
3 pole

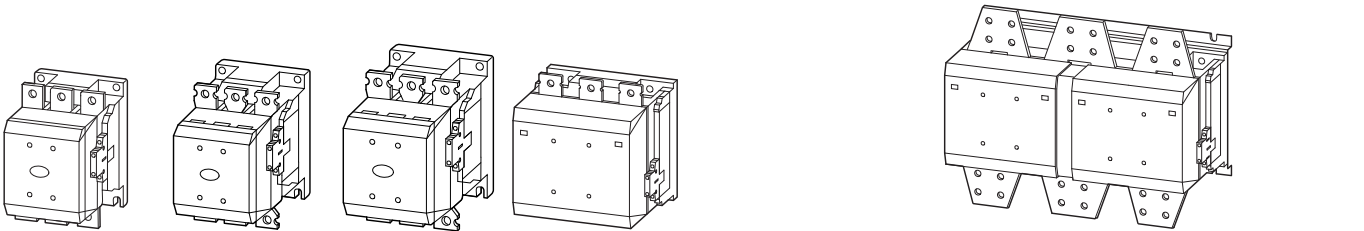

**M185A M225A M250 M300A M400 M500 M580 M650 M750 M820 M1000 M1600 H1400 H2000 H2200 H2600**

→ Page 5/32                      → Page 5/32                      → Page 5/32                      → Page 5/32                      → Page 5/34

kW    kW    kW    kW    kW    kW    kW    kW    kW    kW    kW    kW    kW    kW    kW    kW

55	70	75	90	125	155	185	205	240	260	315	500	-	-	-	-
<b>90</b>	<b>110</b>	<b>132</b>	<b>160</b>	<b>200</b>	<b>250</b>	<b>315</b>	<b>355</b>	<b>400</b>	<b>450</b>	<b>560</b>	<b>900</b>	-	-	-	-
115	142	157	190	255	345	370	420	480	525	650	1000	-	-	-	-
132	160	180	215	290	360	420	470	550	600	730	1180	-	-	-	-
175	215	240	286	344	344	560	630	720	750	1000	1600	-	-	-	-
108	108	108	132	132	132	600	600	800	800	1000	1770	-	-	-	-

41	51	62	75	92	112	143	161	181	209	260	430	-	-	-	-
<b>75</b>	<b>90</b>	<b>110</b>	<b>132</b>	<b>160</b>	<b>200</b>	<b>250</b>	<b>280</b>	<b>315</b>	<b>355</b>	<b>450</b>	<b>750</b>	-	-	-	-
85	102	125	140	186	229	290	326	367	418	520	830	-	-	-	-
96	116	143	172	214	260	330	370	417	474	590	940	-	-	-	-
127	155	189	229	283	344	440	494	556	633	780	1300	-	-	-	-
108	108	108	132	132	132	509	509	678	678	1000	1650	-	-	-	-

121	139	155	177	221	310	354	376	398	443	443	717	620	886	1075	1269
<b>210</b>	<b>241</b>	<b>268</b>	<b>306</b>	<b>382</b>	<b>535</b>	<b>612</b>	<b>650</b>	<b>689</b>	<b>766</b>	<b>766</b>	<b>1247</b>	<b>1071</b>	<b>1531</b>	<b>1870</b>	<b>2207</b>
243	279	310	354	443	620	709	753	797	886	886	1371	1240	1773	2058	2427
277	317	352	403	503	705	806	856	906	1007	1007	1558	1410	2015	2338	2758
365	419	465	532	664	930	1064	1130	1196	1330	1330	2151	1861	2660	3227	3806
554	635	705	806	1007	1410	1612	1712	1813	2015	2015	2420	2417	3223	4676	5516

A    A    A    A    A    A    A    A    A    A    A    A    A    A    A

337    356    400    430    612    857    980    1041    1102    1225    1225    2200    1714    2450    2700    3185

**Contactors**  
4 pole

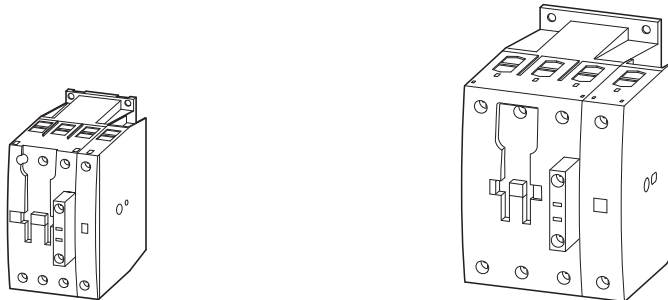

**MP45                      MP63                      MP80                      MP125                      MP160                      MP200**

→ Page 5/36                      → Page 5/36                                           → Page 5/36

A                      A                      A                      A                      A                      A

45                      63                      80                      125                      160                      200

DILM7...DILM170

System overview

Contactors up to 90 kW (AC-3/400 V) 1

3 pole  
→ Page 5/18

4 pole  
→ Page 5/36

Suppressor circuits 2  
→ Page 5/54

Overload relays 3  
→ Page 6/8

Auxiliary contact modules 4  
→ Page 5/38

Auxiliary contact modules 5  
→ Page 5/38

Auxiliary contact modules 6  
→ Page 5/41

Motor feeder plug 7  
→ Page 5/62

PE module with contact plate 8  
→ Page 5/62

Motor suppressor module  
→ Page 5/63

SmartWire-Darwin contactor module 10  
→ Page 5/62

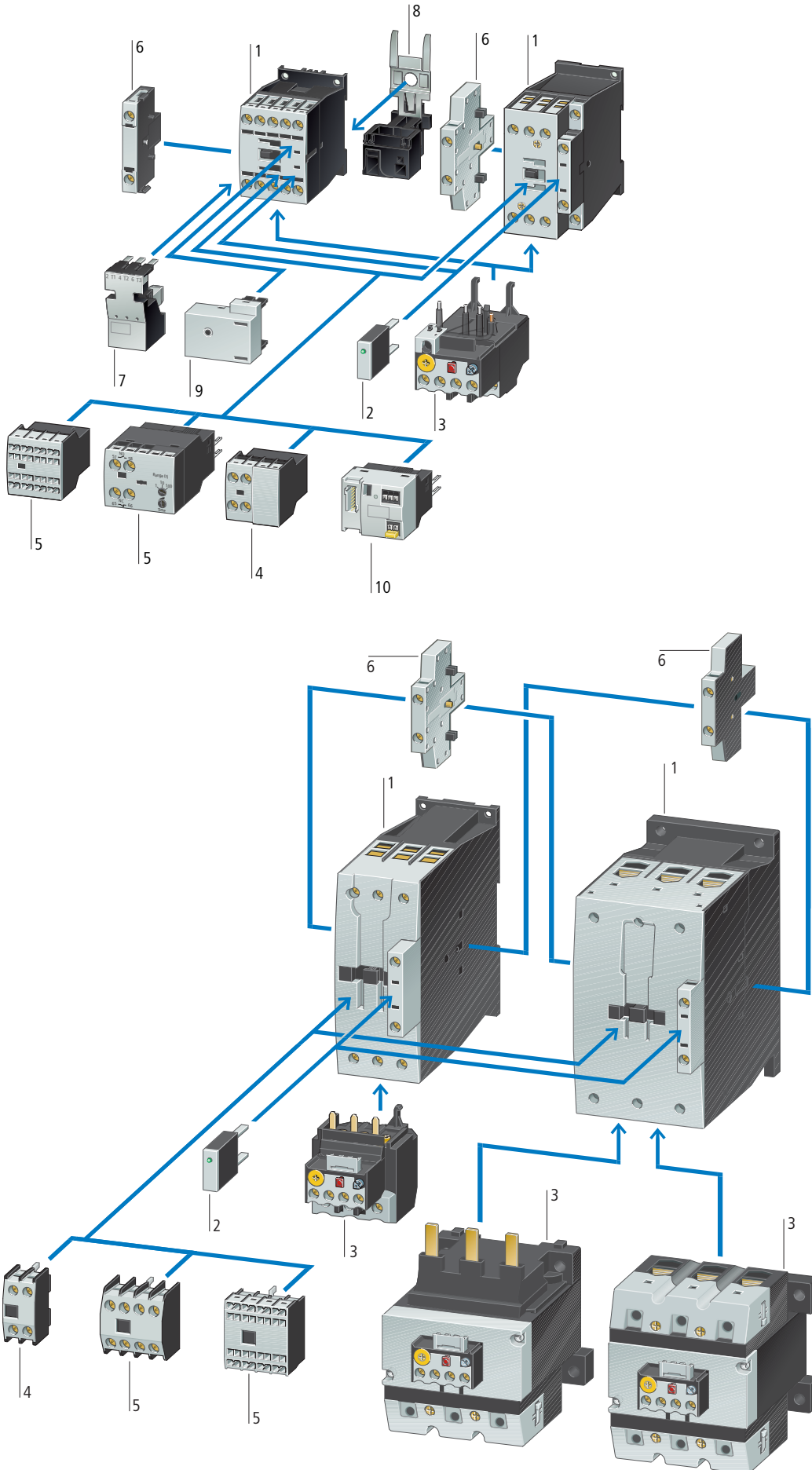

DILM185... DILH2600

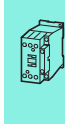
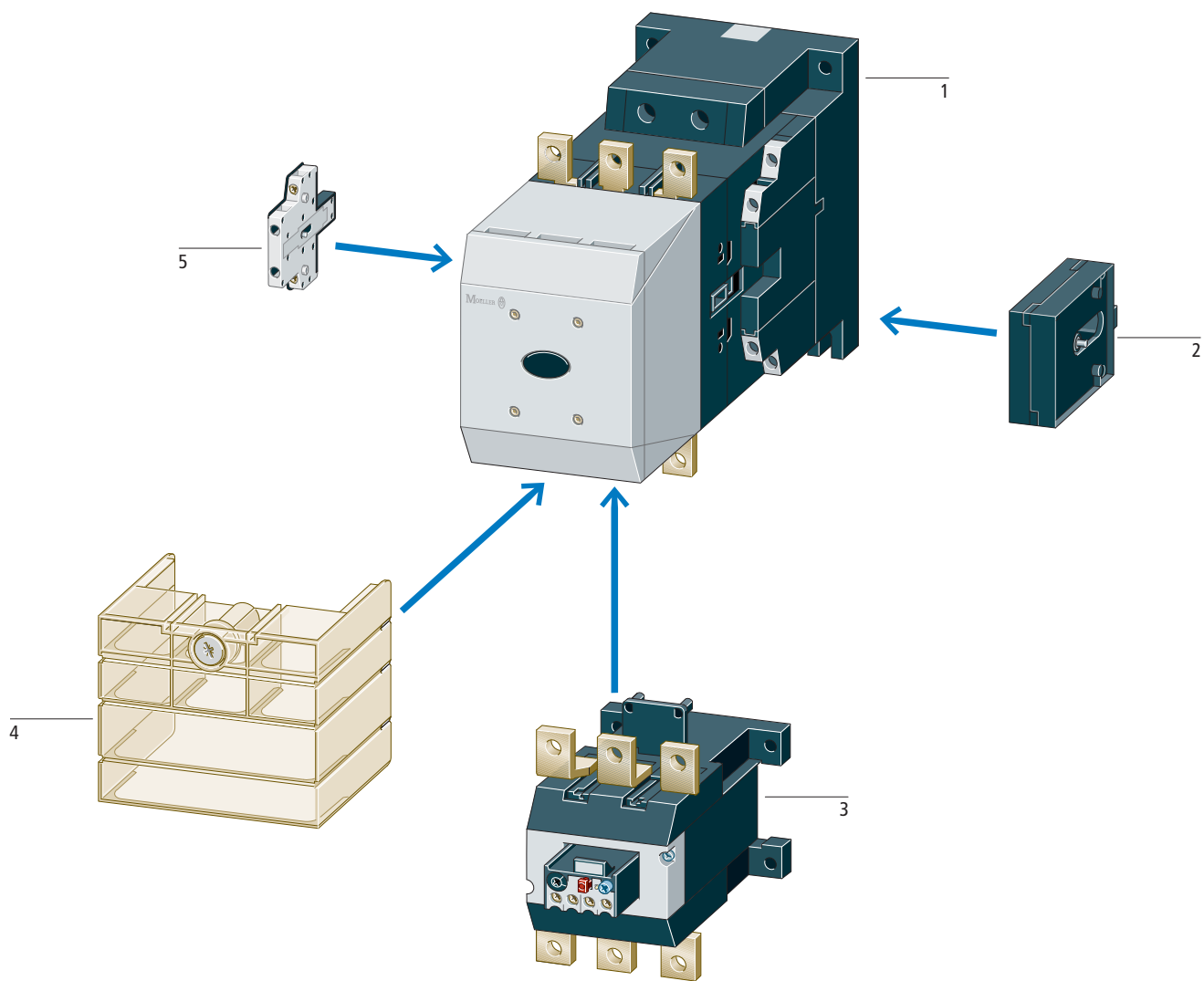

<b>Contactors 90 – 900 kW (AC-3/400 V) Comfort series</b>	1	<b>Mechanical interlock</b>	2	<b>Terminal shroud</b>	4
→ Page 5/32		→ Page 5/56		→ Page 5/65	
<b>Standard range 90 – 250 kW</b>	1	<b>Overload relays</b>	3	<b>Auxiliary contact modules</b>	5
→ Page 5/30		→ Page 6/12		→ Page 5/41	

Rated operational current	Max. motor rating for three-phase motors 50 - 60 Hz			Conventional thermal current $I_{th} = I_e$ AC-1 at 60 °C	Contact configuration	Circuit symbol			
	AC-3	AC-3	AC-4						
380 V 400 V	220 V 230 V	380 V 400 V	660 V 690 V	220 V 230 V	380 V 400 V	660 V 690 V	Open	N/O = normally open contact NC = normally closed contact	
$I_e$ A	P kW	P kW	P kW	P kW	P kW	P kW	$I_{th} = I_e$ A		

Basic device

Screw terminals

3 pole

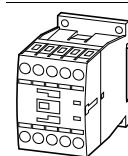

7	2.2	3	3.5	1	2.2	2.9	20	1 N/O	-	
7	2.2	3	3.5	1	2.2	2.9	20	-	1 NC	
9	2.5	4	4.5	1.5	2.5	3.6	20	1 N/O	-	
9	2.5	4	4.5	1.5	2.5	3.6	20	-	1 NC	
12	3.5	5.5	6.5	2	3	4.4	20	1 N/O	-	
12	3.5	5.5	6.5	2	3	4.4	20	-	1 NC	
15.5	4	7.5	7	2	3	4.4	20	1 N/O	-	
15.5	4	7.5	7	2	3	4.4	20	-	1 NC	
18	5	7.5	11	2.5	4.5	6.5	35	1 N/O	-	
18	5	7.5	11	2.5	4.5	6.5	35	-	1 NC	
25	7.5	11	14	3.5	6	8.5	40	1 N/O	-	
25	7.5	11	14	3.5	6	8.5	40	-	1 NC	
32	10	15	17	4	7	10	40	1 N/O	-	
32	10	15	17	4	7	10	40	-	1 NC	
38	11	18.5	21	4	7	10	40	1 N/O	-	
38	11	18.5	21	4	7	10	40	-	1 NC	

Information relevant for export to North America



Product Standards	IEC/EN 60947-4-1; UL 508; CSA-C22.2 No. 14-05; CE marking
UL File No.	E29096
UL CCN	NLDX
CSA File No.	012528
CSA Class No.	2411-03, 3211-04
NA Certification	UL Listed, CSA certified
See also	→ Page 5/84

Can be combined with auxiliary contact	AC operation	Price See price list	DC operation	Price See price list	Std. pack	Notes
	Part no. Article no.		Part no. Article no.			
	DILM7-10(230V50HZ) 276550		DILM7-10(24VDC) 276565			
	DILM7-01(230V50HZ) 276585		DILM7-01(24VDC) 276600			
	DILM9-10(230V50HZ) 276690		DILM9-10(24VDC) 276705			
	DILM9-01(230V50HZ) 276725		DILM9-01(24VDC) 276740			
	DILM12-10(230V50HZ) 276830		DILM12-10(24VDC) 276845			
	DILM12-01(230V50HZ) 276865		DILM12-01(24VDC) 276880			
	DILM15-10(230V50HZ) <sup>1)</sup> 290058		DILM15-10(24VDC) <sup>1)</sup> 290073			
	DILM15-01(230V50HZ) <sup>1)</sup> 290093		DILM15-01(24VDC) <sup>1)</sup> 290108			
	DILM17-10(230V50HZ) 277004		DILM17-10(RDC24) 277018			
	DILM17-01(230V50HZ) 277036		DILM17-01(RDC24) 277050			
	DILM25-10(230V50HZ) 277132		DILM25-10(RDC24) 277146			
	DILM25-01(230V50HZ) 277164		DILM25-01(RDC24) 277178			
	DILM32-10(230V50HZ) 277260		DILM32-10(RDC24) 277274			
	DILM32-01(230V50HZ) 277292		DILM32-01(RDC24) 277306			
	DILM38-10(230V50HZ) <sup>1)</sup> 112428		DILM38-10(RDC24) <sup>1)</sup> 112442			
	DILM38-01(230V50HZ) <sup>1)</sup> 112456		DILM38-01(RDC24) <sup>1)</sup> 112470			

1 off

Contacts to EN 50 012.  
For all DC operated contactors DILM7 - DILM15 the following applies:  
• Integrated varistor-suppressor circuit.  
For DC operated contactors DILM17 - DILM170 the following applies:  
• Integrated suppressor circuit in actuating electronics  
For AC operated contactors DILM115 - DILM170 the following applies:  
• Integrated suppressor circuit in actuating electronics  
For DILM7-01 – DILM38-01 the following applies:  
• With mirror contact.

<sup>1)</sup> Electrical lifespan → 5/91

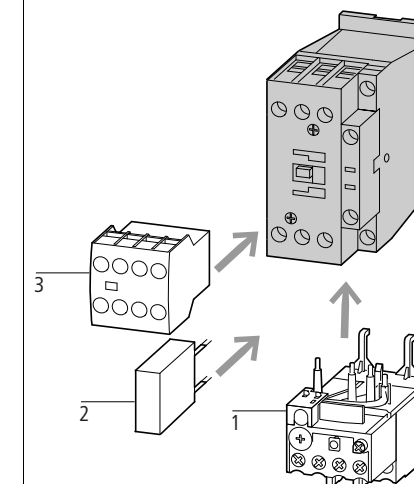

Accessories

- 1 Overload relay
- 2 Suppressor
- 3 Auxiliary contact module
- Further actuating voltages
- Accessories

Page

- Chapter 6
- 5/54
- 5/38
- 5/73
- 5/56

Rated operational current	Max. motor rating for three-phase motors 50 - 60 Hz						Conventional thermal current $I_{th} = I_e$ AC-1 at 60 °C	Contact configuration	Circuit symbol
	AC-3		AC-3		AC-4				
<b>380 V</b>	220 V	<b>380 V</b>	660 V	220 V	<b>380 V</b>	660 V	Open	N/O = normally open contact NC = normally closed contact	
<b>400 V</b>	230 V	<b>400 V</b>	690 V	230 V	<b>400 V</b>	690 V			
$I_e$	P	P	P	P	P	P	$I_{th} = I_e$		
A	kW	kW	kW	kW	kW	kW	A		

Basic device

Screw terminals

3 pole

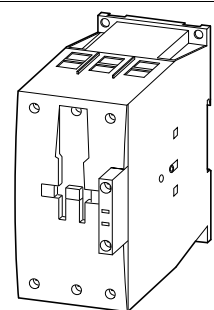
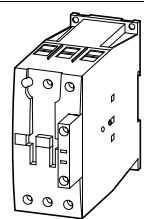

<b>40</b>	12.5	<b>18.5</b>	23	5	<b>9</b>	12	50	-	-	
<b>50</b>	15.5	<b>22</b>	30	6	<b>10</b>	14	65	-	-	
<b>65</b>	20	<b>30</b>	35	7	<b>12</b>	17	80	-	-	
<b>72</b>	25	<b>37</b>	35	7	<b>12</b>	17	80	-	-	
<b>80</b>	25	<b>37</b>	63	12	<b>20</b>	26	90	-	-	
<b>95</b>	30	<b>45</b>	75	16	<b>26</b>	35	110	-	-	
<b>115</b>	37	<b>55</b>	90	17	<b>28</b>	43	130	-	-	
<b>150</b>	48	<b>75</b>	96	20	<b>33</b>	48	160	-	-	
<b>170</b>	52	<b>90</b>	140	20	<b>33</b>	48	185	-	-	

Information relevant for export to North America



Product Standards IEC/EN 60947-4-1; UL 508; CSA-C22.2 No. 14-05; CE marking  
 UL File No. E29096  
 UL CCN NLDX  
 CSA File No. 012528  
 CSA Class No. 2411-03, 3211-04  
 NA Certification UL Listed, CSA certified  
 See also → Page 5/84

Can be combined with auxiliary contact	AC operation	Price See price list	DC operation	Price See price list	Std. pack	Notes
	Part no. Article no.		Part no. Article no.			
	<b>DILM40(230V50HZ)</b> 277766		<b>DILM40(RDC24)</b> 277780			1 off Contacts to EN 50012. For all DC operated contactors DILM7 - DILM15 the following applies: • Integrated varistor-suppressor circuit. For DC operated contactors DILM17 - DILM170 the following applies: • Integrated suppressor circuit in actuating electronics For AC operated contactors DILM115 - DILM170 the following applies: • Integrated suppressor circuit in actuating electronics For DILM7-01 - DILM38-01 the following applies: • With mirror contact. <sup>1)</sup> Electrical lifespan → 5/91
	<b>DILM50(230V50HZ)</b> 277830		<b>DILM50(RDC24)</b> 277844			
	<b>DILM65(230V50HZ)</b> 277894		<b>DILM65(RDC24)</b> 277908			
	<b>DILM72(230V50HZ)<sup>1)</sup></b> 107670		<b>DILM72(RDC24)<sup>1)</sup></b> 107671			
	<b>DILM80(230V50HZ)</b> 239402		<b>DILM80(RDC24)</b> 239416			
	<b>DILM95(230V50HZ)</b> 239480		<b>DILM95(RDC24)</b> 239510			
	<b>DILM115(RAC240)</b> 239548		<b>DILM115(RDC24)</b> 239555			
	<b>DILM150(RAC240)</b> 239588		<b>DILM150(RDC24)</b> 239591			
	<b>DILM170(RAC240)<sup>1)</sup></b> 107013		<b>DILM170(RDC24)<sup>1)</sup></b> 107016			
	<b>DILM150-XHI(V)..</b> DILM1000-XHI(V)..					

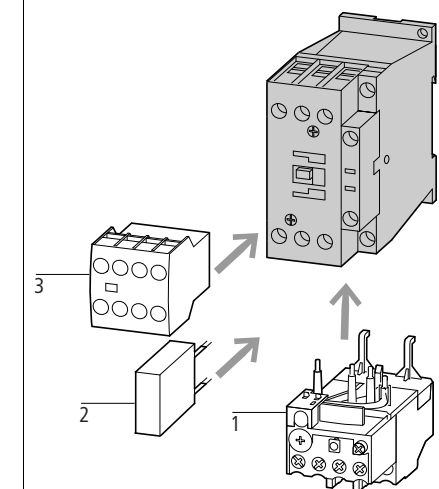







**Accessories**  
 1 Overload relay  
 2 Suppressor  
 3 Auxiliary contact module  
 Further actuating voltages  
 Accessories

**Page**  
 → Chapter 6  
 → 5/54  
 → 5/38  
 → 5/75  
 → 5/56

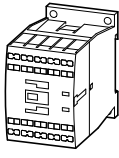
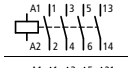
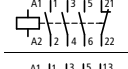

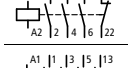



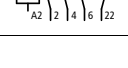



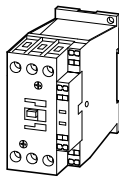

Rated operational current AC-3	Max. motor rating for three-phase motors 50 - 60 Hz			Conventional thermal current $I_{th} = I_e$ AC-1 at 60 °C	Contact configuration N/O = normally open contact NC = normally closed contact	Circuit symbol
	AC-3	AC-3	AC-4			
<b>380 V</b> <b>400 V</b>	220 V 230 V	<b>380 V</b> <b>400 V</b>	660 V 690 V	220 V 230 V	<b>380 V</b> <b>400 V</b>	660 V 690 V
$I_e$	P	P	P	P	P	P
A	kW	kW	kW	kW	kW	kW

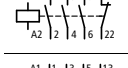

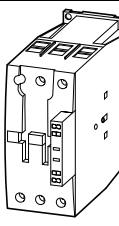
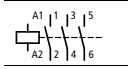
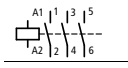

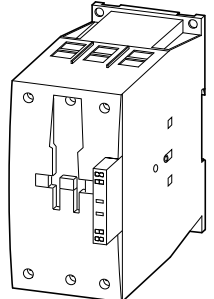
Basic device

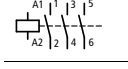
Spring-loaded terminals  
3 pole

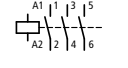
	7	2.2	3	3.5	1	2.2	2.9	20	1 N/O	-	
	7	2.2	3	3.5	1	2.2	2.9	20	-	1 NC	
	9	2.5	4	4.5	1.5	2.5	3.6	20	1 N/O	-	
	9	2.5	4	4.5	1.5	2.5	3.6	20	-	1 NC	
	12	3.5	5.5	6.5	2	3	4.4	20	1 N/O	-	
	12	3.5	5.5	6.5	2	3	4.4	20	-	1 NC	
	15.5	4	7.5	7	2	3	4.4	20	1 N/O	-	
	15.5	4	7.5	7	2	3	4.4	20	-	1 NC	

Spring-loaded terminals on auxiliary and control circuit terminals  
3 pole

	18	5	7.5	11	2.5	4.5	6.5	35	1 N/O	-	
	18	5	7.5	11	2.5	4.5	6.5	35	-	1 NC	
	25	7.5	11	14	3.5	6	8.5	40	1 N/O	-	
	25	7.5	11	14	3.5	6	8.5	40	-	1 NC	
	32	10	15	17	4	7	10	40	1 N/O	-	
	32	10	15	17	4	7	10	40	-	1 NC	
	40	12.5	18.5	23	5	9	12	50	-	-	
	50	15.5	22	30	6	10	14	65	-	-	
	65	20	30	35	7	12	17	80	-	-	
	80	25	37	63	12	20	26	90	-	-	
	95	30	45	75	16	26	35	110	-	-	
	115	37	55	90	17	28	43	130	-	-	
	150	48	75	96	20	33	48	160	-	-	

Can be combined with auxiliary contact	AC operation		DC operation		Std. pack	Notes
	Part no. Article no.	Price See price list	Part no. Article no.	Price See price list		
	DILM32-XHIC.. DILA-XHIC(V)..	<b>DILMC7-10(230V50HZ)</b> 277389		<b>DILMC7-10(24VDC)</b> 277404	1 off 	Contacts to EN 50 012. For DILMC7 – DILMC15 the following applies: • Auxiliary coil, and main current terminals with spring-loaded terminals. For DILMC17 – DILMC150 the following applies: • Auxiliary connections, coil connections with spring-loaded connection terminals. • Main current connections with screw terminals. For DC operated contactors DILMC7 - DILMC15 the following applies: • Integrated varistor-suppressor circuit. For DC operated contactors DILMC17 - DILMC150 the following applies: • Integrated suppressor circuit in actuating electronics For AC operated contactors DILMC115 - DILMC150 the following applies: • Integrated suppressor circuit in actuating electronics For DILMC7-01 – DILMC32-01 the following applies: • With mirror contact.
	DILA-XHIC(V)..	<b>DILMC7-01(230V50HZ)</b> 277421		<b>DILMC7-01(24VDC)</b> 277436		
	DILM32-XHIC.. DILA-XHIC(V)..	<b>DILMC9-10(230V50HZ)</b> 277453		<b>DILMC9-10(24VDC)</b> 277468	1 off 	
	DILA-XHIC(V)..	<b>DILMC9-01(230V50HZ)</b> 277485		<b>DILMC9-01(24VDC)</b> 277500		
	DILM32-XHIC.. DILA-XHIC(V)..	<b>DILMC12-10(230V50HZ)</b> 277517		<b>DILMC12-10(24VDC)</b> 277532	1 off 	
	DILA-XHIC(V)..	<b>DILMC12-01(230V50HZ)</b> 277549		<b>DILMC12-01(24VDC)</b> 277564		
	DILM32-XHIC... DILA-XHIC(V)...	<b>DILMC15-10(230V50HZ)</b> 293911		<b>DILMC15-10(24VDC)</b> 293926	1 off 	
	DILA-XHIC(V)...	<b>DILMC15-01(230V50HZ)</b> 293946		<b>DILMC15-01(24VDC)</b> 293961		
	DILM32-XHIC.. DILA-XHIC(V)..	<b>DILMC17-10(230V50HZ)</b> 277581		<b>DILMC17-10(RDC24)</b> 277595	1 off 	
	DILA-XHIC(V)..	<b>DILMC17-01(230V50HZ)</b> 277611		<b>DILMC17-01(RDC24)</b> 277625		
	DILM32-XHIC.. DILA-XHIC(V)..	<b>DILMC25-10(230V50HZ)</b> 277641		<b>DILMC25-10(RDC24)</b> 277655	1 off 	
	DILA-XHIC(V)..	<b>DILMC25-01(230V50HZ)</b> 277671		<b>DILMC25-01(RDC24)</b> 277685		
	DILM32-XHIC.. DILA-XHIC(V)..	<b>DILMC32-10(230V50HZ)</b> 277701		<b>DILMC32-10(RDC24)</b> 277715	1 off 	
	DILA-XHIC(V)..	<b>DILMC32-01(230V50HZ)</b> 277731		<b>DILMC32-01(RDC24)</b> 277745		
	DILM150-XHIC(V).. DILM1000-XHIC..	<b>DILMC40(230V50HZ)</b> 277965		<b>DILMC40(RDC24)</b> 277979	1 off 	
		<b>DILMC50(230V50HZ)</b> 277995		<b>DILMC50(RDC24)</b> 278009		
		<b>DILMC65(230V50HZ)</b> 278025		<b>DILMC65(RDC24)</b> 278039		
		<b>DILMC80(230V50HZ)</b> 239618		<b>DILMC80(RDC24)</b> 239652	1 off 	
		<b>DILMC95(230V50HZ)</b> 239685		<b>DILMC95(RDC24)</b> 239715		
		<b>DILMC115(RAC240)</b> 239736		<b>DILMC115(RDC24)</b> 239741		
		<b>DILMC150(RAC240)</b> 239751		<b>DILMC150(RDC24)</b> 239765	1 off 	

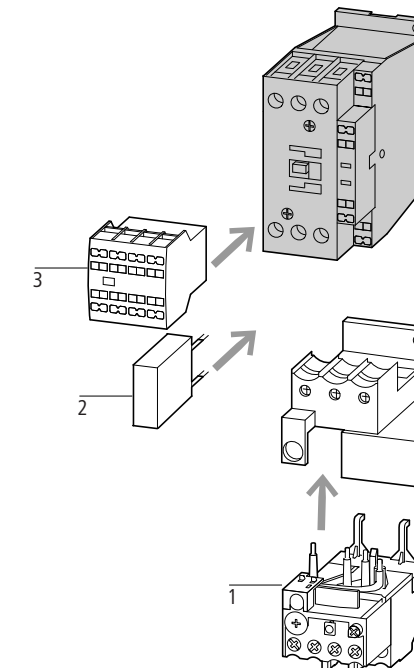

Accessories	Page
1 Overload relay	→ Chapter 6
2 Suppressor	→ 5/54
3 Auxiliary contact module	→ 5/38
Further actuating voltages	→ 5/77
Accessories	→ 5/56

Information relevant for export to North America

Product Standards	IEC/EN 60947-4-1; UL 5080; CSA-C22.2 No. 14-05; CE marking
UL File No.	E29096
UL CCN	NLDX
CSA File No.	012528
CSA Class No.	2411-03, 3211-04
NA Certification	UL Listed, CSA certified
See also	→ Page 5/84



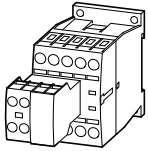
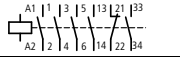
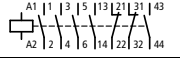
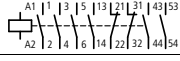
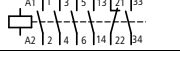
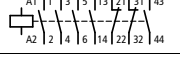
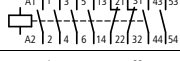
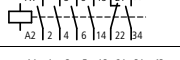
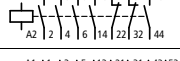
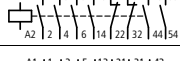
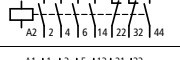
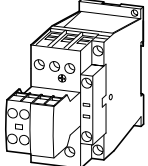
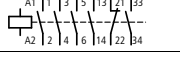
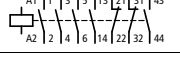
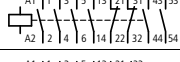
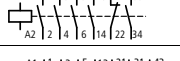
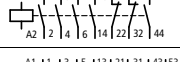
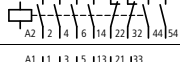
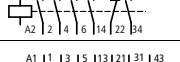
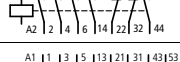
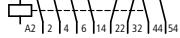

Rated operational current AC-3	Max. motor rating for three-phase motors 50 - 60 Hz						Conventional free air thermal current $I_{th} = I_e$ AC-1 at 60 °C	Contact configuration: ⊕ = Safety function by positive opening according to IEC/EN 60947-5-1	Circuit symbol
	AC-3	AC-3		AC-4		AC-4			
<b>380 V</b> <b>400 V</b>	220 V	<b>380 V</b>	660 V	220 V	<b>380 V</b>	660 V	Open $I_{th} = I_e$	N/O = normally open contact NC = normally closed contact	
	230 V	<b>400 V</b>	690 V	230 V	<b>400 V</b>	690 V			
<b>I<sub>e</sub></b>	P	<b>P</b>	P	P	<b>P</b>	P			
<b>A</b>	kW	<b>kW</b>	kW	kW	<b>kW</b>	kW			

DILM complete device

Screw terminals											
	7	2.2	3	3.5	1	2.2	2.9	20	2 N/O	1 NC	
	7	2.2	3	3.5	1	2.2	2.9	20	2 N/O	1 NC	
	7	2.2	3	3.5	1	2.2	2.9	20	3 N/O	2 NC	
	9	2.5	4	4.5	1.5	2.5	3.6	20	2 N/O	1 NC	
	9	2.5	4	4.5	1.5	2.5	3.6	20	2 N/O	1 NC	
	9	2.5	4	4.5	1.5	2.5	3.6	20	3 N/O	2 NC	
	12	3.5	5.5	6.5	2	3	4.4	20	2 N/O	1 NC	
	12	3.5	5.5	6.5	2	3	4.4	20	2 N/O	1 NC	
	12	3.5	5.5	6.5	2	3	4.4	20	3 N/O	2 NC	
	15.5	4	7.5	7	2	3	4.4	20	2 N/O	2 NC	
	18	5	7.5	11	2.5	4.5	6.5	35	2 N/O	1 NC	
	18	5	7.5	11	2.5	4.5	6.5	35	2 N/O	1 NC	
	18	5	7.5	11	2.5	4.5	6.5	35	3 N/O	2 NC	
	25	7.5	11	14	3.5	6	8.5	40	2 N/O	1 NC	
	25	7.5	11	14	3.5	6	8.5	40	2 N/O	1 NC	
	25	7.5	11	14	3.5	6	8.5	40	3 N/O	2 NC	
	32	10	15	17	4	7	10	40	2 N/O	1 NC	
	32	10	15	17	4	7	10	40	2 N/O	1 NC	
	32	10	15	17	4	7	10	40	3 N/O	2 NC	

Information relevant for export to North America

	Product Standards	IEC/EN 60947-4-1; UL 508; CSA-C22.2 No. 14-05;
	CE marking	E29096
	UL File No.	NLDX
	UL CCN	012528
	CSA File No.	2411-03, 3211-04
	CSA Class No.	UL Listed, CSA certified
	NA Certification	→ Page 5/84
	See also	

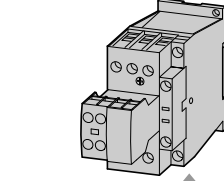
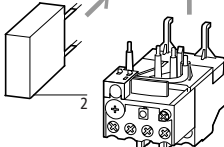





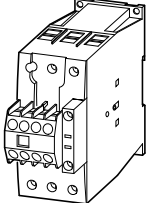

AC operation Part no. Article no.	Price See price list	DC operation Part no. Article no.	Price See price list	Std. pack	Notes
<b>DILM7-21(230V50HZ)</b> 276620		<b>DILM7-21(24VDC)</b> 276635		1 off 	
<b>DILM7-22(230V50HZ)</b> 106360		<b>DILM7-22(24VDC)</b> 106367			
<b>DILM7-32(230V50HZ)</b> 276655		<b>DILM7-32(24VDC)</b> 276670			
<b>DILM9-21(230V50HZ)</b> 276760		<b>DILM9-21(24VDC)</b> 276775			
<b>DILM9-22(230V50HZ)</b> 106361		<b>DILM9-22(24VDC)</b> 106368			
<b>DILM9-32(230V50HZ)</b> 276795		<b>DILM9-32(24VDC)</b> 276810			
<b>DILM12-21(230V50HZ)</b> 276900		<b>DILM12-21(24VDC)</b> 276915			
<b>DILM12-22(230V50HZ)</b> 106362		<b>DILM12-22(24VDC)</b> 106369			
<b>DILM12-32(230V50HZ)</b> 276935		<b>DILM12-32(24VDC)</b> 276950			
<b>DILM15-22(230V50HZ)</b> 106363		<b>DILM15-22(24VDC)</b> 106370			
<b>DILM17-21(230V50HZ)</b> 277068		<b>DILM17-21(RDC24)</b> 277082			
<b>DILM17-22(230V50HZ)</b> 106364		<b>DILM17-22(RDC24)</b> 106371			
<b>DILM17-32(230V50HZ)</b> 277100		<b>DILM17-32(RDC24)</b> 277114			
<b>DILM25-21(230V50HZ)</b> 277196		<b>DILM25-21(RDC24)</b> 277210			
<b>DILM25-22(230V50HZ)</b> 106365		<b>DILM25-22(RDC24)</b> 106372			
<b>DILM25-32(230V50HZ)</b> 277228		<b>DILM25-32(RDC24)</b> 277242			
<b>DILM32-21(230V50HZ)</b> 277324		<b>DILM32-21(RDC24)</b> 277338			
<b>DILM32-22(230V50HZ)</b> 106366		<b>DILM32-22(RDC24)</b> 106373			
<b>DILM32-32(230V50HZ)</b> 277356		<b>DILM32-32(RDC24)</b> 277370			

Accessories	Page
1 Overload relay	→ Chapter 6
2 Suppressor	→ 5/54
Accessories	→ 5/56

For all DC operated contactors DILM7 - DILM15 the following applies:  
 • Integrated varistor suppressor circuit.  
 For DC operated contactors DILM17 - DILM170 the following applies:  
 • Integrated suppressor circuit in actuating electronics  
 For AC operated contactors DILM115 - DILM170 the following applies:  
 • Integrated suppressor circuit in actuating electronics  
 For DILM7 - DILM150 the following applies:  
 • With mirror contact.  
 Contacts to EN 50012

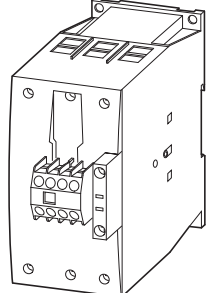
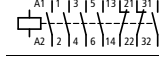
Rated operational current AC-3	Max. motor rating for three-phase motors 50 - 60 Hz						Conventional free air thermal current $I_{th} = I_e$ AC-1 at 60 °C	Contact configuration: ⊕ = Safety function by positive opening according to IEC/EN 60947-5-1	Circuit symbol
	AC-3		AC-4						
<b>380 V</b> <b>400 V</b>	220 V 230 V	<b>380 V</b> <b>400 V</b>	660 V 690 V	220 V 230 V	<b>380 V</b> <b>400 V</b>	660 V 690 V	Open $I_{th} = I_e$	N/O = normally open contact NC = normally closed contact	
$I_e$	P	<b>P</b>	P	P	<b>P</b>	P			
<b>A</b>	kW	<b>kW</b>	kW	kW	<b>kW</b>	kW	A		

**DILM complete device**

Screw terminals											
	<b>40</b>	12.5	<b>18.5</b>	23	5	<b>9</b>	12	50	2 N/O	2 NC	
	<b>50</b>	15.5	<b>22</b>	30	6	<b>10</b>	14	65	2 N/O	2 NC	
	<b>65</b>	20	<b>30</b>	35	7	<b>12</b>	17	80	2 N/O	2 NC	
	<b>80</b>	25	<b>37</b>	63	12	<b>20</b>	26	90	2 N/O	2 NC	
	<b>95</b>	30	<b>45</b>	75	16	<b>26</b>	35	110	2 N/O	2 NC	
	<b>115</b>	37	<b>55</b>	90	17	<b>28</b>	43	130	2 N/O	2 NC	
	<b>150</b>	48	<b>75</b>	96	20	<b>34</b>	48	160	2 N/O	2 NC	

**Information relevant for export to North America**

	
Product Standards	IEC/EN 60947-4-1; UL 508; CSA-C22.2 No. 14-05; CE marking
UL File No.	E29096
UL CCN	NLDX
CSA File No.	012528
CSA Class No.	2411-03, 3211-04
NA Certification	UL Listed, CSA certified
See also	→ Page 5/84

AC operation Part no. Article no.	Price See price list	DC operation Part no. Article no.	Price See price list	Std. pack	Notes
<b>DILM40-22(230V50HZ)</b> 277798		<b>DILM40-22(RDC24)</b> 277812			
<b>DILM50-22(230V50HZ)</b> 277862		<b>DILM50-22(RDC24)</b> 277876			
<b>DILM65-22(230V50HZ)</b> 277926		<b>DILM65-22(RDC24)</b> 277940			
<b>DILM80-22(230V50HZ)</b> 239449		<b>DILM80-22(RDC24)</b> 239463			
<b>DILM95-22(230V50HZ)</b> 239527		<b>DILM95-22(RDC24)</b> 239541			
<b>DILM115-22(RAC240)</b> 239578		<b>DILM115-22(RDC24)</b> 239581			
<b>DILM150-22(RAC240)</b> 239598		<b>DILM150-22(RDC24)</b> 239601			

1 off



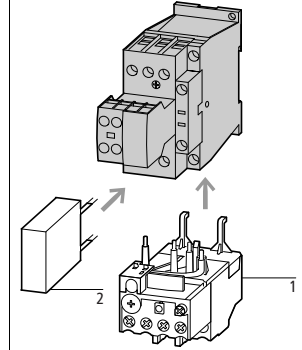

**Accessories**

- 1 Overload relay
- 2 Suppressor
- Accessories

**Page**

- Chapter 6
- 5/54
- 5/56

For DC operated contactors DILM17 - DILM170 the following applies:

- Integrated suppressor circuit in actuating electronics

For AC operated contactors DILM115 - DILM170 the following applies:

- Integrated suppressor circuit in actuating electronics

For DILM7 - DILM150 the following applies:







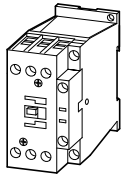

- With mirror contact.

Contacts to EN 50012

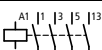
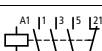
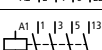
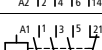
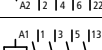
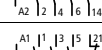
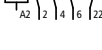
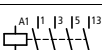
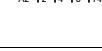
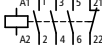
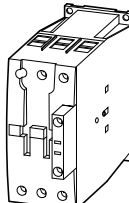
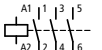
Pole	Rated operational current	Max. motor rating, three-phase motors, 50 - 60 Hz						Conventional thermal current $I_{th} = I_e$ AC-1 at 60 °C	Contact configuration: ⊕ = Safety function by positive opening according to IEC/EN 60947-5-1	Circuit symbol
		AC-3		AC-3		AC-4				
	<b>380 V</b> <b>400 V</b>	220 V	<b>380 V</b>	660 V	220 V	<b>380 V</b>	660 V	Open		
		230 V	<b>400 V</b>	690 V	230 V	<b>400 V</b>	690 V			
	$I_e$	P	<b>P</b>	P	P	<b>P</b>	P	$I_{th} = I_e$		
	<b>A</b>	kW	<b>kW</b>	kW	kW	<b>kW</b>	kW	A	N/O = normally open contact NC = normally closed contact	

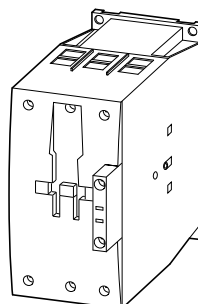
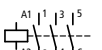
Basic device

Screw terminals

	3 pole	7	2.2	3	3.5	1	2.2	2.9	20	1 N/O	–	
		7	2.2	3	3.5	1	2.2	2.9	20	–	1 NC	
		9	2.5	4	4.5	1.5	2.5	3.6	20	1 N/O	–	
		9	2.5	4	4.5	1.5	2.5	3.6	20	–	1 NC	
		12	3.5	5.5	6.5	2	3	4.4	20	1 N/O	–	
		12	3.5	5.5	6.5	2	3	4.4	20	–	1 NC	
		18	5	7.5	11	2.5	4.5	6.5	35	1 N/O	–	
		18	5	7.5	11	2.5	4.5	6.5	35	–	1 NC	
		25	7.5	11	14	3.5	6	8.5	40	–	1 NC	
		25	7.5	11	14	3.5	6	8.5	40	1 N/O	–	
		32	10	15	17	4	7	10	40	1 N/O	–	
		32	10	15	17	4	7	10	40	–	1 NC	
	3 pole	40	12.5	18.5	23	5	9	12	50	–	–	
		50	15.5	22	30	6	10	14	65	–	–	
		65	20	30	35	7	12	17	80	–	–	
	3 pole	80	25	37	63	12	20	26	90	–	–	
		95	30	45	75	16	26	35	110	–	–	
		115	37	55	90	17	28	43	130	–	–	
		150	48	75	96	20	33	48	160	–	–	

2) Information relevant for export to North America

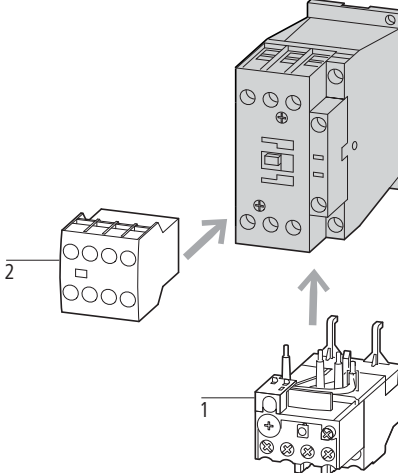

Product Standards	IEC/EN 60947-4-1; UL 508; CSA-C22.2 No. 14-05; CE marking
UL File No.	E29096
UL CCN	NLDX
CSA File No.	012528
CSA Class No.	2411-03, 3211-04
NA Certification	UL Listed, CSA certified
See also	→ Page 5/84

AC operation Part no. Article no.	Price See price list	Std. pack	Notes
<b>DILMF8-10(RAC240)</b> 104413		1 off 	<p>Contactors suitable for semi-conductor industry according to SEMI F47. Contactors hum-free, suitable for building services automation. Operating mechanism adjustable from 50 Hz to 400 Hz.</p> <p>For all contactors the following applies:                      • Integrated suppressor circuit                      For DILMF8-01 – DILMF32-01 the following applies:                      • With mirror contact.                      Contacts to EN 50 012.</p> <div style="text-align: center;">  </div> <p><b>Accessories</b></p> <p>1 Overload relay → Chapter 6</p> <p>2 Auxiliary contact modules → 5/38</p> <p>Further actuating voltages → 5/80</p> <p>Accessories → 5/56</p>
<b>DILMF8-01(RAC240)</b> 104417			
<b>DILMF11-10(RAC240)</b> 104421			
<b>DILMF11-01(RAC240)</b> 104425			
<b>DILMF14-10(RAC240)</b> 104429			
<b>DILMF14-01(RAC240)</b> 104433			
<b>DILMF17-10(RAC240)</b> 104437			
<b>DILMF17-01(RAC240)</b> 104441			
<b>DILMF25-01(RAC240)</b> 104449			
<b>DILMF25-10(RAC240)</b> 104445			
<b>DILMF32-10(RAC240)</b> 104453			
<b>DILMF32-01(RAC240)</b> 104457			
<b>DILMF40(RAC240)</b> 104461			
<b>DILMF50(RAC240)</b> 104465			
<b>DILMF65(RAC240)</b> 104469			
<b>DILMF80(RAC240)</b> 104473			
<b>DILMF95(RAC240)</b> 104477			
<b>DILMF115(RAC240)</b> 104481			
<b>DILMF150(RAC240)</b> 104485			

Rated operational current	Max. motor rating for three-phase motors 50 - 60 Hz						Conventional thermal current $I_{th} = I_e$ AC-1 at 40 °C Open	Circuit symbol	For use with
	AC-3		AC-3		AC-4				
<b>380 V</b>	220 V	<b>380 V</b>	660 V	220 V	<b>380 V</b>	660 V		A	
<b>400 V</b>	230 V	<b>400 V</b>	690 V	230 V	<b>400 V</b>	690 V			
$I_e$	P	<b>P</b>	P	P	<b>P</b>	P			
A	kW	<b>kW</b>	kW	kW	<b>kW</b>	kW			

Standard device for currents greater than 150 A

DILM complete device

	250	75	132	240	62	110	189	400		
										DILM820-XHI...
										DILM820-XHI...
										DILM820-XHI...
										DILM820-XHI...
										DILM820-XHI...

Notes

<sup>1)</sup> Availability from August 2010.  
Previous DILM300/22, see Online Catalog at <http://ecat.moeller.net>

For all contactors the following applies:

- 660 V, 690 V or 1000 V: do not reverse directly
- Integrated suppressor circuit in actuating electronics.

DILM...-S contactors are actuated conventionally

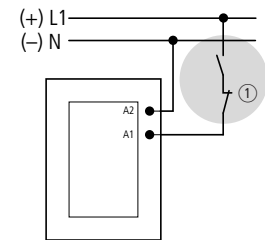

① Stopping in the event of an emergency (emergency switching off)

Accessories

Auxiliary contact modules	→ 5/40
Enclosures <span style="border: 1px solid black; padding: 2px;">totally insulated</span>	
Further actuating voltages	→ 5/81

Page

Part no. Article no.	Price See price list	Std. pack	Information relevant for export to North America	
<b>DILM250-S/22(220-240V50/60HZ)</b> 274190		1 off 	Product Standards UL File No. UL CCN CSA File No. CSA Class No. NA Certification	IEC/EN 60947-4-1; UL 508; CSA-C22.2 No. 14-05; CE marking E29096 NLDX 1017510 3211-04 UL Listed, CSA certified
<b>DILM300A-S/22(220-240V50/60HZ)<sup>1)</sup></b> 139559		1 off 	Request filed for UL and CSA	
<b>DILM400-S/22(220-240V50/60HZ)</b> 274196		1 off 	Product Standards UL File No. UL CCN CSA File No. CSA Class No. NA Certification See also	IEC/EN 60947-4-1; UL 508; CSA-C22.2 No. 14-05; CE marking E29096 NLDX 012528 3211-04 UL Listed, CSA certified Additional approvals, → Page 5/86
<b>DILM500-S/22(220-240V50/60HZ)</b> 274199				
<b>DILM570-S/22(220-240V50/60HZ)</b> 110744				

Rated operational current	Max. motor rating for three-phase motors 50 - 60 Hz									Conventional thermal current $I_{th} = I_e$ AC-1 at 60 °C Open $I_{th} = I_e$	Circuit symbol
	AC-3			AC-3			AC-4				
<b>380 V</b> <b>400 V</b>	220 V	<b>380 V</b>	660 V	1000 V	220 V	<b>380 V</b>	660 V	1000 V			
<b><math>I_e</math></b>	P	<b>P</b>	P	P	P	<b>P</b>	P	P	P	A	
<b>A</b>	kW	<b>kW</b>	kW	kW	kW	<b>kW</b>	kW	kW			

Contactors, comfort DILM

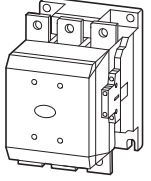
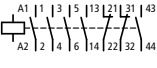
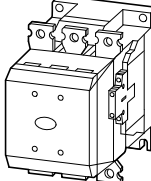
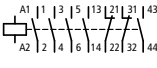
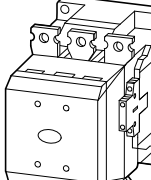
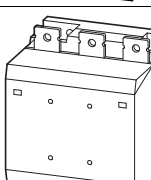
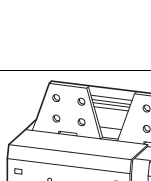
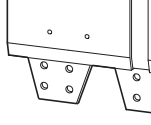
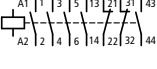
	<b>185</b>	55	<b>90</b>	140	108	41	<b>75</b>	102	77	275	
	<b>225</b>	70	<b>110</b>	150	108	51	<b>90</b>	110	77	315	
	<b>250</b>	75	<b>132</b>	195	108	62	<b>110</b>	160	109	330	
	<b>300</b>	90	<b>160</b>	195	132	75	<b>132</b>	160	109	350	
	<b>400</b>	125	<b>200</b>	344	132	92	<b>160</b>	283	132	500	
	<b>500</b>	155	<b>250</b>	344	132	112	<b>200</b>	344	132	700	
	<b>580</b>	185	<b>315</b>	560	600	143	<b>250</b>	440	509	800	
	<b>650</b>	205	<b>355</b>	630	600	161	<b>280</b>	494	509	850	
	<b>750</b>	240	<b>400</b>	720	800	181	<b>315</b>	556	678	900	
	<b>820</b>	260	<b>450</b>	750	800	209	<b>355</b>	633	678	1000	
	<b>1000</b>	315	<b>560</b>	1000	1100	260	<b>450</b>	780	1000	1000	
	<b>1600</b>	500	<b>900</b>	1600	1770	430	<b>750</b>	1300	1650	1800	

Notes

<sup>1)</sup> Availability from August 2010.  
Previous DILM185/22 to DILM300/22, see Online Catalog at <http://ecat.moeller.net>

For all contactors the following applies:

- 660 V, 690 V or 1000 V: do not reverse directly
- Integrated suppressor circuit in actuating electronics.

When operating contactors DILM580 to DILM1600 behind a frequency inverter or mains with strong harmonic loads, the suppressor circuit on the load side must be removed.

During high-voltage tests, the suppressor circuit on the load-side for DILM580 to DILH2600 contactors must be disconnected (see instructional leaflet).

Control voltages

RA250  $\triangleq$  110 V - 250 V AC/DC

RAW250  $\triangleq$  230 V - 250 V AC/DC

Accessories

Accessories	Page
Auxiliary contact modules	→ 5/40
Suppressor circuits on load side	→ 5/65
Enclosures 	
Further actuating voltages	→ 5/76

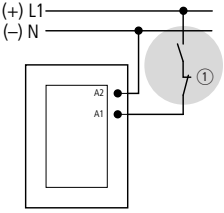
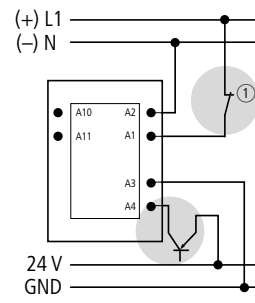
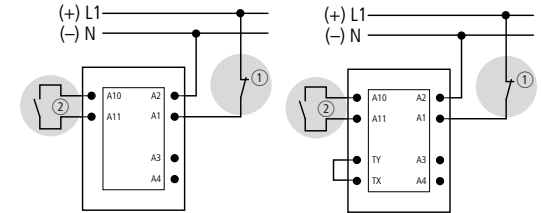
Part no.	Price See price list	Std. pack	Notes
<b>DILM185A/22(RAC240)<sup>1)</sup></b> 139537		1 off 	<p><b>Conventional</b> A1/A2 are attached to power supply as normal</p>  <p>DILM 185 A, DILM 225 A</p>
<b>DILM225A/22(RAC240)<sup>1)</sup></b> 139547			
<b>DILM250/22(RA250)<sup>2)</sup></b> 208201			<p><b>Directly from the PLC</b> A 24 V output from the PLC can be directly connected to the terminals A4/A24.</p>  <p>DILM250 to DILM1000, DILH1400</p>
<b>DILM300A/22(RA250)<sup>1) 2)</sup></b> 139556			
<b>DILM400/22(RA250)<sup>3)</sup></b> 208209			<p><b>From a low-power command device</b> Low-power actuating devices such as PCB relays, pilot devices or position switches can be directly connected to A10/A11.</p>  <p>DILM1600 to DILH 2600</p>
<b>DILM500/22(RA250)<sup>3)</sup></b> 208213			
<b>DILM580/22(RA250)<sup>3)</sup></b> 208216			<p>① Stopping in the event of an emergency (emergency switching off) ② Max. cable capacitance 6 nF</p>
<b>DILM650/22(RA250)<sup>3)</sup></b> 208219			
<b>DILM750/22(RA250)<sup>3)</sup></b> 208222			
<b>DILM820/22(RA250)<sup>3)</sup></b> 208225			
<b>DILM1000/22(RA250)<sup>3)</sup></b> 267214			
<b>DILM1600/22(RAW250)<sup>3)</sup></b> 106727			

Information relevant for export to North America



<sup>1)</sup> NA Certification	Request filed for UL and CSA
<sup>2)</sup> Product Standards	IEC/EN 60947-4-1; UL 508; CSA-C22.2 No. 14-05; CE marking
UL File No.	E29096
UL CCN	NLDX
CSA File No.	1017510
CSA Class No.	3211-04
NA Certification	UL Listed, CSA certified
<sup>3)</sup> Product Standards	IEC/EN 60947-4-1; UL 508; CSA-C22.2 No. 14-05; CE marking
UL File No.	E29096
UL CCN	NLDX
CSA File No.	012528
CSA Class No.	3211-04
NA Certification	UL Listed, CSA certified
See also	Additional approvals → Page 5/86

Conventional thermal current  $I_{th} = I_e$   
 AC-1 at 60 °C  
 Open  
 $I_{th} = I_e$   
 A

Circuit symbol

Part no.

Price  
 See price list

Std. pack

DILH comfort devices AC-1

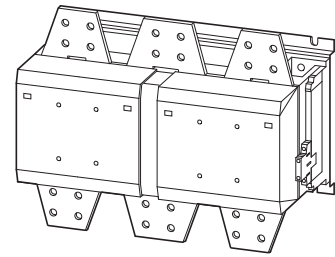

1400  
 2000  
 2200  
 2600

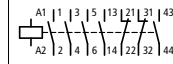

DILH1400/22(RAW250)<sup>1)</sup>  
 272441  
 DILH2000/22(RAW250)<sup>1)</sup>  
 272442  
 DILH2200/22(RAW250)<sup>1)</sup>  
 111793  
 DILH2600/22(RAW250)<sup>2)</sup>  
 125945

1 off

Notes

For all contactors the following applies:  
 • 660 V, 690 V or 1000 V: do not reverse directly  
 • Integrated suppressor circuit in actuating electronics.

When operating contactors DILM580 to DILM1600 behind a frequency inverter or mains with strong harmonic loads, the suppressor circuit on the load side must be removed.  
 During high-voltage tests, the suppressor circuit on the load-side for DILM580 to DILH2600 contactors must be disconnected (see instructional leaflet).

Control voltages  
 RAW250  $\Delta$  230 V - 250 V AC/DC

Accessories	Page
Auxiliary contact modules	→ 5/40
Suppressor circuits on load side	→ 5/65
Enclosures	<span style="border: 1px solid black; padding: 2px;">totally insulated</span>

Notes

Conventional

A1/A2 are attached to power supply as normal

DILH1400

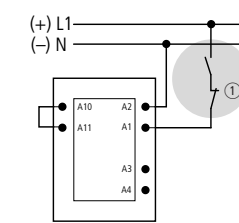

DILM1600 to DILH 2600

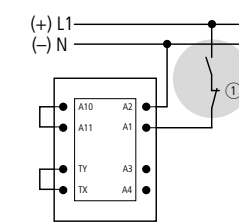

Directly from the PLC

A 24 V output from the PLC can be directly connected to the terminals A4/A24.

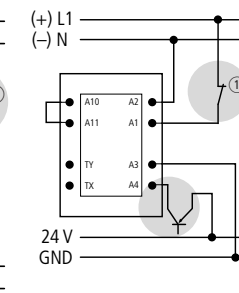
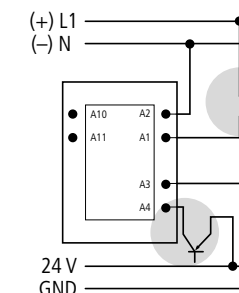
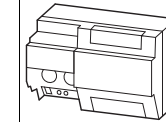

From a low-power command device

Low-power actuating devices such as PCB relays, pilot devices or position switches can be directly connected to A10/A11.

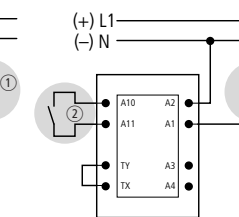
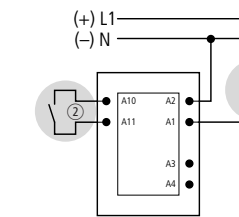

- ① Stopping in case of emergency (Emergency-stop)
- ② Max. cable capacitance 6 nF

Information relevant for export to North America



<sup>1)</sup>  
 Product Standards IEC/EN 60947-4-1; UL 508; CSA-C22.2 No. 14-05; CE marking  
 UL File No. E29096  
 UL CCN NLDX  
 CSA File No. 012528  
 CSA Class No. 3211-04  
 NA Certification UL Listed, CSA certified

<sup>2)</sup>  
 NA Certification Request filed for UL and CSA

Rated operational current open			Conventional thermal current $I_{th} = I_e$ AC-1 at 50 °C	Circuit symbol	For use with
40 °C	55 °C	70 °C			
A	A	A	Open		
			$I_{th} = I_e$		A

4 pole

Rated operational current open	Rated operational current open	Rated operational current open	Rated operational current open	Conventional thermal current	Circuit symbol	For use with
22	21	20	20	20		DILM32-XHI(C)... DILA-XHI(V)(C)...
32	30	28	32	32		DILM32-XHI(C)... DILA-XHI(V)(C)...
32	30	28	32	32		
45	41	39	45	45		
45	41	39	45	45		
63	60	54	63	63		DILM150-XHI(A)(V)... or DILM1000-XHI11-SA <sup>1)</sup> or DILM1000-XHI(V)11-SI <sup>1)</sup>
80	76	69	80	80		
125	116	108	125	125		DILM150-XHI(A)(V)... DILM1000-XHI(V)11-SI <sup>1)</sup>
160	150	138	160	160		
200	188	172	200	200		

- Notes**
- <sup>1)</sup> DILM1000-XHI... can only be fitted on the left of DILMP.
  - Contacts to EN 50012.
  - For DC operated contactors DILMP20 the following applies:
    - Integrated varistor suppressor circuit.
  - For DC operated contactors DILMP32 - DILMP200 the following applies:
    - Integrated suppressor circuit in actuating electronics.
  - For AC operated contactors DILMP125 - DILMP200 the following applies:
    - Integrated suppressor circuit in actuating electronics.
  - For DILMP32-01 and DILMP45-01 the following applies:
    - With mirror contact.

AC operation	Price	Std. pack	DC operation	Price	Std. pack	Notes
Part no. Article no.	See price list		Part no. Article no.	See price list		
DILMP20(230V50HZ,240V60HZ) 276970		1 off	DILMP20(24VDC) 276985		1 off	<p><b>Accessories</b></p> <ul style="list-style-type: none"> <li>1 Auxiliary contact module</li> <li>2 Suppressor</li> </ul> <p>Further actuating voltages Accessories</p> <p><b>Page</b></p> <ul style="list-style-type: none"> <li>→ 5/38</li> <li>→ 5/54</li> <li>→ 5/78</li> <li>→ 5/56</li> </ul>
DILMP32-01(230V50HZ,240V60HZ) 118911			DILMP32-01(RDC24) 118913			
DILMP32-10(230V50HZ,240V60HZ) 109797			DILMP32-10(RDC24) 109811			
DILMP45-01(230V50HZ,240V60HZ) 118914			DILMP45-10(RDC24) 109840			
DILMP45-10(230V50HZ,240V60HZ) 109826						
DILMP63(230V50HZ,240V60HZ) 109855			DILMP63(RDC24) 109869			
DILMP80(230V50HZ,240V60HZ) 109884			DILMP80(RDC24) 109898			
DILMP125(RAC240) 109905			DILMP125(RDC24) 109910			
DILMP160(RAC240) 109915			DILMP160(RDC24) 109920			
DILMP200(RAC240) 109925			DILMP200(RDC24) 109930			

Information relevant for export to North America

Product Standards	IEC/EN 60947-4-1; UL 508; CSA-C22.2 No. 14-05; CE marking
UL File No.	E29096
UL CCN	NLDX
CSA File No.	012528
CSA Class No.	2411-03, 3211-04
NA Certification	UL Listed, CSA certified
See also	→ Page 5/85

Terminal type	Pole	Conventional thermal current $I_{th} = I_e$ AC-1 at 60 °C Open $I_{th} = I_e$ A	Contact configuration	Circuit symbol	For use with	Part no.	Price See price list	Std. pack		
<b>Auxiliary contact modules</b>										
With interlocked opposing contacts, except ...XHI(C)V										
<b>Top mounting auxiliary contacts</b>										
	Screw terminals	2 pole	16	1 N/O	1 NC		DILM(C)7-10... DILM(C)9-10... DILM(C)12-10... DILM(C)15-10... DILM(C)17-10... DILM(C)25-10... DILM(C)32-10... DILM38-...10 DILMP20... DILMP32-10... DILMP45-10... DILL...	DILM32-XHI11 277376	5 off 	
				-	2 NC					DILM32-XHI02 277375
	Screw terminals	4 pole	16	2 N/O	2 NC		DILM32-XHI22 277377	DILM32-XHI31 106112		
				3 N/O	1 NC					DILM32-XHI31 106112
	Spring-loaded terminals	2 pole	16	1 N/O	1 NC		DILM32-XHIC11 277751	DILM32-XHIC02 277750		
				-	2 NC					DILM32-XHIC22 277752
	Spring-loaded terminals	4 pole	16	2 N/O	2 NC		DILM32-XHIC22 277752			
	Screw terminals	2 pole	16	2 N/O	-		DILM(C)7... DILM(C)9... DILM(C)12... DILM(C)15... DILM(C)17... DILM(C)25... DILM(C)32... DILM38... DILMP20... DILMP32... DILMP45... DILL...	DILA-XHI20 276422		
				1 N/O	1 NC					DILA-XHI11 276421
				-	2 NC					DILA-XHI02 276420
				1 S <sub>F</sub>	1 Ö <sub>S</sub>					DILA-XHIV11 276423
				4 N/O	-					DILA-XHI40 276428
				3 N/O	1 NC					DILA-XHI31 276427
				2 N/O	2 NC					DILA-XHI22 276426
				1 N/O	3 NC					DILA-XHI13 276425
				-	4 NC					DILA-XHI04 276424
				1 N/O 1 S <sub>F</sub>	1 NC 1 Ö <sub>S</sub>					DILA-XHIV22 276429

**Notes**

- Auxiliary NC usable as mirror contact according to IEC/EN 60947-4-1, Annex F
- Interlocked opposing contacts according to IEC/EN 60947-5-1 Annex L, inside the auxiliary contact modules, also for the integrated auxiliary contacts of the DILM 7 - DILM32

















**Information relevant for export to North America**



Product Standards	IEC/EN 60947-4-1; UL 508; CSA-C22.2 No. 14-05; CE marking
UL File No.	E29184
UL CCN	NKCR
CSA File No.	012528
CSA Class No.	3211-03
NA Certification	UL Listed, CSA certified



HPL05039EN























Terminal type	Pole	Conventional thermal current $I_{th} = I_e$ AC-1 at 60 °C	Contact configuration	Circuit symbol	For use with	Part no.	Price See price list	Std. pack	
<b>Auxiliary contact modules</b>									
With interlocked opposing contacts, except ...XHI(C)V									
<b>Top mounting auxiliary contacts</b>									
	2 pole	16	2 N/O	—		DILM(C)7... DILM(C)9... DILM(C)12... DILM(C)15... DILM(C)17... DILM(C)25... DILM(C)32... DILM38... DILMP20... DILMP32... DILMP45... DILL...	<b>DILA-XHIC20</b> 276528	5 off 	
			1 N/O	1 NC					<b>DILA-XHIC11</b> 276527
			—	2 NC					<b>DILA-XHIC02</b> 276526
			1 S <sub>F</sub>	1 Ö <sub>S</sub>					<b>DILA-XHICV11</b> 276529
	2 pole	16	2 N/O	2 NC		DILM(C)7... DILM(C)9... DILM(C)12... DILM(C)15... DILM(C)17... DILM(C)25... DILM(C)32...	<b>DILA-XHIR22<sup>1)</sup></b> 139580		
		16	1 N/O	1 NC			<b>DILA-XHIR11</b> 110140		
	4 pole	16	4 N/O	—		DILM(C)7... DILM(C)9... DILM(C)12... DILM(C)15... DILM(C)17... DILM(C)25... DILM(C)32...	<b>DILA-XHIC40</b> 276534		
			3 N/O	1 NC			<b>DILA-XHIC31</b> 276533		
			2 N/O	2 NC			<b>DILA-XHIC22</b> 276532		
			1 N/O	3 NC			<b>DILA-XHIC13</b> 276531		
			—	4 NC			<b>DILA-XHIC04</b> 276530		
			1 N/O 1 S <sub>F</sub>	1 NC 1 Ö <sub>S</sub>			<b>DILA-XHICV22</b> 276535		

**Notes**

- Auxiliary NC usable as mirror contact according to IEC/EN 60947-4-1, Annex F
  - Interlocked opposing contacts according to IEC/EN 60947-5-1 Annex L, inside the auxiliary contact modules, also for the integrated auxiliary contacts of the DILM 7 - DILM32
- <sup>1)</sup> 1 N/C + 1 N/O above microswitch for electronic applications

**Information relevant for export to North America**

	Product Standards	IEC/EN 60947-4-1; UL 508; CSA-C22.2 No. 14-05; CE marking
	UL File No.	E29184
	UL CCN	NKCR
	CSA File No.	012528
	CSA Class No.	3211-03
	NA Certification	UL Listed, CSA certified
	<sup>1)</sup> NA Certification	Request filed for UL and CSA

Connection type	Pole	conventional thermal current $I_{th} = I_e$ AC-1 at 60 °C  Open $I_{th} = I_e$ A	Contact configuration N/O = normally open contact SF = N/O early make NC = normally closed contact ÖS = NC late-break	Circuit symbol	For use with	Part no. Article no.	Price See price list	Std. pack	Notes
<b>Auxiliary contact modules</b>									
With interlocked opposing contacts									
<b>Top mounting auxiliary contacts</b>									
	Screw terminals	2 pole	16	2 N/O	—		DILM40... DILM50... DILM65... DILM72... DILM80... DILM95... DILM115... DILM150... DILM170...	<b>DILM150-XHI20</b> 277945	5 off  Interlocked opposing contacts according to IEC/EN 60947-5-1 Annex L, inside the auxiliary contact modules Auxiliary NC usable as mirror contact according to IEC/EN 60947-4-1, Annex F
				1 N/O	1 NC		DILM63... DILM80... DILM95... DILM115... DILM150... DILM170... DILM195... DILM215... DILM240...	<b>DILM150-XHI11</b> 277946	
				1 N/O	1 NC		DILM63... DILM80... DILM95... DILM115... DILM150... DILM170... DILM195... DILM215... DILM240...	<b>DILM150-XHIA11</b> 283463	
				—	2 NC		DILM63... DILM80... DILM95... DILM115... DILM150... DILM170... DILM195... DILM215... DILM240...	<b>DILM150-XHI02</b> 277947	
	Screw terminals	4 pole	16	4 N/O	—		DILM150... DILM160... DILM200...	<b>DILM150-XHI40</b> 277948	
				3 N/O	1 NC		DILM150... DILM160... DILM200...	<b>DILM150-XHI31</b> 277949	
				2 N/O	2 NC		DILM150... DILM160... DILM200...	<b>DILM150-XHI22</b> 277950	
				2 N/O	2 NC		DILM150... DILM160... DILM200...	<b>DILM150-XHIA22</b> 283464	
				1 N/O	3 NC		DILM150... DILM160... DILM200...	<b>DILM150-XHI13</b> 277951	
				—	4 NC		DILM150... DILM160... DILM200...	<b>DILM150-XHI04</b> 277952	
				1 N/O	1 NC		DILM150... DILM160... DILM200...	<b>DILM150-XHIV22</b> 277953	
				1 S <sub>F</sub>	1 Ö <sub>S</sub>		DILM150... DILM160... DILM200...		
	Screw terminals	2 pole	16	2 N/O	—		DILM7... DILM9... DILM12... DILM15... DILL...	<b>DILA-XHIT20</b> 101042	5 off  Interlocked opposing contacts according to IEC/EN 60947-5-1 Annex L, inside the auxiliary contact modules Auxiliary NC usable as mirror contact according to IEC/EN 60947-4-1, Annex F
				1 N/O	1 NC		DILM7... DILM9... DILM12... DILM15... DILL...	<b>DILA-XHIT11</b> 101043	
	Screw terminals	4 pole	16	—	2 NC		DILM7... DILM9... DILM12... DILM15... DILL...	<b>DILA-XHIT02</b> 101041	
				2 N/O	2 NC		DILM7... DILM9... DILM12... DILM15... DILL...	<b>DILA-XHIT22</b> 101044	

**Notes**

<sup>1)</sup> Suitable for the combination with electrical wiringlinks in tool-less plug connection usable with:  
DILM12-XSL  
DILM12-XRL  
DILM12-XS1  
PKZM0-XDM12  
PKZM0-XRM12  
PKZM0-XSM12

- 1 PKZM0
- 2 DILM7 - DILM15
- 3 DILA-XHIT
- 4 PKZM0-XDM12

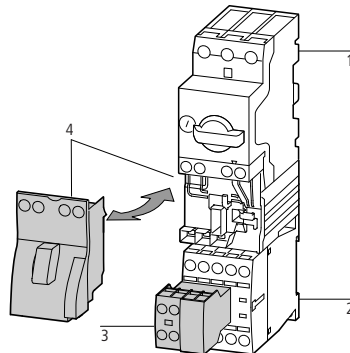











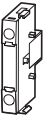











**Information relevant for export to North America**



Product Standards IEC/EN 60947-4-1;  
UL 508; CSA-C22.2  
No. 14-05; CE marking  
UL File No. E29184  
UL CCN NKCR  
CSA File No. 012528  
CSA Class No. 3211-03  
NA Certification UL Listed,  
CSA certified

HPL05041EN

DILA, DILM

Connection type	Pole	conventional thermal current $I_{th} = I_e$ AC-1 at 60 °C Open $I_{th} = I_e$ A	Contact configuration N/O = normally open contact SF = N/O early make NC = normally closed contact ÖS = NC late-break	Circuit symbol	For use with	Part no. Article no.	Price See price list	Std. pack	Notes
<b>Side-mounting auxiliary contacts</b>									
	Screw terminals	1 pole	10	1 N/O	—		DILM(C)7... DILM(C)9... DILM(C)12... DILM(C)15... DILMP20... DILA(C)...	1 off 	1) 
				—	1 NC				
	Spring-loaded terminals	1 pole	10	1 N/O	—		DILM17... DILM25... DILM32... DILM38...	1 off 	1)
				—	1 NC				
	Screw terminals	2 pole	10	1 N/O	1 NC		DILM17... DILM25... DILM32... DILM38...	1 off 	1) Can only be left on the contactor. Cannot be combined with mechanical interlock
<b>Side-mounting auxiliary contacts</b>									
	Screw terminals	2 pole	10	1 N/O	1 NC		DILM250 - DILH2600	1 off 	1)
			10	1 N/O	1 NC				
			10	1 SF	1 ÖS				
	Screw terminals	2 pole	10	1 N/O	1 NC		DILM40 - DILM225A DILMP63 - DILMP200	1 off 	1)
			10	1 SF	1 ÖS				
			10	1 N/O	1 NC				

Notes

- 1)
- Interlocked opposing contacts according to IEC/EN 60947-5-1 Annex L, inside the auxiliary contact module, also for the integrated auxiliary contacts of the DILM7 – DILM32 (not NO early-make and NC late-break)
  - Auxiliary NC usable as mirror contact according to IEC/EN 60947-4-1, Annex F (no NC late-breaks)
  - No auxiliary contact is possible between 2 contactors with mechanical interlock.

Information relevant for export to North America



2)

Product Standards IEC/EN 60947-4-1;  
 UL 508; CSA-C22.2 No. 14-05;  
 CE marking  
 UL File No.E29184  
 UL CCNNKCR  
 CSA File No.012528  
 CSA Class No.3211-03, 3211-04  
 NA Certification UL Listed,  
 CSA certified

Engineering

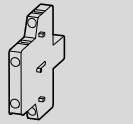
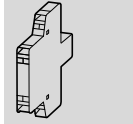
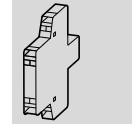
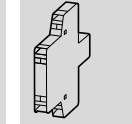
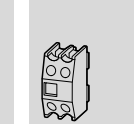
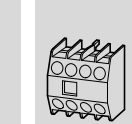
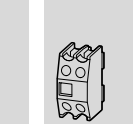
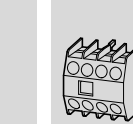
								
DILM40	2 x	–	–	–	–	–	1 x	–
... DILM72	–	–	2 x	–	1 x	–	–	–
	1 x	–	–	–	–	–	–	1 x
	–	–	1 x	–	–	1 x	–	–
DILM80	2 x	–	2 x	–	–	–	–	–
... DILM170	2 x	–	–	–	–	–	–	1 x
	2 x	–	–	–	–	–	1 x	–
	–	–	2 x	–	–	1 x	–	–
	–	–	2 x	–	1 x	–	–	–
DILM185A	2 x	–	2 x	–	–	–	–	–
DILM222A	2 x	–	–	–	–	–	–	–
DILM250 DILM1600	–	2 x	–	2 x	–	–	–	–
DILH1400 ... DILH2600	–	2 x	–	2 x	–	–	–	–

Notes

Side mounting auxiliary contacts

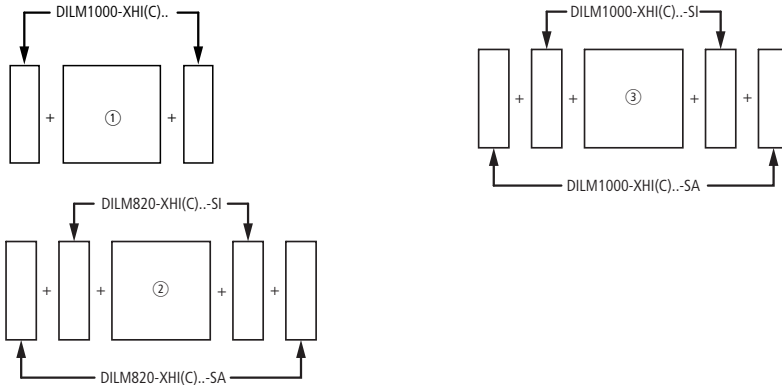



- ① DILM40 – DILM72
- ② DILM250 – DILH2600
- ③ DILM80-DILM225A

- Interlocked opposing contacts according to IEC/EN 60947-5-1 Annex L, inside the auxiliary contact module (not N/O early close and N/C late open)
- Auxiliary contacts can be used as mirror contacts according to IEC/EN 60947-4-1, Annex F (not N/C late open)
- No auxiliary contact is possible between two contactors with mechanical interlock.
- 2 auxiliary contacts DILM820-XHI11-SI are already built into the contactors DILM250 to DILH2600/22.
- 2 DILM1000-XHI11-SI auxiliary contacts are already installed in DILM185A and DILH225A contactors.

HPL05043EN

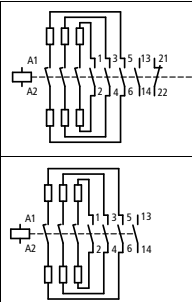
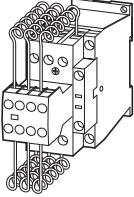
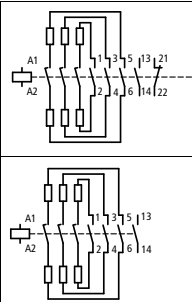
## Ordering

	Circuit symbol	Part no. Article no.	Price See price list	Std. pack																			
Three-phase capacitors 50 – 60 Hz Open <table style="width: 100%; text-align: center; border-collapse: collapse;"> <tr> <td style="border-right: 1px solid black; width: 25%;">230 V</td> <td style="border-right: 1px solid black; width: 25%;">400 V</td> <td style="border-right: 1px solid black; width: 25%;">525 V</td> <td style="width: 25%;">690 V</td> </tr> <tr> <td style="border-right: 1px solid black;">kvar</td> <td style="border-right: 1px solid black;">kvar</td> <td style="border-right: 1px solid black;">kvar</td> <td>kvar</td> </tr> </table>	230 V	400 V	525 V	690 V	kvar	kvar	kvar	kvar															
230 V	400 V	525 V	690 V																				
kvar	kvar	kvar	kvar																				
With series resistors Basic Units  <table style="width: 100%; text-align: center; border-collapse: collapse;"> <tr> <td style="border-right: 1px solid black; width: 12.5%;">7.5</td> <td style="border-right: 1px solid black; width: 12.5%;">12.5</td> <td style="border-right: 1px solid black; width: 12.5%;">16.7</td> <td style="width: 12.5%;">20</td> </tr> <tr> <td style="border-right: 1px solid black;">11</td> <td style="border-right: 1px solid black;">20</td> <td style="border-right: 1px solid black;">25</td> <td>33.3</td> </tr> <tr> <td style="border-right: 1px solid black;">15</td> <td style="border-right: 1px solid black;">25</td> <td style="border-right: 1px solid black;">33.3</td> <td>40</td> </tr> <tr> <td style="border-right: 1px solid black;">20</td> <td style="border-right: 1px solid black;">33.3</td> <td style="border-right: 1px solid black;">40</td> <td>55</td> </tr> <tr> <td style="border-right: 1px solid black;">25</td> <td style="border-right: 1px solid black;">50</td> <td style="border-right: 1px solid black;">65</td> <td>85</td> </tr> </table>	7.5	12.5	16.7	20	11	20	25	33.3	15	25	33.3	40	20	33.3	40	55	25	50	65	85		<b>DILK12-11(230V50HZ,240V60HZ)</b> 293988 <b>DILK20-11(230V50HZ,240V60HZ)</b> 294010 <b>DILK25-11(230V50HZ,240V60HZ)</b> 294032 <b>DILK33-10(230V50HZ,240V60HZ)</b> 294054 <b>DILK50-10(230V50HZ,240V60HZ)</b> 294076	1 Off 
7.5	12.5	16.7	20																				
11	20	25	33.3																				
15	25	33.3	40																				
20	33.3	40	55																				
25	50	65	85																				

### Notes

Weld-resistant for capacitors with inrush current peaks up to  $180 \times I_N$   
 With group compensation multi-stage capacitor banks are connected to the mains as required. This can cause, transient currents of up to  $180 \times I_e$  to flow between the capacitors.  
 The capacitors are pre-charged via the early-make auxiliary contacts and the fitted wire resistors, thereby reducing the inrush current. The main contacts then close after a time lag and carry the continuous current.  
 The contactors for capacitors are weld-resistant with inrush current peaks up to  $180 \times I_e$  due to their special contacts.  
 DILK... cannot be combined with other auxiliary contacts.  
 For the switching of reactive-power compensation equipment please see Engineering notes on power factor correction → page 5/35.

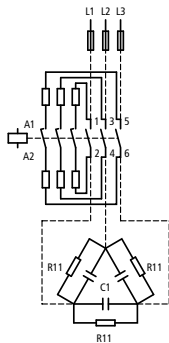

Accessories	Page
Enclosures <span style="border: 1px solid black; padding: 2px;">totally insulated</span>	
Accessories	→ 5/56
Further actuating voltages	→ 5/80

### Information relevant for export to North America



Product Standards	IEC/EN 60947-4-1; UL 508; CSA-C22.2 No. 14-05; CE marking
UL File No.	E29096
UL CCN	NLDX
CSA File No.	012528
CSA Class No.	3211-04
NA Certification	UL Listed, CSA certified
See also	Further approvals → page 5/70

## Engineering









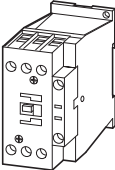

Part no.	Page	Switching power			
		230 V	400 V 420 V 440 V	525 V	690 V
		kvar	kvar	kvar	kvar
<b>Individual compensation, open version</b>					
DILM7-...(…)	→ 5/18	1.5	3	3.5	5
DILM9-...(…)	→ 5/18	2	4	4.5	6
DILM12-...(…)	→ 5/18	2.5	4.5	5.5	7
DILM15-...(…)	→ 5/18	2.5	4.5	5.5	7
DILM17-...(…)	→ 5/18	6.5	12	14.5	19
DILM25-...(…)	→ 5/18	7	13.5	16	21
DILM32-...(…)	→ 5/18	7.5	14.5	17	22.5
DILM40(…)	→ 5/20	11	20.5	24.5	32
DILM50(…)	→ 5/20	11.5	22	26	34.5
DILM65(…)	→ 5/20	12.5	23.5	28	37
DILM80(…)	→ 5/20	16	30.5	36.5	48
DILM95(…)	→ 5/20	18	34	41	54
DILM115(…)	→ 5/20	24	46	54.5	72
DILM150(…)	→ 5/20	28	53	63.5	83.5
DILM185A(…)	→ 5/32	87	150	190	150
DILM300A(…)	→ 5/32	115	200	265	200
DILM580(…)	→ 5/32	175	300	400	300
<b>Group compensation, with choke, open version</b>					
DILM7-...(…)	→ 5/18	4	7	7.5	12
DILM9-...(…)	→ 5/18	5	8	10	14
DILM12-...(…)	→ 5/18	5.5	10	12	16
DILM15-...(…)	→ 5/18	5.5	10	12	16
DILM17-...(…)	→ 5/18	7.5	18	20	28
DILM25-...(…)	→ 5/18	10	20	23	30
DILM32-...(…)	→ 5/18	12.5	25	25	32
DILM40(…)	→ 5/20	15	30	30	40
DILM50(…)	→ 5/20	20	40	40	48
DILM65(…)	→ 5/20	25	50	50	57
DILM80(…)	→ 5/20	30	60	70	90
DILM95(…)	→ 5/20	35	70	80	104
DILM115(…)	→ 5/20	50	95	100	125
DILM150(…)	→ 5/20	55	115	115	152
DILM185A(…)	→ 5/32	80	150	200	260
DILM225A(…)	→ 5/32	100	175	230	300
DILM250(…)	→ 5/32	110	190	260	340
DILM300A(…)	→ 5/32	130	225	290	390
DILM400(…)	→ 5/32	160	280	370	480
DILM500(…)	→ 5/32	220	390	500	680
<b>Group compensation, without choke, open version</b>					
DILK12-...(…)	→ 5/43	7.5	12.5	16.7	20
DILK20-...(…)	→ 5/43	11	20	25	33.3
DILK25-...(…)	→ 5/43	15	25	33.3	40
DILK33-...(…)	→ 5/43	20	33.3	40	55
DILK50-...(…)	→ 5/43	25	50	65	85
DILM185A(…)	→ 5/32	66	115	145	115
DILM300A(…)	→ 5/32	85	150	195	150
DILM580(…)	→ 5/32	145	250	333	250

## Notes

**Use of the contactors DILM without series resistor for group compensation**

When using the contactors for group compensation in a system without chokes each capacitor must have a minimum induction of approx. 6 µH to limit the peak inrush current. This corresponds to an air-cored coil with 5 windings and a coil diameter of approximately Ø 140 mm. The conductor cross section must correspond to the rated operational current.

Ordering

Rated operational current		Conventional thermal current		Circuit symbol	Part no. Article no.	Price See price list	Std. pack	
AC-5a operation		AC-5b operation						Open
230 V	400 V	230 V	400 V	$I_{th} = I_e$				
$I_e$	$I_e$	$I_e$	$I_e$	A				
A	A	A	A					
<b>Illumination contactors DILL</b>								
	12	12	14	14	24		<b>DILL12(230V50HZ,240V60HZ)</b> 104402	1 Off 
	12	12	14	14	24		<b>DILL12(24V50HZ)</b> 104401	
	12	12	14	14	24		<b>DILL12(400V50HZ,440V60HZ)</b> 104403	
	18	18	21	21	35		<b>DILL18(230V50HZ,240V60HZ)</b> 104405	
	18	18	21	21	35		<b>DILL18(24V50HZ)</b> 104404	
	18	18	21	21	35		<b>DILL18(400V50HZ,440V60HZ)</b> 104406	
	20	20	27	27	40		<b>DILL20(230V50HZ,240V60HZ)</b> 104408	
	20	20	27	27	40		<b>DILL20(24V50HZ)</b> 104407	
	20	20	27	27	40		<b>DILL20(400V50HZ,440V60HZ)</b> 104409	

**Notes** DILL do not have an integrated auxiliary contact. They can be combined with DILM32-XHI... and DILA-XHI... auxiliary contacts.  
Switchgear for illumination systems → page 5/46

**Information relevant for export to North America**

	Product Standards	IEC/EN 60947-4-1; UL 508; CSA-C22.2 No. 14-05; CE marking
	UL File No.	E29096
	UL CCN	NLDX
	CSA File No.	012528
	CSA Class No.	3211-04
	NA Certification	UL Listed, CSA certified

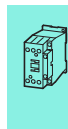

## Engineering

	DIL	L12	L18	L20	M7	M9	M12	M17	M25	M32	M40	M50
Permissible compensation capacitance	$C_{max}$ [mF]	470	470	470	47	80	100	220	330	470	470	500
Filament bulbs	$I_e$ [A]	14	21	27	6	7.5	10	14	21	27	33	42
Mercury blended lamps	$I_e$ [A]	12	16	23	5	6.5	8.5	12	16	23	30	38
Fluorescent lamps, conventional reactor – starter – connection	$I_e$ [A]	20	26	35	9	10	15	20	26	35	41	45
Fluorescent lamps, duo circuit (series compensated)	$I_e$ [A]	20	26	35	5.5	8	13	15	22.5	29	36	47
Electronic upstream devices	$I_e$ [A]	12	18	20	5	6.5	8.5	12	17.5	22.5	28	35
High-pressure mercury vapour lamps	$I_e$ [A]	12	18	20	3.5	6	10	12	17.5	20	25	30
Metal-halide lamps	$I_e$ [A]	12	18	20	3.5	6	10	12	17.5	20	25	30
High-pressure sodium lamps	$I_e$ [A]	12	18	20	3.5	6	10	12	17.5	20	25	30
Low-pressure sodium lamps	$I_e$ [A]	7.5	10	12	3	4	6	7.5	10	12	15	22

	DIL	M65	M80	M95	M115	M150	M185A	M225A	M250	M300A	M400	M500
Permissible compensation capacitance	$C_{max}$ [mF]	500	550	620	830	970	2055	2300	2600	3000	3250	3500
Filament bulbs	$I_e$ [A]	55	67	79	95	125	153	187	208	249	332	415
Mercury blended lamps	$I_e$ [A]	45	65	67	80	110	123	150	167	200	266	332
Fluorescent lamps, conventional reactor – starter – connection	$I_e$ [A]	55	95	100	125	145	207	237	263	300	375	525
Fluorescent lamps, duo circuit (series compensated)	$I_e$ [A]	59	71	95	100	138	186	213	236	270	338	473
Electronic upstream devices	$I_e$ [A]	45.5	56	66.5	80.5	105	130	158	175	210	280	350
High-pressure mercury vapour lamps	$I_e$ [A]	36	55	60	80	95	138	158	175	200	250	350
Metal-halide lamps	$I_e$ [A]	36	55	60	80	95	138	158	175	200	250	350
High-pressure sodium lamps	$I_e$ [A]	36	55	60	80	95	138	158	175	200	250	350
Low-pressure sodium lamps	$I_e$ [A]	25	35	40	50	70	100	111	123	140	175	245





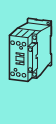



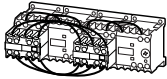
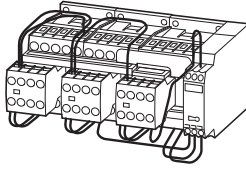
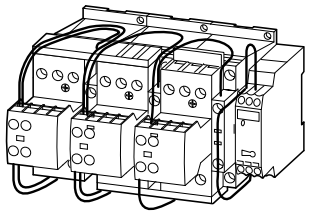



















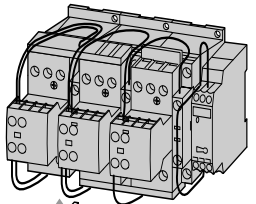
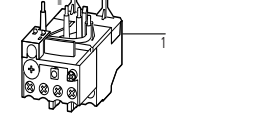

















In compensated lamps, the sum of the capacitances must not exceed the contactors' max. permissible capacitor load ( $C_{max}$ )!  
The values in the table are for each individual contactor contact.





Ordering

Rated operational current AC-3	Max. rated operational power for three-phase motors, 50 - 60 Hz AC-3					Max. change-over time	Part no. Article no.	Price See price list	Std. pack
	400 V I <sub>e</sub> A	230 V P kW	400 V P kW	500 V P kW	690 V P kW				
<b>Star-delta combinations SDAINL</b>									
Operating frequency: maximum 30 starts per hour									
	12	4	5.5	5.5	-	< 30	SDAINLEM(230V50HZ) 051840		1 Off
	12	3	5.5	5.5	5.5	< 20	SDAINLM12(230V50HZ) 278286		
	12	3	5.5	5.5	5.5	< 20	SDAINLM12(400V50HZ) 101380		
	12	3	5.5	5.5	5.5	< 20	SDAINLM12(24VDC) 100416		
	16	4	7.5	7.5	7.5	< 20	SDAINLM16(230V50HZ) 278311		
	16	4	7.5	7.5	7.5	< 20	SDAINLM16(400V50HZ) 101381		
	16	4	7.5	7.5	7.5	< 20	SDAINLM16(24VDC) 100417		
	22	5.5	11	11	11	< 20	SDAINLM22(230V50HZ) 278336		
	22	5.5	11	11	11	< 20	SDAINLM22(400V50HZ) 101382		
	22	5.5	11	11	11	< 20	SDAINLM22(24VDC) 100418		
	30	7.5	15	18.5	18.5	< 20	SDAINLM30(230V50HZ) 278361		
	30	7.5	15	18.5	18.5	< 20	SDAINLM30(400V50HZ) 101383		
	30	7.5	15	18.5	18.5	< 20	SDAINLM30(RDC24) 100419		
	45	11	22	30	22	< 20	SDAINLM45(230V50HZ) 278386		
	45	11	22	30	22	< 20	SDAINLM45(400V50HZ) 101384		
	45	11	22	30	22	< 20	SDAINLM45(RDC24) 100420		
	55	15	30	37	30	< 20	SDAINLM55(230V50HZ) 278411		
	55	15	30	37	30	< 20	SDAINLM55(400V50HZ) 101385		
	55	15	30	37	30	< 20	SDAINLM55(RDC24) 100421		
	70	18.5	37	45	37	< 20	SDAINLM70(230V50HZ) 239895		
	70	18.5	37	45	37	< 20	SDAINLM70(400V50HZ) 101386		
	90	22	45	55	45	< 20	SDAINLM90(230V50HZ) 239937		
	115	30	55	75	55	< 20	SDAINLM115(230V50HZ) 239963		
	140	37	75	90	90	< 20	SDAINLM140(230V50HZ) 240009		
	165	45	90	110	132	< 20	SDAINLM165(230V50HZ) 240035		
	200	55	110	132	160	< 20	SDAINLM200(230V50HZ) 101010		
	260	75	132	160	160	< 20	SDAINLM260(230V50HZ) 101031		

Individual components of the combination				Spare auxiliary contacts			Notes
Mains contactor Q11	Delta contactor Q15	Star contactor Q13	Timing relays K1	Q11	Q13	Q15	
Part no.	Part no.	Part no.	Part no.				
DILEM-10 + 22DILEM	DILEM-01	DILEM-10 + 02DILEM	DILET		-	-	Main circuit: Depending on the type of coordination required (i.e. Type "1" or Type "2") it must be established whether the fuse protection and the input wiring for the mains contactor and delta contactor are to be common or separate.
DILM7-10 + DILA-XHI20	DILM7-01 + DILA-XHI20	DILM7-01 + DILA-XHI20	ETR4-51				
DILM7-10 + DILA-XHI20	DILM7-01 + DILA-XHI20	DILM7-01 + DILA-XHI20	ETR4-51				The following applies for SDAINLM 140 – SDAINLM 260: • On the mounting plate.
DILM7-10 + DILA-XHI20	DILM7-01 + DILA-XHI20	DILM7-01 + DILA-XHI20	ETR4-51				
DILM9-10 + DILA-XHI20	DILM9-01 + DILA-XHI20	DILM7-01 + DILA-XHI20	ETR4-51				Circuit diagrams, Star-delta combinations → page 5/50
DILM9-10 + DILA-XHI20	DILM9-01 + DILA-XHI20	DILM7-01 + DILA-XHI20	ETR4-51				
DILM12-10 + DILA-XHI20	DILM12-01 + DILA-XHI20	DILM7-01 + DILA-XHI20	ETR4-51				 
DILM12-10 + DILA-XHI20	DILM12-01 + DILA-XHI20	DILM7-01 + DILA-XHI20	ETR4-51				
DILM17-10 + DILA-XHI20	DILM17-01 + DILA-XHI20	DILM17-01 + DILA-XHI20	ETR4-51				Accessories 1 Overload relay Accessories
DILM17-10 + DILA-XHI20	DILM17-01 + DILA-XHI20	DILM17-01 + DILA-XHI20	ETR4-51				
DILM25-10 + DILA-XHI20	DILM25-01 + DILA-XHI20	DILM17-01 + DILA-XHI20	ETR4-51				Page → 6/8 → 5/56
DILM25-10 + DILA-XHI20	DILM25-01 + DILA-XHI20	DILM17-01 + DILA-XHI20	ETR4-51				
DILM32-10 + DILA-XHI20	DILM32-01 + DILA-XHI20	DILM25-01 + DILA-XHI20	ETR4-51				
DILM32-10 + DILA-XHI20	DILM32-01 + DILA-XHI20	DILM25-01 + DILA-XHI20	ETR4-51				
DILM40 + DILM150-XHI31	DILM40 + DILM150-XHI11	DILM40 + DILM150-XHI11	ETR4-51		-	-	
DILM40 + DILM150-XHI31	DILM40 + DILM150-XHI11	DILM40 + DILM150-XHI11	ETR4-51		-	-	
DILM50 + DILM150-XHI31	DILM50 + DILM150-XHI11	DILM40 + DILM150-XHI11	ETR4-51		-	-	
DILM65 + DILM150-XHI31	DILM65 + DILM150-XHI11	DILM40 + DILM150-XHI11	ETR4-51		-	-	
DILM80 + DILM150-XHI31	DILM80 + DILM150-XHI11	DILM50 + DILM150-XHI11	ETR4-51		-	-	
DILM95 + DILM150-XHI31	DILM95 + DILM150-XHI11	DILM65 + DILM150-XHI11	ETR4-51		-	-	
DILM115 + DILM150-XHI31	DILM115 + DILM150-XHI11	DILM80 + DILM150-XHI11	ETR4-51		-	-	
DILM150 + DILM150-XHI31	DILM150 + DILM150-XHI11	DILM95 + DILM150-XHI11	ETR4-51		-	-	

## Engineering

### Circuit diagrams, Star-delta combinations

SDAINLEM

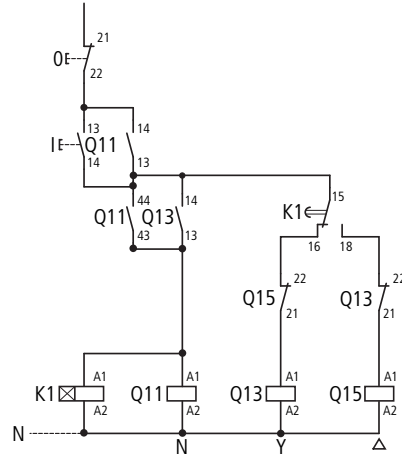
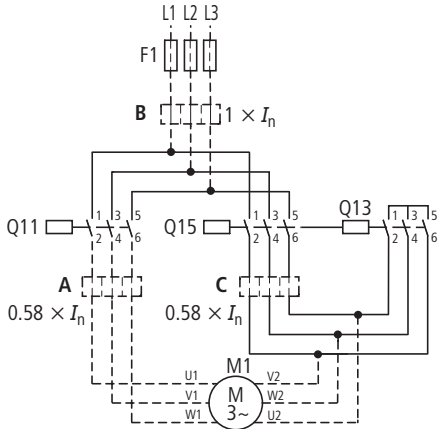

SDAINLM12...SDAINLM55

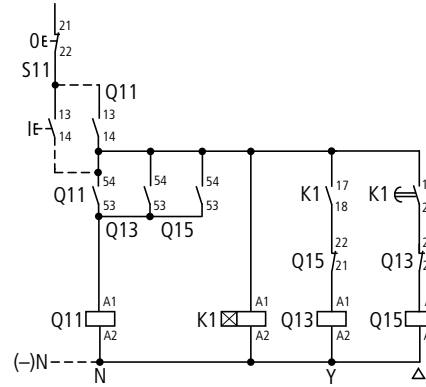
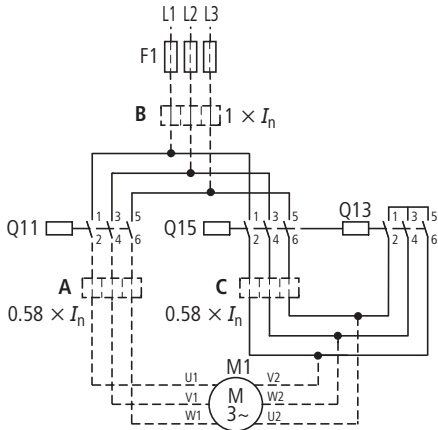

SDAINLM70...SDAINLM260

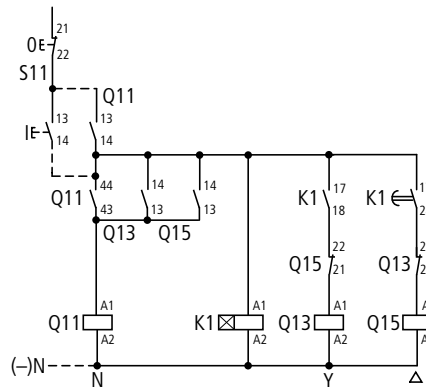
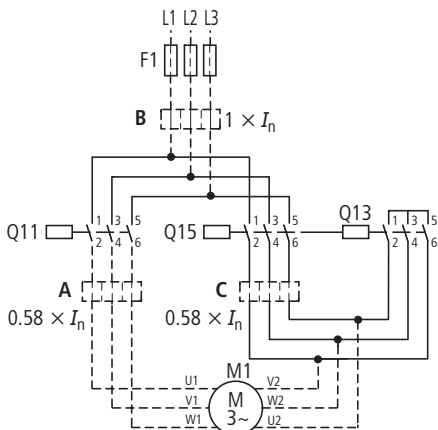

**Overload relay settings**

**A:**  $I_N \times 0.58$   
Motor protected in Y and  $\Delta$ - positions

**B:**  $I_N \times 1$   
Only partial motor protection in Y position

**C:**  $I_N \times 0.58$   
Motor not protected in Y position

Timing relay set to approx. 10 s

Main circuit:

Depending on the type of coordination required (i.e. Type "1" or Type "2") it must be established whether the fuse protection and the input wiring for the mains contactor and delta contactor are to be common or separate.

**Starting**

F 15 s

15 – 40 s

> 40 s

#### Components for self-assembly of star-delta combinations

Maximum operational rating of AC motors 50 - 60 Hz

AC-3					Changeover time <sup>1)</sup>			Individual components of the combination				Spare auxiliary contacts			
230 V	400 V	500 V	690 V	1000 V	up to 12 s	up to 20 s	up to 30 s	Coil to EN 50005 Switching element to EN 50005 and EN 50012	Mains contactor Q11	Delta contactor Q15	Star contactor Q13	Timing relay K1	Q11	Q15	Q13
kW	kW	kW	kW	kW				Part no. DIL	Part no. DIL	Part no. DIL	Part no.				
90	160	200	250	132	●	●	●	M185A/22	M185A/22	M115/22	ETR4-51				
110	200	250	315	160	●	●	—	M225A/22	M225A/22	M150/22	ETR4-51				
132	250	315	400	200	●	●	●	M250/22	M250/22	M185A/22	ETR4-51				
160	300	355	450	200	●	●	●	M300A/22	M300A/22	M185A/22	ETR4-51				
200	355	450	560	220	●	●	—	M400/22	M400/22	M250/22	ETR4-51				
250	450	560	600	220	●	●	●	M500/22	M500/22	M300A/22	ETR4-51				
300	560	710	900	355	●	●	●	M580/22	M580/22	M400/22	ETR4-51				
350	630	750	950	355	●	●	●	M650/22	M650/22	M400/22	ETR4-51				
400	710	900	1200	1400	●	●	●	M750/22	M750/22	M580/22	ETR4-51				
450	800	950	1300	1400	●	●	●	M820/22	M820/22	M580/22	ETR4-51				
560	1000	1200	1700	1700	●	●	—	M1000/22	M1000/22	M650/22	ETR4-51				

#### Notes

<sup>1)</sup> Longer changeover times please enquire

#### Components for self-assembly

#### Notes

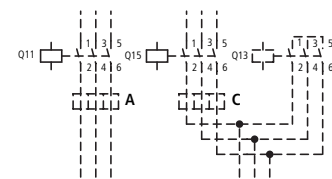
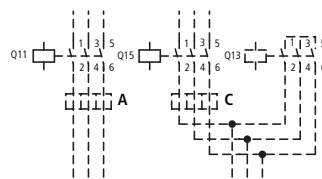
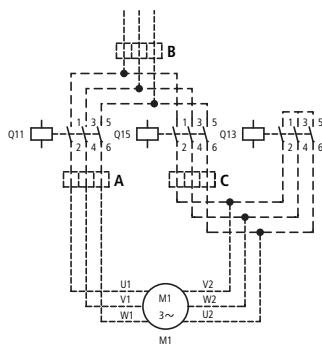

#### Overload relay settings

Timing relay set to approx. 10 s

$I_N$

#### Starting

Main circuit:

Depending on the coordination type required (i.e. Type "1" or Type "2") it must be established whether the fuse protection and the input wiring for the mains contactor and delta contactor are to be common or separate.

**A x 0.58**  
Motor protection in Y and  $\Delta$  positions

≤ 15 s

**B x 1**  
In Y position only limited motor protection

15 – 40 s



Control circuit:

If the combinations are to be used within the scope of IEC/EN 60 204 Part 1, VDE 0113 Part 1, then Point 9.1.1 regarding the supply of control circuits, must be observed.

**C x 0.58**  
Motor not protected in Y position

> 40 s

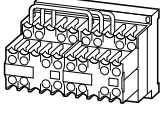
Ordering

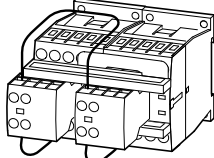
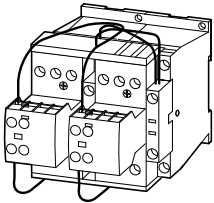
Rated operational current AC-3	Max. motor rating for three-phase motors 50 - 60 Hz			Part no.	Price See price list	Std. pack			
	AC-3		AC-4						
	400 V	220 V 230 V	380 V 400 V				660 V 690 V	220 V 230 V	380 V 400 V
I <sub>e</sub>	P	P	P	P	P	P			
A	kW	kW	kW	kW	kW	kW			
<b>DIUL reversing combinations</b>									
<b>AC operation</b>									
	9	2.2	4	4	1.5	3	3	<b>DIULEM/21(MV(230V50HZ))<sup>1)</sup></b> 051849	1 Off 
	9	2.2	4	4	1.5	3	3		
	7	2.2	3	3.5	1	2.2	2.9	<b>DIULM7/21(230V50HZ)<sup>2)</sup></b> 278061	
	7	2.2	3	3.5	1	2.2	2.9	<b>DIULM7/21(24VDC)<sup>2)</sup></b> 107021	
	9	2.5	4	4.5	1.5	2.5	3.6	<b>DIULM9/21(230V50HZ)<sup>2)</sup></b> 278086	
	9	2.5	4	4.5	1.5	2.5	3.6	<b>DIULM9/21(24VDC)<sup>2)</sup></b> 107022	
	12	3.5	5.5	6.5	2	3	4.4	<b>DIULM12/21(230V50HZ)<sup>2)</sup></b> 278111	
	12	3.5	5.5	6.5	2	3	4.4	<b>DIULM12/21(24VDC)<sup>2)</sup></b> 107023	
	18	5	7.5	11	2.5	4.5	6.5	<b>DIULM17/21(230V50HZ)<sup>2)</sup></b> 278136	
	18	5	7.5	11	2.5	4.5	6.5	<b>DIULM17/21(RDC24)<sup>2)</sup></b> 107024	
	25	7.5	11	14	3.5	6	8.5	<b>DIULM25/21(230V50HZ)<sup>2)</sup></b> 278161	
	25	7.5	11	14	3.5	6	8.5	<b>DIULM25/21(RDC24)<sup>2)</sup></b> 107025	
	32	10	15	17	4	7	10	<b>DIULM32/21(230V50HZ)<sup>2)</sup></b> 278186	
	32	10	15	17	4	7	10	<b>DIULM32/21(RDC24)<sup>2)</sup></b> 107026	
	40	12.5	18.5	23	5	9	12	<b>DIULM40/11(230V50HZ)<sup>2)</sup></b> 278211	
	50	15.5	22	30	6	10	14	<b>DIULM50/11(230V50HZ)<sup>2)</sup></b> 278236	
	65	20	30	35	7	12	17	<b>DIULM65/11(230V50HZ)<sup>2)</sup></b> 278261	

Information relevant for export to North America



1)  
Product Standards IEC/EN 60947-4-1; UL 508; CSA-C22.2 No. 14-05;  
CE marking  
UL File No. E29096  
UL CCN NLDX  
CSA File No. 012528  
CSA Class No. 3211-04  
NA Certification UL Listed, CSA certified

Information relevant for export to North America



2)  
Product Standards IEC/EN 60947-4-1; UL 508; CSA-C22.2 No. 14-05;  
CE marking  
UL File No. E29096  
UL CCN NLDX  
CSA File No. 012528  
CSA Class No. 2411-03, 3211-04  
NA Certification UL Listed, CSA certified

Individual components of the combination	Spare auxiliary contacts	Circuit diagram		Notes
Contactor Q11	Contactor Q12	Q11	Q12	Mechanical interlock
Part no.	Part no.			
DILEM-10 + 11DILEM	DILEM-10 + 11DILEM			+
DILEM-10-G + 11DILEM	DILEM-10-G + 11DILEM			+
DILM7-01 + DILA-XHI20	DILM7-01 + DILA-XHI20			+
DILM7-01 + DILA-XHI20	DILM7-01 + DILA-XHI20			+
DILM9-01 + DILA-XHI20	DILM9-01 + DILA-XHI20			+
DILM9-01 + DILA-XHI20	DILM9-01 + DILA-XHI20			+
DILM12-01 + DILA-XHI20	DILM12-01 + DILA-XHI20			+
DILM12-01 + DILA-XHI20	DILM12-01 + DILA-XHI20			+
DILM17-01 + DILA-XHI20	DILM17-01 + DILA-XHI20			+
DILM17-01 + DILA-XHI20	DILM17-01 + DILA-XHI20			+
DILM25-01 + DILA-XHI20	DILM25-01 + DILA-XHI20			+
DILM25-01 + DILA-XHI20	DILM25-01 + DILA-XHI20			+
DILM32-01 + DILA-XHI20	DILM32-01 + DILA-XHI20			+
DILM32-01 + DILA-XHI20	DILM32-01 + DILA-XHI20			+
DILM40 + DILM150-XHI11	DILM40 + DILM150-XHI11	-	-	+
DILM50 + DILM150-XHI11	DILM50 + DILM150-XHI11	-	-	+
DILM65 + DILM150-XHI11	DILM65 + DILM150-XHI11	-	-	+

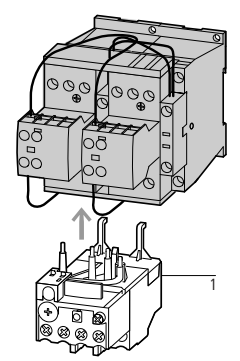
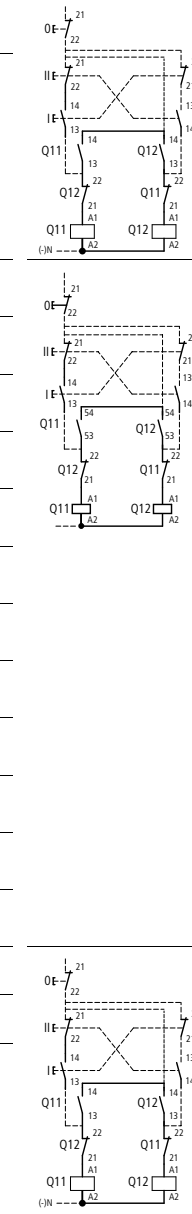



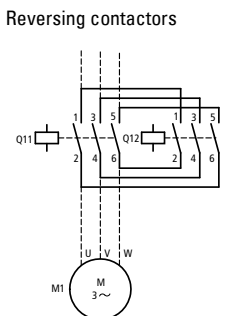





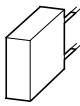
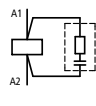

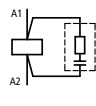

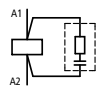

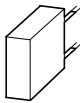
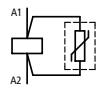
**Accessories**  
1 Overload relay  
Accessories  
Page → 6/8  
→ 5/56

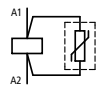

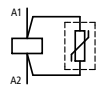
DIULM7/21 to DIULM65/11 with mechanical interlock

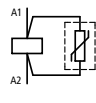
## Ordering

Voltage $U_s$ V	For use with	Circuit symbol	Part no. Article no.	Price See price list	Std. pack	Notes	
<b>Suppressor circuits</b>							
<b>RC suppressors</b>							
	24 - 48 AC		<b>DILM12-XSPR48</b> 281199		<b>10 Off</b>  	For AC operated contactors 50 - 60 Hz. DC operated contactors and DILM115 and DILM150 have an integrated suppressor. Note drop-out delay.	
	110 - 240 AC		<b>DILM12-XSPR240</b> 281200				
	240 - 500 AC		<b>DILM12-XSPR500</b> 281201				
	24 - 48 AC		<b>DILM32-XSPR48</b> 281202		<b>10 Off</b>  		
	110 - 240 AC		<b>DILM32-XSPR240</b> 281203				
	240 - 500 AC		<b>DILM32-XSPR500</b> 281204				
	24 - 48 AC		<b>DILM95-XSPR48</b> 281205		<b>10 Off</b>  		
	110 - 240 AC		<b>DILM95-XSPR240</b> 281206				
	240 - 500 AC		<b>DILM95-XSPR500</b> 281207				
<b>Varistor suppressors</b>							
	24 - 48 AC		<b>DILM12-XSPV48</b> 281208		<b>10 Off</b>  		For AC operated contactors 50 - 60 Hz. DC operated contactors and DILM115 and DILM150 have an integrated suppressor. Note drop-out delay.
	48 - 130 AC		<b>DILM12-XSPV130</b> 281209				
	130 - 240 AC		<b>DILM12-XSPV240</b> 281210				
	240 - 500 AC		<b>DILM12-XSPV500</b> 281211		<b>10 Off</b>  		
	24 - 48 AC		<b>DILM32-XSPV48</b> 281212				
	48 - 130 AC		<b>DILM32-XSPV130</b> 281213				
	130 - 240 AC		<b>DILM32-XSPV240</b> 281214		<b>10 Off</b>  		
	240 - 500 AC		<b>DILM32-XSPV500</b> 281215				
	24 - 48 AC		<b>DILM95-XSPV48</b> 281216				
	48 - 130 AC		<b>DILM95-XSPV130</b> 281217		<b>10 Off</b>  		
	130 - 240 AC		<b>DILM95-XSPV240</b> 281218				
	240 - 500 AC		<b>DILM95-XSPV500</b> 281219				





## Information relevant for export to North America

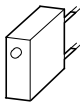
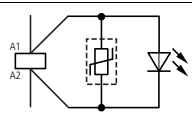

Product Standards	IEC/EN 60947-4-1; UL 508; CSA-C22.2 No. 14-05; CE marking
UL File No.	E29096
UL CCN	NLDX
CSA File No.	227038
CSA Class No.	3211-07
NA Certification	UL Listed, CSA certified

HPL05055EN

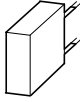
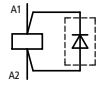





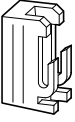

**DILM...-XSP...**

Voltage $U_s$ V	For use with	Circuit symbol	Part no. Article no.	Price See price list	Std. pack	Notes
<b>Varistor suppressors with integrated LED</b>						
 24 - 48 AC 130 - 240 AC	DILM7 - DILM15 DILMP20 DILA		<b>DILM12-XSPVL48</b> 281220		10 Off 	For AC operated contactors 50 - 60 Hz. DC operated contactors and DILM115 and DILM150 have an integrated suppressor. Note drop-out delay.
				<b>DILM12-XSPVL240</b> 281221		
24 - 48 AC 130 - 240 AC	DILM17 - DILM32 DILK12 - DILK25 DILL... DILMP32 - DILMP45		<b>DILM32-XSPVL48</b> 281222			
			<b>DILM32-XSPVL240</b> 281223			
24 - 48 AC 130 - 240 AC	DILM40 - DILM95 DILK33 - DILK50 DILMP63 - DILMP200		<b>DILM95-XSPVL48</b> 281224			
			<b>DILM95-XSPVL240</b> 281225			
<b>Diode suppressor</b>						
 12 - 250 DC	DILM7 - DILM15 DILMP20 DILA		<b>DILM12-XSPD</b> 101672		10 Off 	Additional for integrated suppressor with DC operated contactors. Prevention of negative switch-off voltage when the contactor is used together with a safety PLC.

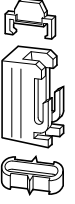
**Information relevant for export to North America**



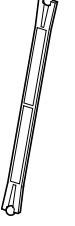
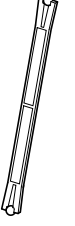
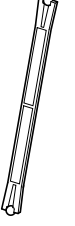
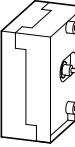
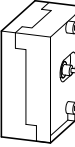

















Product Standards	IEC/EN 60947-4-1; UL 508; CSA-C22.2 No. 14-05; CE marking
UL File No.	E29096
UL CCN	NLDX
CSA File No.	227038
CSA Class No.	3211-07
NA Certification	UL Listed, CSA certified

For use with	Part no.	Price See price list	Std. pack	Notes	Information relevant for export to North America 
<b>Mechanical interlocks</b>					
For mechanically linking contactors in combinations 0 mm distance between contactors.					
	DILM7 - DILM72 DILA	<b>DILM32-XVB</b> 281227	50 Off 	-	Product Standards IEC/EN 60947-4-1; UL 508; CSA-C22.2 No. 14-05; CE marking UL File No. E36332 UL CCN NLRV CSA File No. 012528 CSA Class No. 3211-05 NA Certification UL Recognized, CSA certified
	DILM80 - DILM170	<b>DILM150-XVB</b> 281226	10 Off 	-	Product Standards IEC/EN 60947-4-1; UL 508; CSA-C22.2 No. 14-05; CE marking UL File No. E29184 UL CCN NKCR CSA File No. 012528 CSA Class No. 3211-03 NA Certification UL Listed, CSA certified
<b>Mechanical interlocks</b>					
	DILM7 - DILM15 DILMP20 DILA	<b>DILM12-XMV</b> 281196	1 Off 	For two contactors with AC or DC operation arranged vertically or horizontally. Distance between contactors 0 mm, including contactor connector Mechanical lifespan 2.5 x 10 <sup>6</sup> operations. DILM 150-XMV including mounting plate for contactors. Additional auxiliary contact modules possible. → 5/38	Product Standards IEC/EN 60947-4-1; UL 508; CSA-C22.2 No. 14-05; CE marking UL File No. E29096 UL CCN NLDX CSA File No. 012528 CSA Class No. 2411-03 NA Certification UL Listed, CSA certified
	DILM17 - DILM38	<b>DILM32-XMV</b> 281197			Product Standards IEC/EN 60947-4-1; UL 508; CSA-C22.2 No. 14-05; CE marking UL File No. E29096 UL CCN NLDX CSA File No. 012528 CSA Class No. 2411-03, 3211-04 NA Certification UL Listed, CSA certified
	DILM40 - DILM72	<b>DILM65-XMV</b> 281198			Product Standards IEC/EN 60947-4-1; UL 508; CSA-C22.2 No. 14-05; CE marking UL File No. E29096 UL CCN NLDX CSA File No. 012528 CSA Class No. 2411-03, 3211-04 NA Certification UL Listed, CSA certified
	DILM80 - DILM170	<b>DILM150-XMV</b> 240081			Product Standards IEC/EN 60947-4-1; UL 508; CSA-C22.2 No. 14-05; CE marking UL File No. E29096 UL CCN NLDX CSA File No. 012528 CSA Class No. 2411-03 NA Certification UL Listed, CSA certified
	DILM185A, DILM225A, DILM250, DILM300A, DILM400, DILM500, DILM570	<b>DILM500-XMV</b> 208289			For contactors with the same or different magnet systems mounted horizontally or vertically, mechanical lifespan 5 x 10 <sup>6</sup> operations. <b>No</b> auxiliary contact permitted between mechanical interlock and contactor. Combination only with consecutive installation sizes or DILM185A - DILM570.
	DILM580, DILM650, DILM750, DILM820 DILM1000	<b>DILM820-XMV</b> 208288	For contactors with the same or different magnet systems mounted horizontally or vertically, mechanical lifespan 5 x 10 <sup>6</sup> operations. <b>No</b> auxiliary contact permitted between mechanical interlock and contactor. DILM820-XMV consists of interlock element and mounting plate.	Product Standards IEC/EN 60947-4-1; UL 508; CSA-C22.2 No. 14-05; CE marking UL File No. E29184 UL CCN NKCR CSA File No. 012528 CSA Class No. 3211-04 NA Certification UL Listed, CSA certified	
<b>Set of spare parts for mechanical interlock</b>					
Ball for mechanical interlock, incl. contactor connector.					
-	DILM80 - DILM170	<b>DILM150-XMVE</b> 107020	1 Off 	-	UL/CSA certification not required





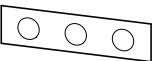



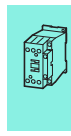

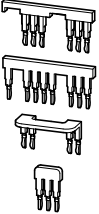

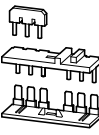



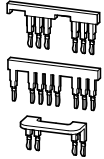

**DILM...-XP1, DILM...-XS1**

HPL05057EN

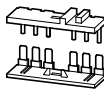
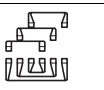

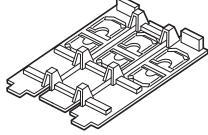





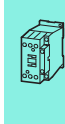



For use with	Circuit symbol	Part no.	Price See price list	Std. pack	Notes	Information relevant for export to North America
<b>Paralleling links for main contacts</b>						
Consisting of 2 paralleling links						
	DILM7 - DILM15		<b>DILM12-XP1</b> 281193	5 Off 	4th pole can be broken off AC-1 current carrying capacity of the open contactor increases by a factor of 2.5 Protected against accidental contact in accordance with VDE 0106 Part 100 A cover is included with DILM185-XP1 for protection against accidental contact. Connection cross section for DILM.-XP1 Technical data	Product Standards IEC/EN 60947-4-1; UL 508; CSA-C22.2 No. 14-05; CE marking E29096 NLDX 012528 3211-03 UL Listed, CSA certified  UL File No. UL CCN CSA File No. CSA Class No. NA Certification
	DILM17 - DILM32		<b>DILM32-XP1</b> 281194			
	DILM40 - DILM72		<b>DILM65-XP1</b> 281195	1 Off 		
	DILM80 - DILM170		<b>DILM150-XP1</b> 284769			
	DILM185A		<b>DILM185-XP1</b> 208292	1 Off		
<b>Star-point bridges</b>						
	DILM7 - DILM15		<b>DILM12-XS1</b> 281190	20 Off 	<ul style="list-style-type: none"> <li>Designed as tool-less plug connection</li> <li>Use as DILA-XHIT... contactor auxiliary contact → 5/40</li> </ul>	Product Standards IEC/EN 60947-4-1; UL 508; CSA-C22.2 No. 14-05; CE marking E36332 NLRV 012528 3211-05 UL Listed, CSA certified  UL File No. UL CCN CSA File No. CSA Class No. NA Certification
	DILM17 - DILM32		<b>DILM32-XS1</b> 281191			
	DILM40 - DILM72		<b>DILM65-XS1</b> 281192	10 Off 	-	UL File No. UL CCN CSA File No. CSA Class No. NA Certification
	DILM80 - DILM170		<b>DILM150-XS1</b> 284768	5 Off 	-	Product Standards IEC/EN 60947-4-1; UL 508; CSA-C22.2 No. 14-05; CE marking E36332 NLRV 012528 3211-03 UL Listed, CSA certified  UL File No. UL CCN CSA File No. CSA Class No. NA Certification
	DILM185A - DILM400		<b>DILM400-XS1</b> 208291	1 Off 	A cover is included for protection against accidental contact.	Product Standards IEC/EN 60947-4-1; UL 508; CSA-C22.2 No. 14-05; CE marking E36332 NLRV 012528 3211-04 UL Listed  UL File No. UL CCN CSA File No. CSA Class No. NA Certification
	DILM500		<b>DILM500-XS1</b> 208290		A cover is included for protection against accidental contact.	Product Standards IEC/EN 60947-4-1; UL 508; CSA-C22.2 No. 14-05; CE marking E29096 NLDX UL Listed  UL File No. UL CCN NA Certification







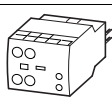
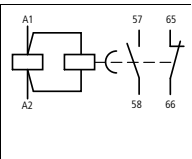

For use with	Part no.	Price See price list	Std. pack	Notes	Information relevant for export to North America 
<b>Star-delta wiring kit</b>					
Main current wiring for star-delta combination Including star-point bridge					
	DILM7/9/12/15 mains contactors DILM7/9/12/15 delta contactors DILM7/9/12/15 star contactors	<b>DILM12-XSL</b> 283130	1 Off 	<ul style="list-style-type: none"> <li>Designed for tool-less plug connection</li> <li>Use as DILA-XHIT... contactor auxiliary contact → 5/40</li> </ul> The following control cables are integrated in addition to electrical interlock: <ul style="list-style-type: none"> <li>Q13: A1 - Q15: 21</li> <li>Q13: 21 - Q15: A1</li> <li>Q13: A2 - Q15: A2</li> </ul>	Product Standards IEC/EN 60947-4-1; UL 508; CSA-C22.2 No. 14-05; CE marking 012528 3211-05 CSA certified  CSA File No. CSA Class No. NA Certification
	DILM17/25/32 mains contactors DILM17/25/32 delta contactors DILM17/25/32 star contactors	<b>DILM32-XSL</b> 283131		Consists of the following connection bridges: <ul style="list-style-type: none"> <li>Mains - delta contactors</li> <li>Delta - star contactors</li> <li>Star-point bridge</li> </ul>	Product Standards IEC/EN 60947-4-1; UL 508; CSA-C22.2 No. 14-05; CE marking E36332 NLRV 012528 3211-04 UL Listed, CSA certified  UL File No. UL CCN CSA File No. CSA Class No. NA Certification
	DILM40/50/65 mains contactors DILM40/50/65 delta contactors DILM40/50/65 star contactors	<b>DILM65-XSL</b> 101058			
	DILM 80/95 mains contactors DILM80/95 delta contactors DILM50/65 star contactors	<b>DILM95-XSL</b> 101486	1 Off		-
	DILM 115/150 mains contactors DILM115/150 delta contactors DILM80/95/115 star contactors	<b>DILM150-XSL</b> 101487	1 Off 		Product Standards IEC/EN 60947-4-1; UL 508; CSA-C22.2 No. 14-05; CE marking E36332 NLRV 012528 2411-03, 3211-04 UL Listed, CSA certified  UL File No. UL CCN CSA File No. CSA Class No. NA Certification
	DILM 185/225 mains contactors DILM185/225 delta contactors DILM115/150 star contactors	<b>DILM225-XSL</b> 101488	1 Off		-

For use with	Part no.	Price See price list	Std. pack	Notes	Information relevant for export to North America 
<b>Reversing starter wiring kits</b>					
<b>Main current wiring for reversing combinations</b>					
	DILM7 DILM9 DILM12	<b>DILM12-XRL</b> 283108	1 Off 	<ul style="list-style-type: none"> <li>Designed for tool-less plug connection</li> <li>As auxiliary contact DILA-XHIT...use → 5/40</li> </ul> The following control cables are integrated in addition to electrical interlock: <ul style="list-style-type: none"> <li>Q11: A1 - Q12: 21</li> <li>Q11: 21 - Q12: A1</li> <li>Q11: A2 - Q12: A2</li> </ul>	Product Standards IEC/EN60947-4-1; UL 508; CSA-C22.2 No. 14-05; CE marking E36332 UL File No. NLRV UL CCN 012528 CSA File No. 3211-05 CSA Class No. UL Listed, CSA certified NA Certification
	DILM17 DILM25 DILM32	<b>DILM32-XRL</b> 283109	-	-	Product Standards IEC/EN60947-4-1; UL 508; CSA-C22.2 No. 14-05; CE marking E36332 UL File No. NLRV UL CCN 012528 CSA File No. 3211-04 CSA Class No. UL Listed, CSA certified NA Certification
	DILM40 DILM50 DILM65	<b>DILM65-XRL</b> 101057	-	-	Product Standards IEC/EN60947-4-1; UL 508; CSA-C22.2 No. 14-05; CE marking E36332 UL File No. NLRV UL CCN 012528 CSA File No. 2411-03, 3211-04 CSA Class No. UL Listed, CSA certified NA Certification
	DILM80 DILM95 DILM115 DILM150	<b>DILM150-XRL</b> 101681	-	-	Product Standards IEC/EN60947-4-1; UL 508; CSA-C22.2 No. 14-05; CE marking E36332 UL File No. NLRV UL CCN 012528 CSA File No. 2411-03, 3211-04 CSA Class No. UL Listed, CSA certified NA Certification
<b>IP2X cover set</b>					
	DILM17 DILM25 DILM32 DILM38 DILMP32 DILMP45	<b>DILM32-XIP2X</b> 118855	1 Off 	Each cover set consists of two three-pole and two single-pole covers.	UL/CSA certification not required
	DILM40 DILM50 DILM65 DILM72 DILMP63 DILMP80	<b>DILM65-XIP2X</b> 106491	8 Off 	2 covers are required per phase The cover set consists of 8 covers	UL/CSA certification not required
	DILM80 DILM95 DILM115 DILM150 DILM170 DILMP125 DILMP160 DILMP200 ZB150	<b>DILM150-XIP2X</b> 106492	-	-	UL/CSA certification not required

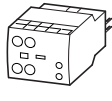
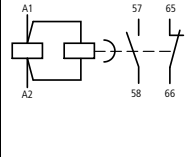

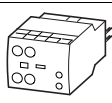
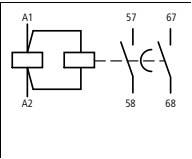
For use with	Part no.	Price See price list	Std. pack	Notes	Information relevant for export to North America  
<b>Three-phase commoning links</b>					
Protected against accidental contact, short-circuit proof, $U_e = 690\text{ V}$ , $I_u = 35\text{ A}$ Can be extended by rotating by mounting					
	DILM7 DILM9 DILM12 DILM15	<b>DILM12-XDSB0/3</b> 240084	5 Off  	Suitable for 3 contactors. Length 112 mm	Product Standards IEC/EN 60947-4-1; UL 508; CSA-C22.2 No. 14-05; CE marking E36332 UL File No. NLRV UL CCN 012528 CSA File No. 2411-03 CSA Class No. UL Listed, NA Certification CSA certified
	DILM7 DILM9 DILM12 DILM15	<b>DILM12-XDSB0/4</b> 240085		Suitable for 4 contactors. Length 157 mm	
	DILM7 DILM9 DILM12 DILM15	<b>DILM12-XDSB0/5</b> 240086		Suitable for 5 contactors. Length 202 mm	
<b>Incoming connection block</b>					
–	DILM7 DILM9 DILM12 DILM15	<b>DILM12-XEK</b> 240083	5 Off  	For three-phase commoning link, protected against accidental contact, $U_e = 690\text{ V}$ , $I_u = 35\text{ A}$ . Terminal capacities: Stranded 2.5...16 mm <sup>2</sup> Flexible with ferrule 2.5...16 mm <sup>2</sup> AWG14...8	Product Standards IEC/EN 60947-4-1; UL 508; CSA-C22.2 No. 14-05; CE marking E36332 UL File No. NLRV UL CCN 012528 CSA File No. 2411-03 CSA Class No. UL Listed, NA Certification CSA certified
<b>Adapter plate</b>					
Enables clipping on of switches on to DIN rails					
	DILM80 DILM95 DILM115 DILM150 DILM170	<b>NZM2-XC75</b> 260215	1 Off  	For top-hat rail 75 mm	Product Standards UL489; CSA-C22.2 No. 5-09; IEC60947, CE marking E140305 UL File No. DIHS UL CCN 022086 CSA File No. 1437-01 CSA Class No. UL Listed, NA Certification CSA certified

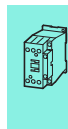

For use with	Circuit symbol	Part no. Article no.	Price See price list	Std. pack	Notes
<b>Electronic timer modules</b>					
<b>On-delayed</b> Cannot be combined with top mounting auxiliary contacts Incl. suppressor circuits					
 24 V AC/DC 100 ... 130 V AC 200 ... 240 V AC	DILM7 - DILM32 DILMP20 DILMP32-DILMP45 DILA 	DILM32-XTEE11(RA24) 101440		1 Off 	Time range can be selected 0.05 s...1 s 0.5 s...10 s 5 s...100 s
		DILM32-XTEE11(RAC130) 101441			
		DILM32-XTEE11(RAC240) 101442			
<b>Off-delayed, auxiliary voltage-free</b> Cannot be combined with top mounting auxiliary contacts Incl. suppressor circuits					
 24 V AC/DC 100 ... 130 V AC 200 ... 240 V AC	DILM7 - DILM32 DILMP20 DILMP32-DILMP45 DILA 	DILM32-XTED11-1(RA24) 105210		1 Off 	Time range 0.05 s...1 s
		DILM32-XTED11-10(RA24) 104943			Time range 0.5 s...10 s
		DILM32-XTED11-100(RA24) 104946			Time range 5 s...100 s
		DILM32-XTED11-1(RAC130) 105211			Time range 0.05 s...1 s
		DILM32-XTED11-10(RAC130) 104944			Time range 0.5 s...10 s
		DILM32-XTED11-100(RAC130) 104947			Time range 5 s...100 s
		DILM32-XTED11-1(RAC240) 105212			Time range 0.05 s...1 s
		DILM32-XTED11-10(RAC240) 104945			Time range 0.5 s...10 s
		DILM32-XTED11-100(RAC240) 104948			Time range 5 s...100 s
		<b>For star-delta applications</b> Cannot be combined with top mounting auxiliary contacts Incl. suppressor circuits			
 24 V AC/DC 100 ... 130 V AC 200 ... 240 V AC	DILM7 - DILM32 DILMP20 DILMP32-DILMP45 DILA 	DILM32-XTEY20(RA24) 101446		1 Off 	Changeover time 1...30 s 50 ms changeover delay Sample circuit → Page 5/96
		DILM32-XTEY20(RAC130) 101447			
		DILM32-XTEY20(RAC240) 101448			







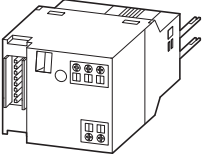

#### Information relevant for export to North America

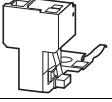

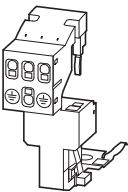





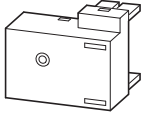

Product Standards	IEC/EN 60947-4-1; UL 508; CSA-C22.2 No. 14-05; CE marking
UL File No.	E29184
UL CCN	NKCR
CSA File No.	012528
CSA Class No.	3211-03
NA Certification	UL Listed, CSA certified

	For use with	Part no. Article no.	Price See price list	Std. pack	Notes
<b>SWD contactor modules</b>					
<b>SmartWire-Darwin module for installation on contactors. One module per contactor</b>					
	Two digital inputs for potential-free contacts. 1 electrical interlock for the surface mounting of reversing starters. Messages: Contactor switch status, status of the digital inputs 1 and 2. Commands: Contactor actuation	DILM(C)7... - DILM(C)32 DILM38 DILA	<b>DIL-SWD-32-001<sup>1)</sup></b> 118560	5 Off 	<ul style="list-style-type: none"> <li>Take into account the max. current consumption of the contactor coils per SmartWire-Darwin line.</li> <li>A2 terminals must not be bridged.</li> <li>Wiring sets DILM 12-XRL and PKZM0-XRM12 cannot be used.</li> <li>Connection terminals for electrical interlocking are not suitable for safety technology.</li> </ul>
	Two digital inputs for potential-free contacts. 1 electrical interlock for the surface mounting of reversing starters. 1-0-A switch for manual or automatic operation. Messages: contactor switching position, status of the digital inputs 1 and 2, 1-0-A switch position. Commands: Contactor actuation	DILM(C)7... - DILM(C)32 DILM38 DILA	<b>DIL-SWD-32-002<sup>1)</sup></b> 118561	5 Off 	

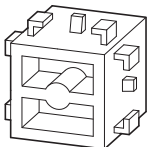
	For use with	Part no. Article no.	Price See price list	Std. pack	Notes
<b>Wiring set for motor feeder plug</b>					
	DILM(C)7 DILM(C)9 DILM(C)12 DILM(C)15	<b>DILM12-XMCE<sup>2)</sup></b> 121764		5 Off 	35x7.5 (15) mm mounting rail (as per DIN EN 60715) with PE function required. For connection of: PE 0.75 – 4 mm <sup>2</sup>
	DILM(C)7 DILM(C)9 DILM(C)12 DILM(C)15	<b>DILM12-XMCP/E<sup>2)</sup></b> 121769		1 Off 	35x7.5 (15) mm mounting rail (as per DIN EN 60715) with PE function required. For connection of: L1, L2, L3, PE 0.75 – 2.5 mm <sup>2</sup>
	PKZM0/PKE + DILM(C)7 PKZM0/PKE + DILM(C)9 PKZM0/PKE + DILM(C)12 PKZM0/PKE + DILM(C)15 MSC-D(E)-...-M7... MSC-D(E)-...-M9... MSC-D(E)-...-M15...	<b>DILM12-XMCP/T<sup>2)</sup></b> 121770		1 Off 	For connection of: L1, L2, L3, PE 0.75 – 2.5 mm <sup>2</sup>

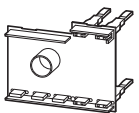
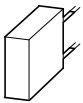
**Information relevant for export to North America**

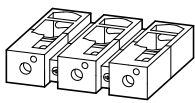
- 1) NA Certification Request filed for UL and CSA  
 2) Product Standards IEC/EN 60947-4-1; UL 508; CSA-C22.2 No. 14-05; CE marking  
 NA Certification Request filed for UL and CSA

For use with	Part no. Article no.	Price See price list	Std. pack	Notes	Information relevant for export to North America 	
<b>Motor suppressor module</b>						
Can be used at 380...575 V 50/60 Hz.						
	DILM7 - DILM15	<b>DILM12-XMSM</b> 109399	4 Off 	<ul style="list-style-type: none"> <li>• Tool-less version using tool-less plug connection</li> <li>• RC suppressor</li> <li>• Ambient temperature -25...+60 °C, open.</li> <li>• Insulated material, difficult to ignite according to UL 94.</li> <li>• Weight = 0.05 kg.</li> <li>• UL/CSA approval applied for</li> </ul>	Product Standards UL File No. UL CCN NA Certification	IEC/EN 60947-4-1; UL 508; CE marking E300273 NMTR2 UL Recognized
<b>Test block</b>						
Suitable for switching on contactor off-load						
	DILM7 - DILM38 DILA	<b>DILM32-XMAN</b> 110955	1 Off 	-	UL/CSA certification not required	
<b>Printed board contact</b>						
For the adaption of a control circuit on a printed-circuit board						
	DILM7 - DILM15 DILA	<b>DILM12-XPBC</b> 109400	4 Off	-	-	
<b>Load resistor</b>						
For DC contactors in order to increase power consumption						
	DILM17 DILM25 DILM32 DILM38 DILMP32 DILMP45	<b>DILM32-XSPLW24</b> 112419	1 Off 	Installed in a suppressor circuit enclosure. Required when using special PLC outputs for actuation, e.g.: Beckhoff safety controllers.	Product Standards CSA File No. CSA Class No. NA Certification	IEC/EN 60947-4-1; CSA-C22.2 No. 14-05; CE marking 225135 3211-07 CSA certified
<b>Extension terminals</b>						
	DILM80 DILM95 DILM115 DILM150 DILM170	<b>DILM150-XZK</b> 104486	10 Off 	Can be fitted on every main terminal of the contactor. Connection options: maximum 2 x 4 mm <sup>2</sup> solid maximum 2 x 2.5 mm <sup>2</sup> flexible with ferrule	Product Standards UL File No. UL CCN CSA File No. CSA Class No. NA Certification	IEC/EN 60947-4-1; UL 508; CSA-C22.2 No. 14-05; CE marking E29184 NKCR 012528 2411-03, 2411-04 UL Listed, CSA certified
<b>Cable terminal block</b>						
With control circuit terminal Consisting of three flat ribbon terminals						
	DILM250 DILM300A DILM400	<b>DILM400-XKU-S</b> 208293	1 Off 	Connection options: round conductors, flexible and stranded, ribbon cables.	Product Standards UL File No. UL CCN CSA File No. CSA Class No. NA Certification	IEC/EN 60947-4-1; UL 508; CSA-C22.2 No. 14-05; CE marking E29184 NKCR 012528 3211-04 UL Listed, CSA certified

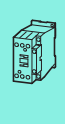

For use with	Part no. Article no.	Price See price list	Std. pack	Notes	Information relevant for export to North America
--------------	-------------------------	-------------------------	-----------	-------	--

**Flat strip conductor terminal kit**

With control cable connection

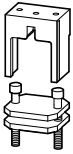

DILM580  
DILM650  
DILM750  
DILM820

**DILM820-XKB-S**  
208295

1 Off

Connection options:  
ribbon cables



Conductor material	Cross-section X number of cores mm <sup>2</sup>	For use with	Part no. Article no.	Price See price list	Std. pack	Notes	Information relevant for export to North America
--------------------	--	--------------	-------------------------	-------------------------	-----------	-------	--

**Connection terminal sets for North America**

Consist of three individual terminals

Copper, aluminum	2 x (AWG4 ... MCM500)	DILM500/22
Copper, aluminum	4 x (AWG2 ... MCM500)	DILM580/22 DILM650/22 DILM750/22 DILM820/22

**DILM500-XK-CNA**  
232192

**DILM820-XK-CNA**  
232194

1 Off













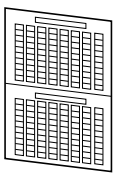

Including cover  
With control  
cable connec-  
tion

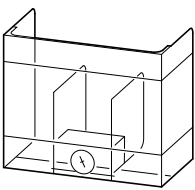
Product Standards	IEC/EN 60947-4-1; UL 508; CSA-C22.2 No. 14-05; CE marking
UL File No.	E29184
UL CCN	NKCR
CSA File No.	012528
CSA Class No.	3211-04
NA Certification	UL Listed, CSA certified

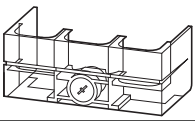

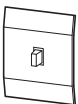
HPL05065EN

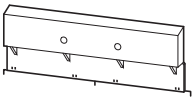
**DILM...-XHB, DILM...-XAB**

Description	For use with	Part no. Article no.	Price See price list	Std. pack	Notes	Information relevant for export to North America 
<b>Sealable shrouds</b>						
Transparent 	DILM32-XTE...	<b>DILM32-XTEPLH</b> 101449		1 Off	-	-
<b>Device labelling, label sheet</b>						
7.5 x 17 mm Colour: yellow HKS 3 (≈RAL 1018) 	Labelling with laser printer, plotter, film plotter, copier	<b>XGKE-GE</b> 207517		25 Off 	1 off = 1 sheet 240 labels per sheet 1 sheet = DIN A4, Can be split into two DIN A5 sheets	UL/CSA certification not required
<b>Covers</b>						
Terminal cover 	DILM185A DILM225A DILM250 DILM300A DILM400 DILM500 DILM580 DILM650 DILM750 DILM820, DILM1000	<b>DILM225A-XHB</b> 139560 <b>DILM400-XHB</b> 208287 <b>DILM500-XHB</b> 208286 <b>DILM650-XHB</b> 208285 <b>DILM820-XHB</b> 208284		1 Off 	To provide terminals with protection against accidental contact vertical from the front	UL/CSA certification not required
Shroud for star-point bridge 	DILM400-XS1	<b>DILM400-XHBS1</b> 101687		1 Off 	Can be combined with star-delta wiring kits DILM250-XSL and DILM400-XSL.	UL/CSA certification not required
Auxiliary contact seat cover  	DILM7 - DILM38 DILMP32 DILMP45 DILA DILL DILM40 - DILM170 DILMP63 - DILMP200	<b>DILM32-XAB</b> 129538 <b>DILM150-XAB</b> 121712		10 Off 	For preventing manual actuation. Cannot be combined with additional surface mounting accessories.	UL/CSA certification not required
Suppressor circuits for vacuum contactors (on load side) 	DILM580 DILM650 DILM750 DILM820 DILM1000 DILH2000 DILH2200 DILH2600	<b>DILM1000-XSM</b> 125947 <b>DILH2600-XSM</b> 125946		1 Off 	For damping the cutout overvoltage when switching off inductive loads.	NA Certification Request filed for UL and CSA

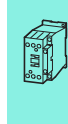

Rated operational current			Actuating voltage	Actuating current	Circuit symbol	For use with	Part no.	Price	Std. pack	Information relevant for export to North America
AC-15		DC						See price list		
230 V	400 V	220 V								
$I_e$	$I_e$	$I_e$	$U_s$	$I$						
A	A	A	V DC	mA						

**Amplifier module for separate mounting**

Input with integrated suppressor circuit for overvoltage limitation



	2	2	0.03	24	25		...DILM DIMLP... DILL... DILK...	<b>ETS4-VS3</b> 083094	1 Off	Product Standards	IEC/EN 60947-4-1; UL 508; CSA-C22.2 No. 14-05; CE marking
										UL File No.	E29184
										UL CCN	NKCR
										CSA File No.	012528
										CSA Class No.	2411-03, 3211-04
										NA Certification	UL Listed, CSA certified

**Notes** Contactor coils with rated operational current > 2 A must be actuated via the DILER-G mini contactor relay.  
Rated operational current DC:  
Making and breaking conditions DC-13, time L/R 300ms

For use with	DC voltage	Prices	AC voltage	Price	Std. pack	Notes
	Part no.	See price list	Part no.	See price list		
	Article no.		Article no.			
	DILM17 DILM25 DILM32 DILM38	<b>DILM32-XSP(RDC24)</b> <sup>1)</sup> 281155	<b>DILM32-XSP(230V50HZ,240V60HZ)</b> 281141		1 Off	For additional actuating voltages → Page 5/79
	DILM40 DILM50 DILM65 DILM72	<b>DILM65-XSP(RDC24)</b> <sup>1)</sup> 281185	<b>DILM65-XSP(230V50HZ,240V60HZ)</b> 281171			
	DILM80 DILM95	<b>DILM95-XSP(RDC24)</b> <sup>1)</sup> 230080	<b>DILM95-XSP(230V50HZ,240V60HZ)</b> 230062			
	DILM115 DILM150 DILM170	<b>DILM150-XSP(RDC24)</b> <sup>1)</sup> 230115	<b>DILM150-XSP(RAC240)</b> <sup>1)</sup> 230112			
	DILM185A DILM225A	<b>DILM225A-XSP(RDC24)</b> <sup>1)</sup> 139568	<b>DILM225A-XSP(RAC240)</b> <sup>1)</sup> 139565			

**Notes** <sup>1)</sup> Incl. electronic module **Information relevant for export to North America**

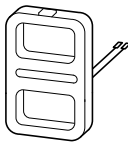
Product Standards	IEC/EN 60947-4-1; UL 508; CSA-C22.2 No. 14-05; CE marking
UL File No.	E29096
UL CCN	NLDX
CSA File No.	012528
CSA Class No.	2411-03, 3211-04
NA Certification	UL Listed, CSA certified

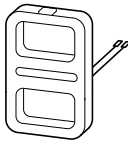
For use with	DC voltage		AC voltage		Std. pack	Notes
	Part no. Article no.	Price See price list	Part no. Article no.	Price See price list		
<b>Electronic modules including coils</b>						
	DILM250 DILM300A	<b>DILM250-XSP/E(RA250)</b> <sup>1)</sup> 208252	<b>DILM250-XSP/E(RA250)</b> <sup>1)</sup> 208252		1 Off 	For additional actuating voltages → Page 5/81
	DILM400 DILM500	<b>DILM500-XSP/E(RA250)</b> <sup>1)</sup> 208256	<b>DILM500-XSP/E(RA250)</b> <sup>1)</sup> 208256			
	DILM580 DILM650 DILM750 DILM820 DILM1000	<b>DILM1000-XSP/E(RA250)</b> <sup>1)</sup> 289145	<b>DILM1000-XSP/E(RA250)</b> <sup>1)</sup> 289145			
	DILH1400	–	<b>DILH1400-XSP/E(RAW250)</b> <sup>2)</sup> 289161			
	DILM250-S DILM300A-S	–	<b>DILM250-S-XSP/E(220-240V50/60HZ)</b> <sup>2)</sup> 274202			
	DILM400-S DILM500-S	–	<b>DILM500-S-XSP/E(220-240V50/60HZ)</b> <sup>2)</sup> 274205			

1)

2)

**Information relevant for export to North America**



Product Standards IEC/EN 60947-4-1; UL 508; CSA-C22.2 No. 14-05;  
CE marking  
UL File No. E29096  
UL CCN NLDX  
CSA File No. 1017510  
CSA Class No. 3211-04  
NA Certification UL Listed, CSA certified

**Information relevant for export to North America**



Product Standards IEC/EN 60947-4-1; UL 508; CSA-C22.2 No. 14-05;  
CE marking  
UL File No. E29096  
UL CCN NLDX  
CSA File No. 012528  
CSA Class No. 3211-04  
NA Certification UL Listed, CSA certified

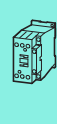

**CMD**

**Description, ordering**

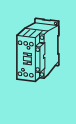

**General**

For safety-related off switching to safety category 3 and 4 according to EN 954-1, at present two contactors must be used in series. Especially with larger contactors this is an expensive solution.

**Application**

This is where the CMD can be used. The function of the CMD is to monitor the main contacts of a contactor against welding. For this the control voltage of the contactor is compared with the state of the main contacts which is reliably monitored using a mirror contact (IEC EN 60947-4-1 Annex F). If the coil is de-energized and the contactor does not drop out the CMD trips the upstream circuit-breaker/motor protective circuit breaker/switch-disconnector via a shunt release.

**Safety**

The CMD has a safety-compliant design so that in safety combinations with a circuit-breaker/motor protective circuit breaker/switch disconnector the reliable switch off in the case of a "welded contactor" can be guaranteed. In this application it replaces the series connection of a second contactor. As a component it conforms to safety category 3 according to EN 954-1 and EN ISO 13849.

**Mounting**

The CMD can be combined with the following Eaton components:

- Contactors:
  - DILEM
  - DILM7 to DILM150
  - DILM185(-S) to DILM500(-S):
  - DILM580 to DILM1600
  - DILH1400 ... DILH2000
  - SE-1A-PKZ2 and S-PKZ2
- Motor-protective circuit-breakers/ circuit-breakers:
  - PKZ2 + U-PKZ2(18VDC)
  - NZM1 + NZM1-XUVL
  - NZM2 + NZM2/3-XUV
  - NZM3 + NZM2/3-XUV
  - NZM4 + NZM4-XUV
  - N1 + NZM1-XUVL
  - N2 + NZM2/3-XUV
  - N3 + NZM2/3-XUV
  - N4 + NZM4-XUV

For the wiring of the CMD the auxiliary N/C contact, mirror contact must be according to IEC/EN 60947-4-1 and the auxiliary N/O contact must be interlocked and opposing according to IEC/EN 60947-5-1. Also the auxiliary N/C contact for the feedback circuit must have a mirror contact function according to IEC/EN 60947-4-1.

Auxiliary contact requirements per contactor:

	CMD	Self maintaining	Feedback circuit	Electrical interlock
DOL starter	1 N/O + 1 N/C	1S	1 B	
Reversing starter	1 N/O + 1 N/C	1S	1 B	1 B

**Ordering**

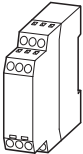
	Part no. Article no.	Price See Price List	Std. pack
CMD contactor monitoring device			
	<b>CMD(24VDC)</b> 106170		1 Off
	<b>CMD(220-240VAC)</b> 106172		1 Off

Engineering

DOL starter

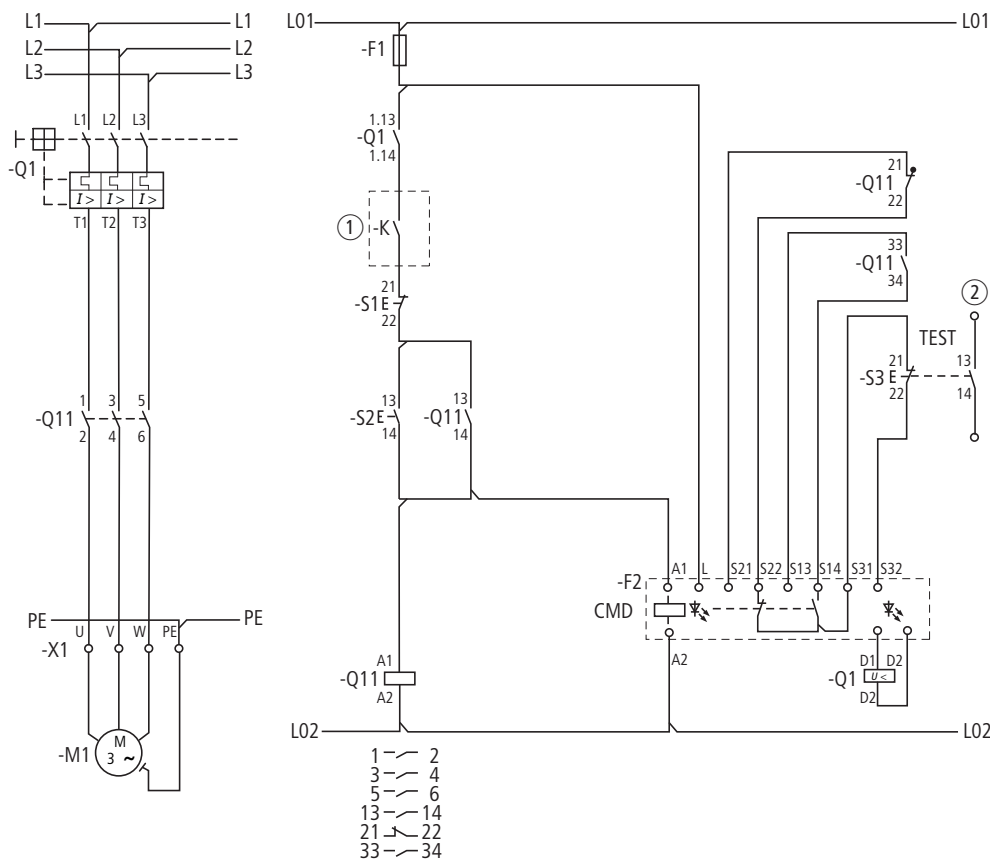

Reversing starter

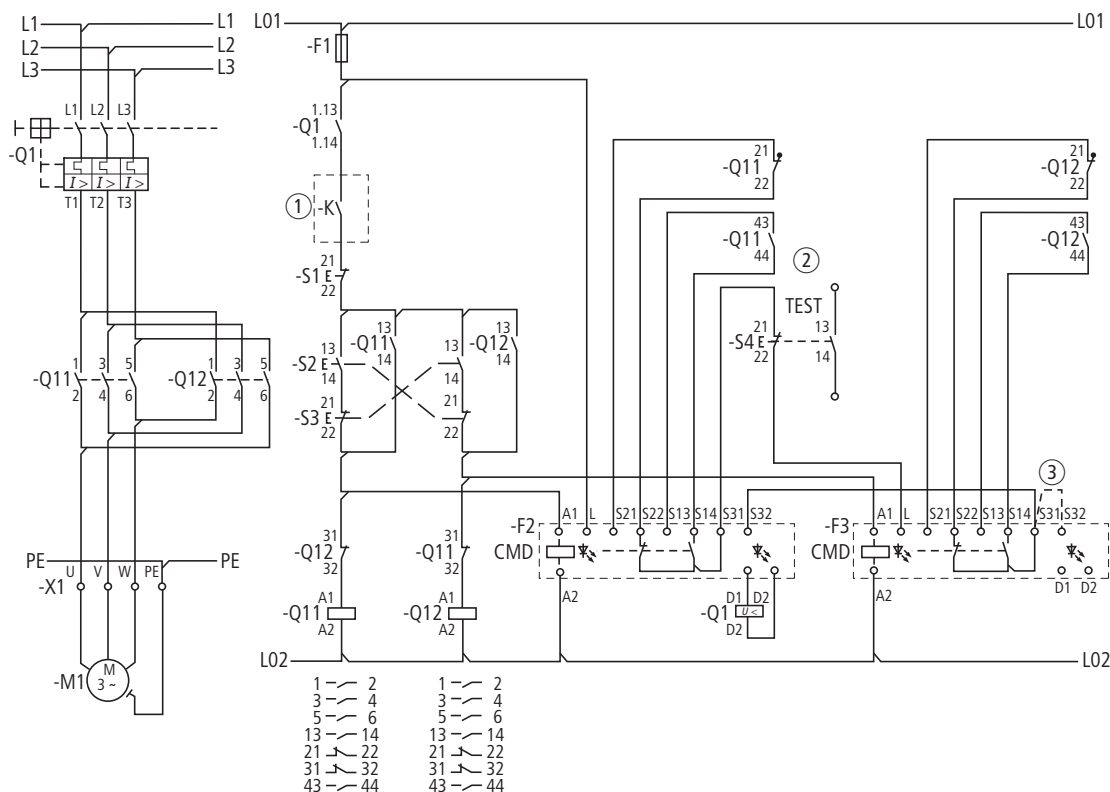

- ① Switching by safety relay of safety PLC
- ② Signal contact to PLC evaluation
- ③ CMD (24VDC)

## Ordering

AC	DILER-40(...)	DILER-31(...)	DILER-22(...)	DILEEM-10(...)	DILEEM-01(...)
	Article no. <sup>1)</sup>	Article no. <sup>1)</sup>	Article no. <sup>1)</sup>	Article no. <sup>1)</sup>	Article no. <sup>1)</sup>
<b>Standard voltages</b>	See price list	See price list	See price list	See price list	See price list
<b>24V 50Hz</b>	010094	010251	010344	051604	051629
<b>48V 50Hz</b>	010190	010044	010201	051603	051628
<b>240V 50Hz</b>	010478	010300	010138	051602	051627
<b>115V 60Hz</b>	010270	010204	010211	051598	051624
<b>42V 50Hz, 48V 60Hz</b>	–	–	–	051612	051637
<b>110V 50Hz, 120V 60Hz</b>	051756	051765	051774	051611	051636
<b>190V 50Hz, 220V 60Hz</b>	051757	051766	051775	051610	051635
<b>220V 50Hz, 240V 60Hz</b>	051758	051767	051776	051609	051634
<b>230V 50Hz, 240V 60Hz</b>	051759	051768	051777	051608	051633
<b>380V 50Hz, 440V 60Hz</b>	051760	051769	051778	051607	051632
<b>400V 50Hz, 440V 60Hz</b>	051761	051770	051779	051606	051631
<b>415V 50Hz, 480V 60Hz</b>	051762	051771	051780	051605	051630
<b>24V 50/60Hz</b>	021924	021594	021704	051596	051621
<b>42V 50/60Hz</b>	033459	029869	029433	051595	051620
<b>110V 50/60Hz</b>	021961	021624	021871	051592	051618
<b>230V 50/60Hz</b>	052725	052509	052508	056674	058771
DC	DILER-40-G(...)	DILER-31-G(...)	DILER-22-G(...)	DILEEM-10-G(...)	DILEEM-01-G(...)
	Article no. <sup>1)</sup>	Article no. <sup>1)</sup>	Article no. <sup>1)</sup>	Article no. <sup>1)</sup>	Article no. <sup>1)</sup>
<b>Standard voltages</b>	See price list	See price list	See price list	See price list	See price list
<b>12V DC</b>	079711	079761	080728	051644	051649
<b>24V DC</b>	010223	010157	010042	051643	051650
<b>48V DC</b>	010255	010205	010346	051642	051648
<b>110V DC</b>	010287	010253	010043	051640	051646
<b>220V DC</b>	010303	010269	010091	051639	051645

## Notes

<sup>1)</sup> To obtain the article number for ordering, read under selected part number and actuating voltage from the table.  
Devices with dual-voltage coils are to be ordered under a single article number.

AC	DILEM-10(...)	DILEM-01(...)	DILEM12-10(...)	DILEM12-01(...)	DILEM4(...)
	Article no. <sup>1)</sup>	Article no. <sup>1)</sup>	Article no. <sup>1)</sup>	Article no. <sup>1)</sup>	Article no. <sup>1)</sup>
<b>Standard voltages</b>	See price list	See price list	See price list	See price list	See price list
24V 50Hz	010005	010086	127067	127083	014754
48V 50Hz	010020	010294	–	–	–
240V 50Hz	010032	010151	–	–	014305
115V 60Hz	010024	010470	–	–	–
42V 50Hz, 48V 60Hz	051782	051791	–	–	–
110V 50Hz, 120V 60Hz	051783	051792	127072	127088	051801
190V 50Hz, 220V 60Hz	051784	051793	–	–	–
220V 50Hz, 240V 60Hz	051785	051794	–	–	051803
230V 50Hz, 240V 60Hz	051786	051795	–	–	051804
380V 50Hz, 440V 60Hz	051787	051796	–	–	–
400V 50Hz, 440V 60Hz	051788	051797	–	–	051806
415V 50Hz, 480V 60Hz	051789	–	–	–	–
24V 50/60Hz	021417	020402	127079	127095	022044
42V 50/60Hz	032174	033233	–	–	–
110V 50/60Hz	021455	020436	127081	127097	–
230V 50/60Hz	052302	051114	127082	127098	052506
DC	DILEM-10-G(...)	DILEM-01-G(...)	DILEM12-10-G(...)	DILEM12-01-G(...)	DILEM4-G(...)
	Article no. <sup>1)</sup>	Article no. <sup>1)</sup>	Article no. <sup>1)</sup>	Article no. <sup>1)</sup>	Article no. <sup>1)</sup>
<b>Standard voltages</b>	See price list	See price list	See price list	See price list	See price list
12V DC	079594	079642	–	–	079680
24V DC	010213	010343	127132	127137	012701
48V DC	010245	010496	–	–	–
110V DC	010309	010136	–	–	–
220V DC	010325	010168	–	–	–

**Notes**

<sup>1)</sup> To obtain the article number for ordering, read under selected part number and actuating voltage from the table. Devices with **dual-voltage coils** are to be ordered under a **single** article number.



AC	With screw terminals			With Spring-loaded terminals		
	DILA-40(...)	DILA-31(...)	DILA-22(...)	DILAC-40(...)	DILAC-31(...)	DILAC-22(...)
	Article no. <sup>1)</sup>	Article no. <sup>1)</sup>	Article no. <sup>1)</sup>	Article no. <sup>1)</sup>	Article no. <sup>1)</sup>	Article no. <sup>1)</sup>
<b>Standard voltages</b>	See price list	See price list	See price list	See price list	See price list	See price list
<b>24V 50Hz</b>	276316	276351	276386	276431	276463	276495
<b>240V 50Hz</b>	276318	276353	276388	–	–	–
<b>110V 50Hz 120V 60Hz</b>	276326	276361	276396	276438	276470	276502
<b>190V 50Hz 220V 60Hz</b>	276327	276362	276397	–	–	–
<b>220V 50Hz 240V 60Hz</b>	276328	276363	276398	–	–	–
<b>230V 50Hz 240V 60Hz</b>	276329	276364	276399	276441	276473	276505
<b>380V 50Hz 440V 60Hz</b>	276330	276365	276400	–	–	–
<b>400V 50Hz 440V 60Hz</b>	276331	276366	276401	–	–	–
<b>24V 50Hz/60Hz</b>	276333	276368	276403	276445	276477	276509
<b>42V 50Hz/60Hz</b>	276334	276369	276404	–	–	–
<b>110V 50Hz/60Hz</b>	276335	276370	276405	–	–	–
<b>220V 50Hz/60Hz</b>	276336	276371	276406	–	–	–
<b>230V 50Hz/60Hz</b>	276337	276372	276407	276449	276481	276513
Special voltages other than the already shown normal voltages <sup>2)</sup>	See price list	See price list	See price list	See price list	See price list	See price list
<b>...V 50Hz(12-500V)<sup>3)</sup></b>	276341	276376	276411	276453	276485	276517
<b>...V 60Hz(12-600V)<sup>3)</sup></b>	276342	276377	276412	276454	276486	276518
DC	With screw terminals			With Spring-loaded terminals		
	DILA-40(...)	DILA-31(...)	DILA-22(...)	DILAC-40(...)	DILAC-31(...)	DILAC-22(...)
	Article no. <sup>1)</sup>	Article no. <sup>1)</sup>	Article no. <sup>1)</sup>	Article no. <sup>1)</sup>	Article no. <sup>1)</sup>	Article no. <sup>1)</sup>
<b>Standard voltages</b>	See price list	See price list	See price list	See price list	See price list	See price list
<b>24V DC</b>	276344	276379	276414	276456	276488	276520
<b>48V DC</b>	276345	276380	276415	–	–	–
<b>110V DC</b>	276347	276382	276417	276459	276491	276523
<b>220V DC</b>	276348	276383	276418	276460	276492	276524
Special voltages other than the already shown normal voltages <sup>2)</sup>	See price list	See price list	See price list	See price list	See price list	See price list
<b>...V DC(12-250V)<sup>3)</sup></b>	276349	276384	276419	276461	276493	276525

**Notes**

<sup>1)</sup> The article number is a combination of part no. and operating voltage devices with dual-voltage coils can be ordered under a single article no.

<sup>2)</sup> With non-standard voltages the required actuating voltage from the defined range (...-...V) must be stated.

<sup>3)</sup> Minimum order quantity 10 units



HPL05073EN

**DILM**

AC	DILM7-10 (...)	DILM7-01 (...)	DILM9-10 (...)	DILM9-01 (...)	DILM12-10 (...)	DILM12-01 (...)	DILM15-10 (...)	DILM15-01 (...)
	Article no. <sup>1)</sup>	Article no. <sup>1)</sup>	Article no. <sup>1)</sup>	Article no. <sup>1)</sup>	Article no. <sup>1)</sup>	Article no. <sup>1)</sup>	Article no. <sup>1)</sup>	Article no. <sup>1)</sup>
<b>Standard voltages</b>	See price list	See price list	See price list	See price list	See price list	See price list	See price list	See price list
<b>24V 50Hz</b>	276537	276572	276677	276712	276817	276852	290045	290080
<b>240V 50Hz</b>	276539	276574	276679	276714	276819	276854	–	–
<b>42V 50Hz 48V 60Hz</b>	276546	–	276686	–	276826	–	–	–
<b>110V 50Hz 120V 60Hz</b>	276547	276582	276687	276722	276827	276862	290055	290090
<b>190V 50Hz 220V 60Hz</b>	276548	276583	276688	276723	276828	276863	–	–
<b>220V 50Hz 240V 60Hz</b>	276549	276584	276689	276724	276829	276864	–	–
<b>230V 50Hz 240V 60Hz</b>	276550	276585	276690	276725	276830	276865	290058	290093
<b>380V 50Hz 440V 60Hz</b>	276551	276586	276691	276726	276831	276866	–	–
<b>400V 50Hz 440V 60Hz</b>	276552	276587	276692	276727	276832	276867	–	–
<b>415V 50Hz 480V 60Hz</b>	276553	–	276693	–	276833	–	–	–
<b>24V 50Hz/60Hz</b>	276554	276589	276694	276729	276834	276869	290062	290097
<b>42V 50Hz/60Hz</b>	276555	276590	276695	276730	276835	276870	–	–
<b>110V 50Hz/60Hz</b>	276556	276591	276696	276731	276836	276871	–	–
<b>220V 50Hz/60Hz</b>	276557	276592	276697	276732	276837	276872	–	–
<b>230V 50Hz/60Hz</b>	276558	276593	276698	276733	276838	276873	290066	290101
Special voltages other than the already shown normal voltages <sup>2)</sup>	See price list	See price list	See price list	See price list	See price list	See price list	See price list	See price list
<b>...V 50Hz (12 – 600V)<sup>3)</sup></b>	276562	276597	276702	276737	276842	276877	290070	290105
<b>...V 60Hz (12 – 600V)<sup>3)</sup></b>	276563	276598	276703	276738	276843	276878	290071	290106
<b>DC</b>	<b>DILM7-10 (...)</b>	<b>DILM7-01 (...)</b>	<b>DILM9-10 (...)</b>	<b>DILM9-01 (...)</b>	<b>DILM12-10 (...)</b>	<b>DILM12-01 (...)</b>	<b>DILM15-10 (...)</b>	<b>DILM15-01 (...)</b>
	Article no. <sup>1)</sup>	Article no. <sup>1)</sup>	Article no. <sup>1)</sup>	Article no. <sup>1)</sup>	Article no. <sup>1)</sup>	Article no. <sup>1)</sup>	Article no. <sup>1)</sup>	Article no. <sup>1)</sup>
<b>Standard voltages</b>	See price list	See price list	See price list	See price list	See price list	See price list	See price list	See price list
<b>24V DC</b>	276565	276600	276705	276740	276845	276880	290073	290108
<b>48V DC</b>	276566	276601	276706	276741	276846	276881	–	–
<b>110V DC</b>	276568	276603	276708	276743	276848	276883	–	–
<b>220V DC</b>	276569	276604	276709	276744	276849	276884	–	–
Special voltages other than the already shown normal voltages <sup>2)</sup>	See price list	See price list	See price list	See price list	See price list	See price list	See price list	See price list
<b>...V DC (12-250V)<sup>3)</sup></b>	276570	276605	276710	276745	276850	276885	290078	290113

**Notes**

- <sup>1)</sup> To obtain the article number for ordering, read under selected part number and actuating voltage from the table. devices with dual-voltage coils can be ordered under a single article no.
- <sup>2)</sup> With non-standard voltages the required actuating voltage from the defined range (...–...V) must be stated.
- <sup>3)</sup> Minimum order quantity 10 units

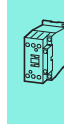

AC	DILM17-10 (...)	DILM17-01 (...)	DILM25-10 (...)	DILM25-01 (...)	DILM32-10 (...)	DILM32-01 (...)	DILM38-10(...)	DILM38-01(...)
	Article no. <sup>1)</sup>	Article no. <sup>1)</sup>	Article no. <sup>1)</sup>	Article no. <sup>1)</sup>	Article no. <sup>1)</sup>	Article no. <sup>1)</sup>	Article no. <sup>1)</sup>	Article no. <sup>1)</sup>
<b>Standard voltages</b>	See price list	See price list	See price list	See price list	See price list	See price list	See price list	See price list
<b>24V 50Hz</b>	276991	277023	277119	277151	277247	277279	112378	112446
<b>240V 50Hz</b>	276993	–	277121	–	277249	–	112420	–
<b>42V 50Hz 48V 60Hz</b>	277000	–	277128	–	277256	–	112424	–
<b>110V 50Hz 120V 60Hz</b>	277001	277033	277129	277161	277257	277289	112425	112454
<b>190V 50Hz 220V 60Hz</b>	277002	–	277130	–	277258	–	112426	–
<b>220V 50Hz 240V 60Hz</b>	277003	–	277131	–	277259	–	112427	–
<b>230V 50Hz 240V 60Hz</b>	277004	277036	277132	277164	277260	277292	112428	112457
<b>380V 50Hz 440V 60Hz</b>	277005	–	277133	–	277261	–	112429	–
<b>400V 50Hz 440V 60Hz</b>	277006	277038	277134	277166	277262	277294	112430	112459
<b>415V 50Hz 480V 60Hz</b>	277007	–	277135	–	277263	–	112431	–
<b>24V 50Hz/60Hz</b>	277008	277040	277136	277168	277264	277296	112432	112461
<b>42V 50Hz/60Hz</b>	277009	–	277137	–	277265	–	112433	–
<b>110V 50Hz/60Hz</b>	277010	277042	277138	277170	277266	277298	112434	112463
<b>220V 50Hz/60Hz</b>	277011	277043	277139	277171	277267	277299	112435	112464
<b>230V 50Hz/60Hz</b>	277012	277044	277140	277172	277268	277300	112436	112465
Special voltages other than the already shown normal voltages <sup>2)</sup>	See price list	See price list	See price list	See price list	See price list	See price list	See price list	See price list
<b>...V 50Hz (24 – 600V)</b>	277016 <sup>7)</sup>	277048 <sup>7)</sup>	277144 <sup>7)</sup>	277176 <sup>7)</sup>	277272 <sup>7)</sup>	277304 <sup>8)</sup>	112440 <sup>7)</sup>	112468 <sup>7)</sup>
<b>...V 60Hz (24 – 600V)</b>	277017 <sup>7)</sup>	277049 <sup>7)</sup>	277145 <sup>7)</sup>	277177 <sup>7)</sup>	277273 <sup>7)</sup>	277305 <sup>8)</sup>	112441 <sup>7)</sup>	112469 <sup>7)</sup>
<b>DC</b>	<b>DILM17-10(...)</b>	<b>DILM17-01(...)</b>	<b>DILM25-10(...)</b>	<b>DILM25-01(...)</b>	<b>DILM32-10(...)</b>	<b>DILM32-01(...)</b>	<b>DILM38-10(...)</b>	<b>DILM38-01(...)</b>
	Article no. <sup>1)</sup>	Article no. <sup>1)</sup>	Article no. <sup>1)</sup>	Article no. <sup>1)</sup>	Article no. <sup>1)</sup>	Article no. <sup>1)</sup>	Article no. <sup>1)</sup>	Article no. <sup>1)</sup>
<b>Standard voltages</b>	See price list	See price list	See price list	See price list	See price list	See price list	See price list	See price list
<b>RDC 24 <sup>3)</sup></b>	277018	277050	277146	277178	277274	277306	112442	112470
<b>RDC 60 <sup>4)</sup></b>	277019	277051	277147	277179	277275	277307	112443	112471
<b>RDC 130 <sup>5)</sup></b>	277020	277052	277148	277180	277276	277308	112444	112472
<b>RDC 240 <sup>6)</sup></b>	277021	277053	277149	277181	277277	277309	112445	112473

**Notes**

- <sup>1)</sup> To obtain the article number for ordering, read under selected part number and actuating voltage from the table. devices with dual-voltage coils can be ordered under a single article no.
- <sup>2)</sup> With non-standard voltages the required actuating voltage from the defined range (...–...V) must be stated.
- <sup>3)</sup> 24 – 27 V DC
- <sup>4)</sup> 48 – 60 V DC
- <sup>5)</sup> 110 – 130 V DC
- <sup>6)</sup> 200 – 240 V DC
- <sup>7)</sup> Minimum order quantity 10 units
- <sup>8)</sup> Minimum order quantity 5 units

**DILM**

HPL05075EN

AC	DILM40(...)	DILM50(...)	DILM65(...)	DILM72(...)
	Article no. <sup>1)</sup>	Article no. <sup>1)</sup>	Article no. <sup>1)</sup>	Article no. <sup>1)</sup>
<b>Standard voltages</b>	See price list	See price list	See price list	See price list
24V 50Hz	277753	277817	277881	–
240V 50Hz	277755	277819	277883	109183
42V 50Hz 48V 60Hz	277762	277826	277890	–
110V 50Hz 120V 60Hz	277763	277827	277891	109191
190V 50Hz 220V 60Hz	277764	277828	277892	–
220V 50Hz 240V 60Hz	277765	277829	277893	–
230V 50Hz 240V 60Hz	277766	277830	277894	107670
380V 50Hz 440V 60Hz	277767	277831	277895	–
400V 50Hz 440V 60Hz	277768	277832	277896	109195
415V 50Hz 480V 60Hz	277769	277833	277897	–
24V 50Hz/60Hz	277770	277834	277898	109197
42V 50Hz/60Hz	277771	277835	277899	–
110V 50Hz/60Hz	277772	277836	277900	109199
220V 50Hz/60Hz	277773	277837	277901	109200
230V 50Hz/60Hz	277774	277838	277902	109201
Special voltages other than the already shown normal voltages <sup>2)</sup>	See price list	See price list	See price list	See price list
...V 50Hz (24 – 600V)	277778 <sup>8)</sup>	277842 <sup>8)</sup>	277906 <sup>8)</sup>	109205 <sup>7)</sup>
...V 60Hz (24 – 600V)	277779 <sup>8)</sup>	277843 <sup>8)</sup>	277907 <sup>8)</sup>	109206 <sup>7)</sup>
<b>DC</b>	<b>DILM40(...)</b>	<b>DILM50(...)</b>	<b>DILM65(...)</b>	<b>DILM72(...)</b>
	Article no. <sup>1)</sup>	Article no. <sup>1)</sup>	Article no. <sup>1)</sup>	Article no. <sup>1)</sup>
<b>Standard voltages</b>	See price list	See price list	See price list	See price list
RDC 24 <sup>3)</sup>	277780	277844	277908	107671
RDC 60 <sup>4)</sup>	277781	277845	277909	–
RDC 130 <sup>5)</sup>	277782	277846	277910	–
RDC 240 <sup>6)</sup>	277783	277847	277911	109209

**Notes**

- <sup>1)</sup> To obtain the article number for ordering, read under selected part number and actuating voltage from the table.  
devices with dual-voltage coils can be ordered under a single article no.
- <sup>2)</sup> With non-standard voltages the required actuating voltage from the defined range (...-...V) must be stated.
- <sup>3)</sup> 24 – 27 V DC
- <sup>4)</sup> 48 – 60 V DC
- <sup>5)</sup> 110 – 130 V DC
- <sup>6)</sup> 200 – 240 V DC
- <sup>7)</sup> Minimum order quantity 10 units

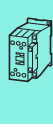

AC	DILM80 (...)	DILM95 (...)	AC	DILM115 (...)	DILM150 (...)	DILM170 (...)	DILM185A/ 22(...)	DILM225A/ 22(...)						
	Article no. <sup>1)</sup>	Article no. <sup>1)</sup>		Article no. <sup>1)</sup>	Article no. <sup>1)</sup>	Article no. <sup>1)</sup>	Article no. <sup>1)</sup>	Article no. <sup>1)</sup>						
Standard voltages	See price list	See price list	Standard voltages	See price list	See price list	See price list	See price list	See price list						
<b>24 V 50 Hz</b>	235904	239467	<b>RAC 24<sup>7)</sup></b>	239545	239585	107010	139534	139544						
<b>240V 50Hz</b>	235910	239469	<b>RAC 48<sup>8)</sup></b>	239546	239586	107011	139535	139545						
<b>42V 50Hz 48V 60Hz</b>	239394	239476	<b>RAC 120<sup>9)</sup></b>	239547	239587	107012	139536	139546						
<b>110V 50Hz 120V 60Hz</b>	239399	239477	<b>RAC 240<sup>10)</sup></b>	239548	239588	107013	139537	139547						
<b>190V 50Hz 220V 60Hz</b>	239400	239478	<b>RAC 440<sup>11)</sup></b>	239549	239589	107014	139538	139548						
<b>220V 50Hz 240V 60Hz</b>	239401	239479	<b>RAC 500<sup>12)</sup></b>	239550	239590	107015	139539	139549						
<b>230V 50Hz 240V 60Hz</b>	239402	239480	<b>DC</b>	<b>DILM115 (...)</b>	<b>DILM150 (...)</b>	<b>DILM170 (...)</b>	<b>DILM185A/ 22(...)</b>	<b>DILM225A/ 22(...)</b>						
<b>380V 50Hz 440V 60Hz</b>	239403	239481							Article no. <sup>1)</sup>	Article no. <sup>1)</sup>	Article no. <sup>1)</sup>	Article no. <sup>1)</sup>	Article no. <sup>1)</sup>	
<b>400V 50Hz 440V 60Hz</b>	239404	239482							See price list	See price list	See price list	See price list	See price list	
<b>415V 50Hz 480V 60Hz</b>	239405	239483							<b>RDC 24<sup>3)</sup></b>	239555	239591	107016	139540	139550
<b>24V 50Hz/60Hz</b>	239406	239484							<b>RDC 60<sup>4)</sup></b>	239560	239592	107017	139541	139551
<b>42V 50Hz/60Hz</b>	239407	239485							<b>RDC 130<sup>5)</sup></b>	239567	239593	107018	139542	139552
<b>110V 50Hz/60Hz</b>	239408	239486							<b>RDC 240<sup>6)</sup></b>	239572	239594	107019	139543	139553
<b>220V 50Hz/60Hz</b>	239409	239487							<b>Notes</b>	<sup>1)</sup> The article no. results from combining the part no. and the actuating voltage. Devices with dual-voltage coils must be ordered under a single article no. <sup>2)</sup> With non-standard voltages the required actuating voltage from the defined range (...-...V) must be stated. <sup>3)</sup> 24 - 27 V DC <sup>4)</sup> 48 - 60 V DC <sup>5)</sup> 110 - 130 V DC <sup>6)</sup> 200 - 240 V DC <sup>7)</sup> 24 V 50/60 Hz <sup>8)</sup> 42 - 48 V 50/60 Hz <sup>9)</sup> 100 - 120 V 50/60 Hz <sup>10)</sup> 190 - 240 V 50/60 Hz <sup>11)</sup> 380 - 440 V 50/60 Hz <sup>12)</sup> 480 - 500 V 50/60 Hz <sup>13)</sup> Minimum order quantity 5 units				
<b>230V 50Hz/60Hz</b>	239410	239488												
Special voltages other than the already shown normal voltages <sup>2)</sup>	See price list	See price list												
<b>...V 50Hz (24 - 600V) <sup>13)</sup></b>	239414	239504												
<b>...V 60Hz (24 - 600V) <sup>13)</sup></b>	239415	239509												
<b>DC</b>	<b>DILM80 (...)</b>	<b>DILM95 (...)</b>												
	Article no. <sup>1)</sup>	Article no. <sup>1)</sup>												
Standard voltages	See price list	See price list												
<b>RDC 24<sup>3)</sup></b>	239416	239510												
<b>RDC 60<sup>4)</sup></b>	239417	239511												
<b>RDC 130<sup>5)</sup></b>	239418	239512												
<b>RDC 240<sup>6)</sup></b>	239419	239513												

DILM

HPL05077EN

AC	DILMC7-10 (...)	DILMC7-01 (...)	DILMC9-10 (...)	DILMC9-01 (...)	DILMC12-10 (...)	DILMC12-01 (...)	DILMC15-10 (...)	DILMC15-01 (...)
	Article no. <sup>1)</sup>	Article no. <sup>1)</sup>	Article no. <sup>1)</sup>	Article no. <sup>1)</sup>	Article no. <sup>1)</sup>	Article no. <sup>1)</sup>	Article no. <sup>1)</sup>	Article no. <sup>1)</sup>
<b>Standard voltages</b>	See price list	See price list	See price list	See price list	See price list	See price list	See price list	See price list
<b>24 V 50 Hz</b>	277379	277411	277443	277475	277507	277539	293938	293933
<b>110V 50Hz 120V 60Hz</b>	277386	277418	277450	277482	277514	277546	293908	293943
<b>230V 50Hz 240V 60Hz</b>	277389	277421	277453	277485	277517	277549	293911	293946
<b>24V 50Hz/60Hz</b>	277393	277425	277457	277489	277521	277553	293915	293950
<b>230V 50Hz/60Hz</b>	277397	277429	277461	277493	277525	277557	293919	293954
Special voltages other than the already shown normal voltages <sup>2)</sup>	See price list	See price list	See price list	See price list	See price list	See price list	See price list	See price list
<b>...V 50Hz (12 – 600V)<sup>6)</sup></b>	277401	277433	277465	277497	277529	277561	293923	293958
<b>...V 60Hz (12 – 600V)<sup>6)</sup></b>	277402	277434	277466	277498	277530	277562	293924	293959
<b>DC</b>	<b>DILMC7-10</b> (...)	<b>DILMC7-01</b> (...)	<b>DILMC9-10</b> (...)	<b>DILMC9-01</b> (...)	<b>DILMC12-10</b> (...)	<b>DILMC12-01</b> (...)	<b>DILMC15-10</b> (...)	<b>DILMC15-01</b> (...)
	Article no. <sup>1)</sup>	Article no. <sup>1)</sup>	Article no. <sup>1)</sup>	Article no. <sup>1)</sup>	Article no. <sup>1)</sup>	Article no. <sup>1)</sup>	Article no. <sup>1)</sup>	Article no. <sup>1)</sup>
<b>Standard voltages</b>	See price list	See price list	See price list	See price list	See price list	See price list	See price list	See price list
<b>24V DC</b>	277404	277436	277468	277500	277532	277564	293926	293961
<b>110V DC</b>	277407	277439	277471	277503	277535	277567	293929	293964
<b>220V DC</b>	277408	277440	277472	277504	277536	277568	293930	293965
Special voltages other than the already shown normal voltages <sup>2)</sup>	See price list	See price list	See price list	See price list	See price list	See price list	See price list	See price list
<b>...VDC (12 – 250V)<sup>6)</sup></b>	277409	277441	277473	277505	277537	277569	293931	293966
<b>AC</b>	<b>DILMC17-10</b> (...)	<b>DILMC17-01</b> (...)	<b>DILMC25-10</b> (...)	<b>DILMC25-01</b> (...)	<b>DILMC32-10</b> (...)	<b>DILMC32-01</b> (...)		
	Article no. <sup>1)</sup>	Article no. <sup>1)</sup>	Article no. <sup>1)</sup>	Article no. <sup>1)</sup>	Article no. <sup>1)</sup>	Article no. <sup>1)</sup>	Article no. <sup>1)</sup>	
<b>Standard voltages</b>	See price list	See price list	See price list	See price list	See price list	See price list	See price list	
<b>24 V 50 Hz</b>	277570	277600	277630	277660	277690	277720		
<b>110V 50Hz 120V 60Hz</b>	277578	277608	277638	277668	277698	277728		
<b>230V 50Hz 240V 60Hz</b>	277581	277611	277641	277671	277701	277731		
<b>24V 50Hz/60Hz</b>	277585	277615	277645	277675	277705	277735		
<b>220V 50Hz/60Hz</b>	277588	277618	277648	277678	277708	277738		
<b>230V 50Hz/60Hz</b>	277589	277619	277649	277679	277709	277739		
Special voltages other than the already shown normal voltages <sup>2)</sup>	See price list	See price list	See price list	See price list	See price list	See price list	See price list	
<b>...V 50Hz (24 – 600V)<sup>6)</sup></b>	277593	277623	277653	277683	277713	277743		
<b>...V 60Hz (24 – 600V)<sup>6)</sup></b>	277594	277624	277654	277684	277714	277744		
<b>DC</b>	<b>DILMC17-10</b> (...)	<b>DILMC17-01</b> (...)	<b>DILMC25-10</b> (...)	<b>DILMC25-01</b> (...)	<b>DILMC32-10</b> (...)	<b>DILMC32-01</b> (...)		
	Article no. <sup>1)</sup>	Article no. <sup>1)</sup>	Article no. <sup>1)</sup>	Article no. <sup>1)</sup>	Article no. <sup>1)</sup>	Article no. <sup>1)</sup>	Article no. <sup>1)</sup>	
<b>Standard voltages</b>	See price list	See price list	See price list	See price list	See price list	See price list	See price list	
<b>RDC 24<sup>3)</sup></b>	277595	277625	277655	277685	277715	277745		
<b>RDC 130<sup>4)</sup></b>	277597	277627	277657	277687	277717	277747		
<b>RDC 240<sup>5)</sup></b>	277598	277628	277658	277688	277718	277748		

Notes

- <sup>1)</sup> The article no. results from combining the part no. and the actuating voltage.  
Devices with dual-voltage coils must be ordered under a single article no.
- <sup>2)</sup> With non-standard voltages the required actuating voltage from the defined range (...-...V) must be stated.
- <sup>3)</sup> 24 - 27 V DC
- <sup>4)</sup> 110 - 130 V DC
- <sup>5)</sup> 200 - 240 V DC
- <sup>6)</sup> Minimum order quantity 10 units

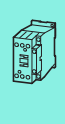

AC	DILMP20 (...)	DILMP32- 10	DILMP32- 01	DILMP45- 10	DILMP45- 01	DILMP63 (...)	DILMP80 (...)	DILMP125 (...)	DILMP160 (...)	DILMP200 (...)
	Article no. <sup>1)</sup>	Article no. <sup>1)</sup>	Article no. <sup>1)</sup>	Article no. <sup>1)</sup>	Article no. <sup>1)</sup>	Article no. <sup>1)</sup>	Article no. <sup>1)</sup>	Article no. <sup>1)</sup>	Article no. <sup>1)</sup>	Article no. <sup>1)</sup>
<b>Standard voltages</b>	See price list	See price list	See price list	See price list	See price list	See price list	See price list	See price list	See price list	See price list
<b>240V 50Hz</b>	–	109798	–	109827	–	109856	109885	–	–	–
<b>110V 50Hz 120V 60Hz</b>	276967	109790	118912	109819	118915	109848	109877	–	–	–
<b>230 V 50Hz 240V 60Hz</b>	276970	109797	118911	109826	118914	109855	109884	–	–	–
<b>24V 50/60Hz</b>	276974	109799	–	109828	–	109857	109886	–	–	–
<b>230V 50/60Hz</b>	276978	109796	–	109825	–	109883	109883	–	–	–
<b>AC</b>	Article no. <sup>1)</sup>	Article no. <sup>1)</sup>	Article no. <sup>1)</sup>	Article no. <sup>1)</sup>	Article no. <sup>1)</sup>	Article no. <sup>1)</sup>	Article no. <sup>1)</sup>	Article no. <sup>1)</sup>	Article no. <sup>1)</sup>	Article no. <sup>1)</sup>
<b>Standard voltages</b>	See price list	See price list	See price list	See price list	See price list	See price list	See price list	See price list	See price list	See price list
<b>RAC 24<sup>4)</sup></b>	–	–	–	–	–	–	–	109904	109914	109924
<b>RAC 120<sup>5)</sup></b>	–	–	–	–	–	–	–	109903	109913	109923
<b>RAC 240<sup>6)</sup></b>	–	–	–	–	–	–	–	109905	109915	109925
<b>AC</b>	Article no. <sup>1)</sup>	Article no. <sup>1)</sup>	Article no. <sup>1)</sup>	Article no. <sup>1)</sup>	Article no. <sup>1)</sup>	Article no. <sup>1)</sup>	Article no. <sup>1)</sup>	Article no. <sup>1)</sup>	Article no. <sup>1)</sup>	Article no. <sup>1)</sup>
Non-standard voltages <sup>2)</sup>	See price list	See price list	See price list	See price list	See price list	See price list	See price list	See price list	See price list	See price list
<b>... V 50Hz (12 – 600V)<sup>3)</sup></b>	276982	109787	109787	109816	109816	109845	109874	–	–	–
<b>... V 60Hz (12 – 600V)<sup>3)</sup></b>	276983	109788	109788	109817	109817	109846	109875	–	–	–
<b>DC</b>	Article no. <sup>1)</sup>	Article no. <sup>1)</sup>	Article no. <sup>1)</sup>	Article no. <sup>1)</sup>	Article no. <sup>1)</sup>	Article no. <sup>1)</sup>	Article no. <sup>1)</sup>	Article no. <sup>1)</sup>	Article no. <sup>1)</sup>	Article no. <sup>1)</sup>
<b>Standard voltages</b>	See price list	See price list	See price list	See price list	See price list	See price list	See price list	See price list	See price list	See price list
<b>24V DC</b>	276985	–	–	–	–	–	–	–	–	–
<b>RDC 24<sup>7)</sup></b>	–	109811	118913	109840	118916	109869	109898	109910	109920	109930
<b>DC</b>	Article no. <sup>1)</sup>	Article no. <sup>1)</sup>	Article no. <sup>1)</sup>	Article no. <sup>1)</sup>	Article no. <sup>1)</sup>	Article no. <sup>1)</sup>	Article no. <sup>1)</sup>	Article no. <sup>1)</sup>	Article no. <sup>1)</sup>	Article no. <sup>1)</sup>
Non-standard voltages <sup>2)</sup>	See price list	See price list	See price list	See price list	See price list	See price list	See price list	See price list	See price list	See price list
<b>... V DC (12 – 250V)<sup>3)</sup></b>	276990	–	–	–	–	–	–	–	–	–

## Notes

<sup>1)</sup> The article number is a combination of part no. and actuating voltage

<sup>2)</sup> For non-standard voltages, state the actuating voltage selected from the range (...–...V) shown.

<sup>3)</sup> Minimum order quantity: 10 units

<sup>4)</sup> 24 V 50/60 Hz

<sup>5)</sup> 100 – 120 V 50/60 Hz

<sup>6)</sup> 190 – 240 V 50/60 Hz

<sup>7)</sup> 24 – 27 V DC

**DILM...XSP...**

HPL05079EN

AC	DILM32-XSP (...)	DILM65-XSP (...)	DILM95- XSP
	Article no. <sup>1)</sup>	Article no. <sup>1)</sup>	Article no. <sup>1)</sup>
<b>Standard voltages</b>	See price list	See price list	See price list
<b>24V 50Hz</b>	281130	281160	229984
<b>240V 50Hz</b>	281132	281162	229986
<b>24V 60Hz</b>	281134	281164	229988
<b>115V 60Hz</b>	281136	281166	229990
<b>42V 50Hz 48V 60Hz</b>	281137	281167	229994
<b>110V 50Hz 120V 60Hz</b>	281138	281168	230058
<b>190V 50Hz 220V 60Hz</b>	281139	281169	230059
<b>220V 50Hz 240V 60Hz</b>	281140	281170	230061
<b>230V 50Hz 240V 60Hz</b>	281141	281171	230062
<b>380V 50Hz 440V 60Hz</b>	281142	281172	230063
<b>400V 50Hz 440V 60Hz</b>	281143	281173	230064
<b>415V 50Hz 480V 60Hz</b>	281144	281174	230065
<b>24V 50Hz/60Hz</b>	281145	281175	230066
<b>42V 50Hz/60Hz</b>	281146	281176	230067
<b>110V 50Hz/60Hz</b>	281147	281177	230068
<b>220V 50Hz/60Hz</b>	281148	281178	230073
<b>230V 50Hz/60Hz</b>	281149	281179	230074
Special voltages other than the already shown normal-voltages <sup>2)</sup>	See price list	See price list	See price list
<b>...V 50Hz (24 – 600V)</b>	281153 <sup>13)</sup>	281183 <sup>14)</sup>	230078 <sup>14)</sup>
<b>...V 60Hz (24 – 600V)</b>	281154 <sup>13)</sup>	281184 <sup>14)</sup>	230079 <sup>14)</sup>
DC	DILM32-XSP (...)	DILM65-XSP (...)	DILM95- XSP
	Article no. <sup>1)</sup>	Article no. <sup>1)</sup>	Article no. <sup>1)</sup>
<b>Standard voltages</b>	See price list	See price list	See price list
<b>RDC 24<sup>3)</sup></b>	281155	281185	230080
<b>RDC 60<sup>4)</sup></b>	281156	281186	230081
<b>RDC 130<sup>5)</sup></b>	281157	281187	230082
<b>RDC 240<sup>6)</sup></b>	281158	281188	230107

AC	DILM150-XSP (...)	DILM225A-XSP (...)
	Article no. <sup>1)</sup>	Article no. <sup>1)</sup>
<b>Standard voltages</b>	See price list	See price list
<b>RAC 24<sup>7)</sup></b>	230109	139562
<b>RAC 48<sup>8)</sup></b>	230110	139563
<b>RAC 120<sup>9)</sup></b>	230111	139564
<b>RAC 240<sup>10)</sup></b>	230112	139565
<b>RAC 440<sup>11)</sup></b>	230113	139566
<b>RAC 500<sup>12)</sup></b>	230114	139567
DC	DILM150-XSP (...)	DILM225A-XSP (...)
	Article no. <sup>1)</sup>	Article no. <sup>1)</sup>
<b>Standard voltages</b>	See price list	See price list
<b>RDC 24<sup>3)</sup></b>	230115	139568
<b>RDC 60<sup>4)</sup></b>	230116	139569
<b>RDC 130<sup>5)</sup></b>	230117	139570
<b>RDC 240<sup>6)</sup></b>	230122	139571

**Notes**

- 1) To obtain the article number for ordering, read under selected part number and actuating voltage from the table.  
Devices with dual-voltage coils are to be ordered under a single article number.
- 2) With non-standard voltages the required actuating voltage from the defined range (...-...V) must be stated.
- 3) 24 – 27 V DC
- 4) 48 – 60 V DC
- 5) 110 – 130 V DC
- 6) 200 – 240 V DC
- 7) 24 V 50/60 Hz
- 8) 42 – 48 V 50/60 Hz
- 9) 100 – 120 V 50/60 Hz
- 10) 190 – 240 V 50/60 Hz
- 11) 380 – 440 V 50/60 Hz
- 12) 480 – 500 V 50/60 Hz
- 13) Minimum order quantity 10 units
- 14) Minimum order quantity 5 units

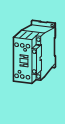

AC	DILK12-11 (...)	DILK20-11 (...)	DILK25-11 (...)	DILK33-10 (...)	DILK50-10 (...)
	Article no. <sup>1)</sup>	Article no. <sup>1)</sup>	Article no. <sup>1)</sup>	Article no. <sup>1)</sup>	Article no. <sup>1)</sup>
Standard voltages	See price list	See price list	See price list	See price list	See price list
110V 50Hz, 120V 60Hz	293985	294007	294029	294051	294073
190V 50Hz, 220V 60Hz	293986	294008	294030	294052	294074
230V 50Hz, 240V 60Hz	293988	294010	294032	294054	294076
400V 50Hz, 440V 60Hz	293990	294012	294034	294056	294078
Special voltages other than the already shown normal voltages <sup>2)</sup>	See price list	See price list	See price list		
...V 50Hz (24 – 600V) <sup>3)</sup>	293997	294019	294041	–	–
...V 60Hz (24 – 600V) <sup>3)</sup>	293998	294020	294042	–	–

## Notes

<sup>1)</sup> The article no. results from combining the part no. and the actuating voltage.

Devices with dual-voltage coils must be ordered under a single article no.

<sup>2)</sup> With non-standard voltages the required actuating voltage from the defined range (...-...V) must be stated.

<sup>3)</sup> Minimum order quantity 10 units

## Contactors up to 150 A with electronic actuation

AC	DILMF8-10 (...)	DILMF8-01 (...)	DILMF11-10 (...)	DILMF11-01 (...)	DILMF14-10 (...)	DILMF14-01 (...)	DILMF17-10 (...)
	Article no. <sup>1)</sup>	Article no. <sup>1)</sup>	Article no. <sup>1)</sup>	Article no. <sup>1)</sup>	Article no. <sup>1)</sup>	Article no. <sup>1)</sup>	Article no. <sup>1)</sup>
Standard voltages	See price list	See price list	See price list	See price list	See price list	See price list	See price list
RAC 24 <sup>1)</sup>	104410	104414	104418	104422	104426	104430	104434
RAC 48 <sup>3)</sup>	104411	104415	104419	104423	104427	104431	104435
RAC 120 <sup>4)</sup>	104412	104416	104420	104424	104428	104432	104436
RAC 240 <sup>5)</sup>	104413	104417	104421	104425	104429	104433	104437
AC	DILMF17-01 (...)	DILMF25-10 (...)	DILMF25-01 (...)	DILMF32-10 (...)	DILMF32-01 (...)	DILMF40 (...)	DILMF50 (...)
	Article no. <sup>1)</sup>	Article no. <sup>1)</sup>	Article no. <sup>1)</sup>	Article no. <sup>1)</sup>	Article no. <sup>1)</sup>	Article no. <sup>1)</sup>	Article no. <sup>1)</sup>
Standard voltages	See price list	See price list	See price list	See price list	See price list	See price list	See price list
RAC 24 <sup>2)</sup>	104438	104442	104446	104450	104454	104458	104462
RAC 48 <sup>3)</sup>	104439	104443	104447	104451	104455	104459	104463
RAC 120 <sup>4)</sup>	104440	104444	104448	104452	104456	104460	104464
RAC 240 <sup>5)</sup>	104441	104445	104449	104453	104457	104461	104465
AC	DILMF65 (...)	DILMF80 (...)	DILMF95 (...)	DILMF115 (...)	DILMF150 (...)		
	Article no. <sup>1)</sup>	Article no. <sup>1)</sup>	Article no. <sup>1)</sup>	Article no. <sup>1)</sup>	Article no. <sup>1)</sup>		
Standard voltages	See price list	See price list	See price list	See price list	See price list		
RAC 24 <sup>2)</sup>	104466	104470	104474	104478	104482		
RAC 48 <sup>3)</sup>	104467	104471	104475	104479	104483		
RAC 120 <sup>4)</sup>	104468	104472	104476	104480	104484		
RAC 240 <sup>5)</sup>	104469	104473	104477	104481	104485		

## Notes

<sup>1)</sup> The article no. results from combining the part no. and the actuating voltage.

<sup>2)</sup> 24 - 24 V

<sup>3)</sup> 42 - 48

<sup>4)</sup> 100 - 120

<sup>5)</sup> 190 - 240



HPL05081EN

**DILM**

Complete comfort devices	DILM250 /22(...)	DILM300A /22(...)	DILM400 /22(...)	DILM500 /22(...)	DILM580 /22(...)	DILM650 /22(...)	DILM750 /22(...)	DILM820 /22(...)	DILM1000 /22(...)
	Article no. <sup>1)</sup>	Article no. <sup>1)</sup>	Article no. <sup>1)</sup>	Article no. <sup>1)</sup>	Article no. <sup>1)</sup>	Article no. <sup>1)</sup>	Article no. <sup>1)</sup>	Article no. <sup>1)</sup>	Article no. <sup>1)</sup>
Voltage variants	See price list	See price list	See price list	See price list	See price list	See price list	See price list	See price list	See price list
RDC 48 <sup>2)</sup>	208199	139554	208207	208211	–	–	–	–	–
RA 110 <sup>3)</sup>	208200	139555	208208	208212	208215	208218	208221	208224	–
RA 250 <sup>4)</sup>	208201	139556	208209	208213	208216	208219	208222	208225	267214
RAC 500 <sup>5) 6)</sup>	208202	139557	208210	208214	208217	208220	208223	208226	–

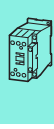

Complete units Standard	DILM250 -S/22(...)	DILM300A -S/22(...)	DILM400 -S/22(...)	DILM500 -S/22(...)
	Article no. <sup>1)</sup>	Article no. <sup>1)</sup>	Article no. <sup>1)</sup>	Article no. <sup>1)</sup>
Voltage variants	See price list	See price list	See price list	See price list
110-120V 50/60Hz	274189	139558	274195	274198
220-240V 50/60Hz	274190	139559	274196	274199

Electronic module, incl. coil, for comfort model	DILM250-XSP/E(...)	DILM500-XSP/E(...)	DILM1000-XSP/E(...)
	Article no. <sup>1)</sup>	Article no. <sup>1)</sup>	Article no. <sup>1)</sup>
Voltage variants	See price list	See price list	See price list
RDC 48 <sup>2)</sup>	208250	208254	–
RA 110 <sup>3)</sup>	208251	208255	289146
RA 250 <sup>4)</sup>	208252	208256	289145
RAC 500 <sup>5) 6)</sup>	208253	208257	289147

Electronic module, incl. coil, for standard model	DILM250-S-XSP/E(...)	DILM500-S-XSP/E(...)
	Article no. <sup>1)</sup>	Article no. <sup>1)</sup>
Voltage variants	See price list	See price list
110-120V 50/60Hz	274201	274204
220-240V 50/60Hz	274202	274205

**Notes**

- <sup>1)</sup> The article no. results from combining the part no. and the voltage variant.
- <sup>2)</sup> 24 – 48 V DC
- <sup>3)</sup> 48 – 110 V 40 – 60 Hz/48 – 110 V DC
- <sup>4)</sup> 110 – 250 V 40 – 60 Hz/110 – 250 V DC
- <sup>5)</sup> 250 – 500 V 40 – 60 Hz
- <sup>6)</sup> DC on request

## Engineering

The diagrams show the closing and opening travel of the contacts at no load.

	N/O	NC		
			x1	x2
<b>DILE AC</b>	N/O		1.9	2.8
	NC		0.95	2.8
...DILE	N/O		1.9	2.8
	NC		0.9	2.8
...DDILE	NO early-make		1.06	2.9
	Late-break N/C contact		1.86	2.9
	N/O		1.9	2.8
	NC		0.9	2.8
<b>DILE DC</b>	N/O		1.9	2.85
	NC		0.95	2.85
DILE...	N/O		1.9	2.8
	NC		0.9	2.8
...DDILE	NO early-make		1.06	2.9
	Late-break N/C contact		1.86	2.9
	N/O		1.9	2.8
	NC		0.9	2.8
<b>DILA-AC</b>	N/O		3.3	4.5
	NC		1.0	4.5
DILA-XHI	N/O		3.2	4.5
	NC		1.6	4.5
DILA-XHIV	NO early-make		2.0	4.5
	Late-break N/C contact		2.8	4.5
	N/O		3.2	4.5
	NC		1.6	4.5
<b>DILA-DC</b>	N/O		2.1	2.9
	NC		0.7	2.9
DILA-XHI	N/O		2.3	2.9
	NC		0.7	2.9
DILA-XHIV	NO early-make		1.1	2.9
	Late-break N/C contact		1.9	2.9
	N/O		2.3	2.9
	NC		0.7	2.9
<b>DILM7/9 AC</b>	N/O		3.3	4.5
	NC		1.0	4.5
DILM32-XHI, DILA-XHI	N/O		3.2	4.5
	NC		1.6	4.5
DILA-XHIV	NO early-make		2.0	4.5
	Late-break N/C contact		2.8	4.5
	N/O		3.2	4.5
	NC		1.6	4.5
<b>DILM7/9 DC</b>	N/O		2.1	2.9
	NC		0.7	2.9
DILM32-XHI, DILA-XHI	N/O		2.3	2.9
	NC		0.7	2.9
DILA-XHIV	NO early-make		1.1	2.9
	Late-break N/C contact		1.9	2.9
	N/O		2.3	2.9
	NC		0.7	2.9
<b>DILM12/15/P20 AC</b>	N/O		3.3	4.5
	NC		1.0	4.5
DILM32-XHI, DILA-XHI	N/O		3.2	4.5
	NC		1.6	4.5
DILA-XHIV	NO early-make		2.0	4.5
	Late-break N/C contact		2.8	4.5
	N/O		3.2	4.5
	NC		1.6	4.5
<b>DILM12/15/P20 DC</b>	N/O		3.3	4.4
	NC		1.0	4.4
DILM32-XHI, DILA-XHI	N/O		3.2	4.4
	NC		1.6	4.4

The diagrams show the closing and opening travel of the contacts at no load.

	N/O	NC		
			x1	x2
DILA-XHIV	NO early-make		2.0	4.4
	Late-break N/C contact		2.8	4.4
	N/O		3.2	4.4
	NC		1.6	4.4
<b>DILM17/25/32/P32/P45</b>	N/O		4.0	6.0
	Auxiliary N/C		1.8	6.0
	Auxiliary N/O		3.2	6.0
DILM32-XHI, DILA-XHI	N/O		3.2	6.0
	NC		1.6	6.0
DILA-XHIV	NO early-make		2.0	6.0
	Late-break N/C contact		2.8	6.0
	N/O		3.2	6.0
	NC		1.6	6.0
<b>DILM40/50/65/P63/P80</b>	N/O		5.1	7.5
DILM150-XHI	N/O		5.7	7.5
	NC		3.9	7.5
DILM150-XHIV	NO early-make		3.8	7.5
	Late-break N/C contact		5.4	7.5
	N/O		5.7	7.5
	NC		3.9	7.5
DILM1000-XHI	N/O		5.5	7.5
	NC		3.6	7.5
DILM1000-XHIV	NO early-make		4.1	7.5
	Late-break N/C contact		5.0	7.5
<b>DILM80/95/115/150/170/P125/P160/P200</b>	N/O		8.0	11
DILM150-XHI	N/O		9.2	11
	NC		7.4	11
DILM150-XHIV	NO early-make		7.3	11
	Late-break N/C contact		8.9	11
	N/O		9.2	11
	NC		7.4	11
DILM1000-XHI	N/O		9.0	11
	NC		7.1	11
DILM1000-XHIV	NO early-make		7.6	11
	Late-break N/C contact		8.5	11
<b>DILM185A/225A</b>	N/O		10.0	13.0
DILM1000-XHI	N/O		10.0	13.0
	NC		8.1	13.0
DILM1000-XHIV	NO early-make		8.4	13.0
	Late-break N/C contact		9.5	13.0
<b>DILM250/300A</b>	N/O		10.1	13.1
DILM820-XHI	N/O		10.3	13.1
	NC		8.4	13.1
DILM820-XHIV	NO early-make		8.7	13.1
	Late-break N/C contact		9.8	13.1
<b>DILM400/500/570</b>	N/O		8.9	13.1
DILM820-XHI	N/O		10.3	13.1
	NC		8.4	13.1
DILM820-XHIV	NO early-make		8.7	13.1
	Late-break N/C contact		9.8	13.1
<b>DILM580/650/750/820</b>	N/O		2.0	4.1
DILM820-XHI	N/O		7.4	10.5
	NC		5.5	10.5
DILM820-XHIV	NO early-make		6.0	10.5
	Late-break N/C contact		6.8	10.5
<b>DILM1000/1600, DILH1400/2000/2200/2600</b>	N/O		2.0	4.1
DILM820-XHI	N/O		7.4	10.5
	NC		5.5	10.5
DILM820-XHIV	NO early-make		6.0	10.5
	Late-break N/C contact		6.8	10.5

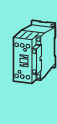

Components	Contactor selection				
	With top mounting auxiliary contacts	With side mounting auxiliary contacts	With overload relay	With parallel connector	Insulated enclosures
Part no.					
DILE...(-G)(-C)	—	—	—	—	CI-K1-95-TS
DILE...(-G)(-C)	•	—	—	—	CI-K2-145-TS
DILE...(-G)	•	—	•	—	CI-K2-145-AD
DILE...(-G)	—	—	—	•	CI-K2-100-TS
DILE...(-G)	•	—	—	•	CI-K2-145-TS
DILM7 to DILM15	•	—	—	—	CI-K2-145-TS
DILM7 to DILM15	•	—	•	—	CI-K3-160-TS
DILM17 to DILM32	—	—	—	—	CI-K2-145-TS
DILM17 to DILM32	•	—	•	—	CI23E-150
DILM40 to DILM65	—	•	—	—	CI-K3-160-TS
DILM40 to DILM65	•	•	•	—	CI43E-150
DILM80 to DILM170	•	•	—	—	CI43E-200
DILM80 to DILM170	•	•	•	—	CI44E-200
DILM185A	—	•	—	—	CI48-250
DILM225A	—	•	—	—	CI48-250
DILM250	—	•	—	—	CI48-250
DILM300A	—	•	—	—	CI48-250
DILM400	—	•	—	—	CI48-250
DILM500	—	•	—	—	CI48-250
DILM580	—	•	—	—	CI48-250
DILM650	—	•	—	—	CI48-250
DILM750	—	•	—	—	CI48-250
DILM820	—	•	—	—	CI48-250
DIULE...	•	—	—	—	CI-K3-125-TS
DIULE...	•	—	•	—	CI-K3-125-TS
DIULM7 to DIULM12	•	—	—	—	CI-K4-160-TS
DIULM17 to DIULM32	•	—	—	—	CI23E-150
DIULM40 to DIULM65	•	—	—	—	CI43E-200
SDAINLEM...	•	—	—	—	CI-K5-125-TS CI-K5-125-M
SDAINLM12 to SDAINLM22	•	—	—	—	CI-K5-160-TS
SDAINLM30 to SDAINLM65	•	—	—	—	CI23E-150
SDAINLM70 to SDAINLM115	•	—	—	—	CI43E-200

Notes	CI-K small enclosure	→ Chapter 20	Insulated PE, N or PEN terminal for enclosure CI-K	→ Chapter 20
	Terminal for CI-K enclosure	→ Chapter 20		
	CI enclosure	→ Chapter 20		



**Rating data for approved types**



Maximum alternating current-motor rating  
Single-phase

GENERAL USE

Maximum motor-rated current  
I<sub>th</sub>  
Open/enclosed

**Contactors**

NEMA size

Single-phase		3-phase				A	Part no.	
115 V 120 V HP	230 V 240 V HP	200 V 208 V HP	230 V 240 V HP	460 V 480 V HP	575 V 600 V HP			
1/2	1 1/2	2	3	5	5	15/13.5	<b>DILEM(4)</b>	00
1/4	1	1 1/2	2	3	5	20	<b>DILM7-...(...)</b>	00
1/2	1 1/2	3	3	5	7 1/2	20	<b>DILM9-...(...)</b>	00
1	2	3	3	10	10	20	<b>DILM12-...(...)</b>	0
1	3		5	10	10	20	<b>DILM15-...(...)</b>	0
2	3	5	7 1/2	10	15	35	<b>DILM17-...(...)</b>	0
2	5	7 1/2	7 1/2	15	20	35	<b>DILM25-...(...)</b>	1
3	5	10	10	20	25	40	<b>DILM32-...(...), DILM38-...(...)</b>	1
3	7 1/2	10	15	30	40	55	<b>DILM40(...)</b>	2
3	10	15	20	40	50	65	<b>DILM50(...)</b>	2
5	15	20	25	40	60	80	<b>DILM65(...), DILM70(...)</b>	2
7 1/2	15	25	30	60	75	125	<b>DILM80(...)</b>	3
7 1/2	15	25	40	75	100	125	<b>DILM95(...)</b>	3
10	25	40	50	100	125	160	<b>DILM115(...)</b>	4
15	30	40	60	125	125	160	<b>DILM150(...), DILM170(...)</b>	4
-	-	50	60	125	150	225	<b>DILM185(...)</b>	4
-	-	60	75	150	200	250	<b>DILM225(...)</b>	4
-	-	75	100	200	250	350	<b>DILM250(...)</b>	5
-	-	100	125	250	300	350	<b>DILM300(...)</b>	5
-	-	125	150	300	400	450	<b>DILM400(...)</b>	5
-	-	150	200	400	500	550	<b>DILM500(...)</b>	6
-	-	200	200	400	600	630	<b>DILM580(...)</b>	6
-	-	200	250	500	600	700	<b>DILM650(...)</b>	6
-	-	250	300	600	700	800	<b>DILM750(...)</b>	6
-	-	290	350	700	860	850	<b>DILM820(...)</b>	6
-	-	350	400	800	1000	1000	<b>DILM1000(...)</b>	7
-	-	560	640	1200	1300	1600	<b>DILM1600(...)</b>	8

Further approvals → 5/85

- Elevator control
- Refrigeration control
- Resistance air heating
- Incandescent lamps
- Electrical discharge lamps
- Capacitive switching

**Approved rating data  
UL - File No. E29184  
for auxiliary contacts**



Part no.	Pilot Duty		General Use			
	AC	DC	AC V	A	DC V	A
<b>DIL(E)EM-10(-01) DILER-40(31)(22) ...(D)DILE</b>	A600	P300	600	10	250	0.5
<b>DILM7-10(-01) To DILM32-10(-01) DILA...</b>	A600	P300	600	15	250	1
<b>DILA-XHI... DILM32-XHI...</b>	A600	P300	600	15	250	1
<b>DILM...-XHI11-SI DILM...-XHI11-SA DILM...-XHI11V-SI</b>	A600	P600	600	10	-	-

Special purpose rating



	DIL	M7	M9	M12	M15	M17	M25 MP32 MP45	M32	M40 MP63	M50 MP80	M65 M72	M80 MP125	M95 MP160	M115	M150 M170 MP200
<b>Electrical discharge lamps (ballast)</b>															
480V 60Hz 3phase, 277V 60Hz 1phase	A	12	18	20	20	27	35	40	63	79	88	85	100	136	160
600V 60Hz 3phase, 347V 60Hz 1phase	A	12	18	20	20	27	35	40	63	79	88	85	100	136	160
<b>Incandescent lamps (Tungsten)</b>															
480V 60Hz 3phase, 277V 60Hz 1phase	A	8	11	14	14	23	32	40	55	74	88	85	100	136	160
600V 60Hz 3phase, 347V 60Hz 1phase	A	8	11	14	14	23	32	40	55	74	88	85	100	136	160
<b>Resistance air heating</b>															
480V/60Hz 3phase, 277V/60Hz 1phase	A	12	18	20	20	27	35	40	63	79	88	94	110	136	160
600V/60Hz 3phase, 347V/60Hz 1phase	A	12	18	20	20	27	35	40	63	79	88	94	110	136	160
<b>Refrigeration control (CSA only)</b>															
LRA 480V 60Hz 3phase	A	60	60	60	60	240	240	240	270	270	270	540	540	540	540
LRA 600V 60Hz 3phase	A	60	60	60	60	180	180	180	270	270	270	420	420	540	540
480V 60Hz 3phase	A	6	7.5	10	10	23	32	40	26	36	45	63	70	84	90
600V 60Hz 3phase	A	6	7.5	10	10	17	24	30	26	36	45	63	70	84	90
<b>Elevator control</b>															
200V 60Hz 3phase	HP (A)	¾ (3.7)	2 (7.8)	2 (7.8)	2 (7.8)	3 (11)	3 (11)	7½ (25.3)	7½ (25.3)	10 (32.2)	10 (32.2)	20 (62.1)	20 (62.1)	30 (92)	30 (92)
240V 60Hz 3phase	HP (A)	1½ (6.0)	2 (6.8)	2 (6.8)	3 (9.6)	3 (9.6)	5 (15.2)	7½ (22)	10 (28)	15 (42)	15 (42)	25 (68)	30 (80)	40 (104)	40 (104)
480V 60Hz 3phase	HP (A)	2 (3.4)	3 (4.8)	7½ (11)	7½ (11)	7½ (11)	10 (14)	20 (27)	25 (34)	30 (40)	30 (40)	50 (65)	60 (77)	75 (96)	75 (96)
600V 60Hz 3phase	HP (A)	3 (3.9)	5 (6.1)	7½ (9.6)	7½ (9.6)	10 (11)	15 (17)	20 (22)	30 (32)	40 (41)	40 (41)	60 (62)	75 (77)	100 (99)	100 (99)

	DIL	K12	K20	K25	K33	K50
<b>Capacitor Switching</b>						
240V 60Hz 3phase	A	18	28	36	48	72
480V 60Hz 3phase	A	18	28	36	48	72
600V 60Hz 3phase	A	14.4	28	38.4	48	72
240V 60Hz 3phase	kvar	7.5	12	15	20	30
480V 60Hz 3phase	kvar	15	20	30	40	60
600V 60Hz 3phase	kvar	15	30	40	50	75

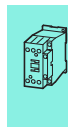

UL/CSA Short circuit current rating

**DILM****Short circuit current rating (SCCR)**

Contactor	Basic Rating			480 V High Fault				600 V High Fault			
	kA	Max. fuse A	Max. CB A	kA	Max. fuse A	kA	Max. CB A	kA	Max. fuse A	kA	Max. CB A
DILM7-...(…)	5	45	60	100	20 Class J	-	Fuse only	30	25	-	Fuse only
DILM9-...(…)	5	45	60	100	20 Class J	-	Fuse only	30	25	-	Fuse only
DILM12-...(…)	5	45	60	100	20 Class J	-	Fuse only	30	25	-	Fuse only
DILM15-...(…)	5	45	60	100	20 Class J	-	Fuse only	30	25	-	Fuse only
DILM17-...(…)	5	125	125	100	70 Class J	10	50	10	125	10	50
DILM25-...(…)	5	125	125	100	100 Class J	10	50	10	125	10	50
DILM32-...(…)	5	125	125	100	125 Class J	10	50	10	125	10	50
DILM38-...(…)	5	125	125	100	125 Class J	10	50	10	125	10	50
DILM40(…)	10	250	250	100	150 Class J	65	100	30	250	30	250
DILM50(…)	10	250	250	100	150 Class J	65	100	30	250	30	250
DILM65(…)	10	250	250	100	150 Class J	65	100	30	250	30	250
DILM72(…)	10	250	250	100	150 Class J	65	100	30	250	30	250
DILM80(…)	10	600	600	100	300 Class J	65	250	30	300	30	350
DILM95(…)	10	600	600	100	300 Class J	65	250	30	300	30	350
DILM115(…)	10	600	600	100	300 Class J	65	250	30	300	30	350
DILM150(…)	10	600	600	100	300 Class J	65	250	30	300	30	350
DILM170(…)	10	600	600	100	300 Class J	65	250	30	300	30	350
DILM185(…)	18	700	600	-	CB only	65	250	-	-	-	-
DILM225(…)	18	700	600	-	CB only	65	250	-	-	-	-
DILM250(…)	18	700	600	-	CB only	65	250	-	-	-	-
DILM300(…)	30	800	600	-	CB only	42	600	30	800	30	600
DILM400(…)	30	800	600	-	CB only	42	600	30	800	30	600
DILM500(…)	30	800	600	-	CB only	42	600	30	800	30	600
DILM570(…)	30	800	600	-	CB only	42	600	30	800	30	600
DILM580(…)	30	2000	1200	85	2000	85	1200	85	2000	85	1200
DILM650(…)	30	2000	1200	85	2000	85	1200	85	2000	85	1200
DILM750(…)	42	2000	1200	85	2000	85	1200	85	2000	85	1200
DILM820(…)	42	2000	1200	85	2000	85	1200	85	2000	85	1200
DILM1000(…)	85	2000	1200	85	2000	85	1200	85	2000	85	1200
DILM1600(…)	85	2000	-	85	2000	-	-	85	2000	85	-

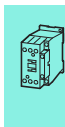

Rating data

Single-phase rating AC-1

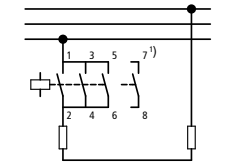

Voltage in V			Max. upstream fuse gG/gL	Rated operational current $I_e = I_{th}$ or $I_{the}$ A
220	380	660		
230	400	690		
240	440			
kW	kW	kW	A	A

Three-phase rating AC-1

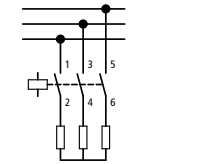

Voltage in V			Max. upstream fuse gG/gL	Rated operational current $I_e = I_{th}$ or $I_{the}$ A
220	380	660		
230	400	690		
240	440			
kW	kW	kW	A	A

Three-phase rating AC-1

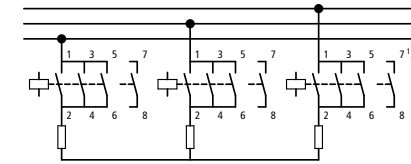

Voltage in V			Max. upstream fuse gG/gL	Rated operational current $I_e = I_{th}$ or $I_{the}$ A
220	380	660		
230	400	690		
240	440			
kW	kW	kW	A	A

Open version

Single-phase rating AC-1					Three-phase rating AC-1					Three-phase rating AC-1				
10	18	31	50	50	7	13	20	20	20	18	31	54	50	50
10	18	31	50	50	7	13	20	20	20	18	31	54	50	50
12	21	37	63	60	-	-	-	-	-	21	37	65	63	60
10	18	31	-	50	7	13	22	-	20	18	31	54	-	50
13	22	38	-	60	-	-	-	-	-	22	38	65	-	60
18	32	55	-	88	13	22	38	-	35	32	55	95	-	88
21	36	63	-	100	14	25	43	-	40	36	63	109	-	100
26	45	78	-	125	18	31	54	-	50	45	78	136	-	125
34	59	102	-	163	24	41	71	-	65	59	102	176	-	163
42	72	125	-	200	29	50	87	-	80	72	125	217	-	200
47	81	141	-	225	33	56	98	-	90	81	141	244	-	225
57	99	172	-	275	40	69	119	-	110	100	172	299	-	275
68	117	204	-	325	47	81	141	-	130	118	203	353	-	325
84	144	251	-	400	58	100	174	-	160	145	250	434	-	400
101	175	317	-	460	70	120	220	-	185	175	302	549	-	460
144	248	431	800	688	100	172	299	315	275	262	453	786	-	688
165	284	494	800	788	114	197	342	315	315	300	519	900	-	788
172	297	516	1000	825	120	206	357	400	330	333	576	1000	-	875
183	316	548	1000	875	126	219	380	400	350	381	658	1143	-	1000
261	451	784	1250	1250	181	313	543	500	500	476	825	1429	-	1250
366	632	1097	-	1750	253	438	760	800	700	667	1152	2000	-	1750
418	722	1254	-	2000	290	500	869	800	800	762	1316	2286	-	2000
444	767	1332	-	2125	308	531	923	1000	850	810	1400	2429	-	2125
470	812	1411	-	2250	326	563	977	1000	900	857	1480	2572	-	2250
523	903	1568	-	2500	362	625	1086	1000	1000	953	1646	2858	-	2500
732	1264	2195	-	3500	507	875	1520	-	1400	1334	2300	4000	-	3500
1045	1805	3135	-	5000	724	1251	2172	-	2000	1905	3290	5716	-	5000
1150	1985	3449	-	5500	796	1376	2389	-	2200	2095	3619	6288	-	5500
1358	2346	4075	-	6500	941	1626	2827	-	2600	2476	4277	7430	-	6500

Notes

<sup>1)</sup> Contact 7 – 8 only with DILEM4(-G), DILMP20...

Part no.	Ordering data	Required accessories:	Notes
		Paralleling links	
AC operated	Page	Part no.	
DILEM-10(...)	→ 5/4	P1DILEM	
DILEM-01(...)	→ 5/4	P1DILEM	
DILEM4(...)	→ 5/4	P1DILEM	
DILM7-...(...)	→ 5/18	DILM12-XP1	
DILMP20(...)	→ 5/36	DILM12-XP1	
DILM17-...(...)	→ 5/18	DILM32-XP1	
DILM25-...(...)	→ 5/18	DILM32-XP1	
DILM40(...)	→ 5/20	DILM65-XP1	
DILM50(...)	→ 5/20	DILM65-XP1	
DILM65(...)	→ 5/20	DILM65-XP1	
DILM80(...)	→ 5/20	DILM150-XP1	
DILM95(...)	→ 5/20	DILM150-XP1	
DILM115(...)	→ 5/20	DILM150-XP1	
DILM150(...)	→ 5/20	DILM150-XP1	
DILM170(...)	→ 5/20	DILM150-KP1	
DILM185A(...)	→ 5/32	DILM185-XP1	
DILM225A(...)	→ 5/32	DILM185-XP1	
DILM250(...)	→ 5/32	-	
DILM300A(...)	→ 5/32	-	
DILM400(...)	→ 5/32	-	
DILM500(...)	→ 5/32	-	
DILM580(...)	→ 5/32	-	
DILM650(...)	→ 5/32	-	
DILM750(...)	→ 5/32	-	
DILM820(...)	→ 5/32	-	
DILH1400(...)	→ 5/34	-	
DILH2000(...)	→ 5/34	-	
DILH2200(...)	→ 5/34	-	
DILH2600(...)	→ 5/34	-	

Accessories	Page
Auxiliary contact modules	→ 5/6
	→ 5/38
Set of paralleling links	→ 5/57
Enclosure	→ 5/67
Accessories	→ 5/56



**DILA (AC-15)**

Component lifespan (operations)  
 $I_e$  = Rated operational current

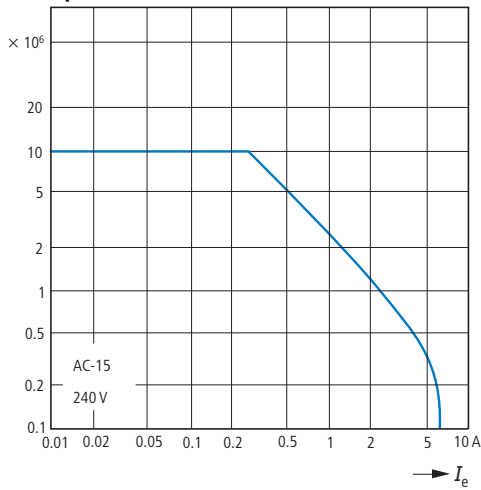

**DILA DC<sup>1)</sup>**

Component lifespan (operations)  
 $I_e$  = Rated operational current

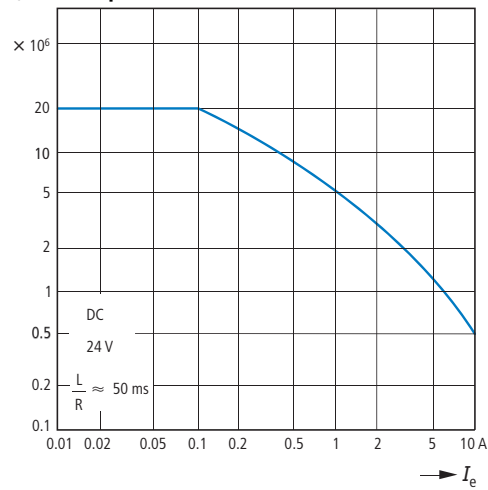

<sup>1)</sup> Three contacts in series

**DILER (AC-15)**

Component lifespan (operations)  
 $I_e$  = Rated operational current

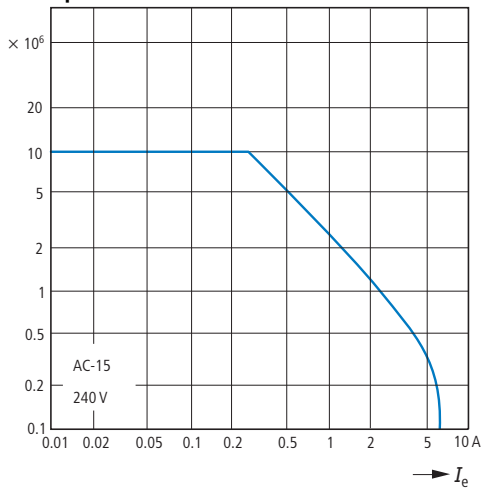

**Normal switching duty**

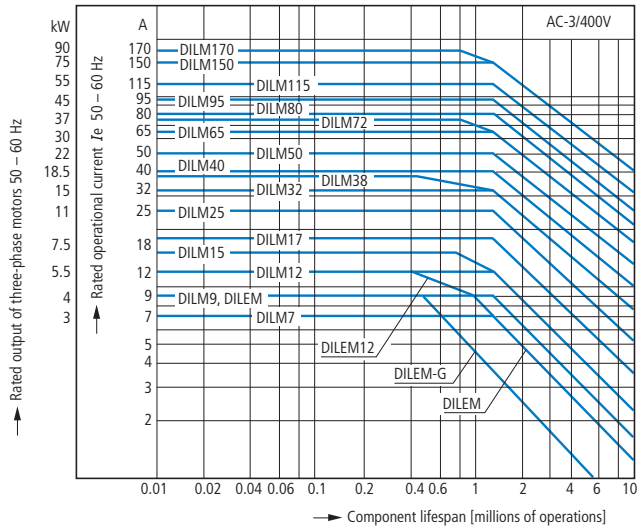

**Normal AC induction motor**

Operating characteristics

Make: from stop

Break: during run

Electrical characteristics:

Make: up to 6 X rated motor current

Break: 1 X rated motor current

Utilization category

100 % AC-3

Typical applications:

- |  |                 |                       |
|--|-----------------|-----------------------|
| Compressors  | Lifts           | Mixers                |
| Pumps  | Escalators      | Agitators             |
| Fan  | Conveyor belts  | Centrifuges           |
| Hinged flaps   | Bucket-elevator | Air conditioning sys- |
| General drives for manufacturing and processing machines |                 |                       |

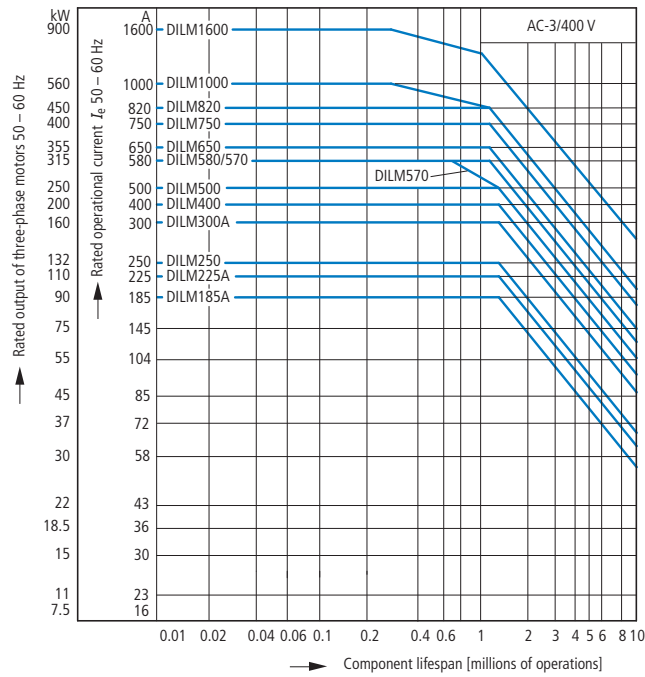
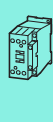

**Extreme switching duty**

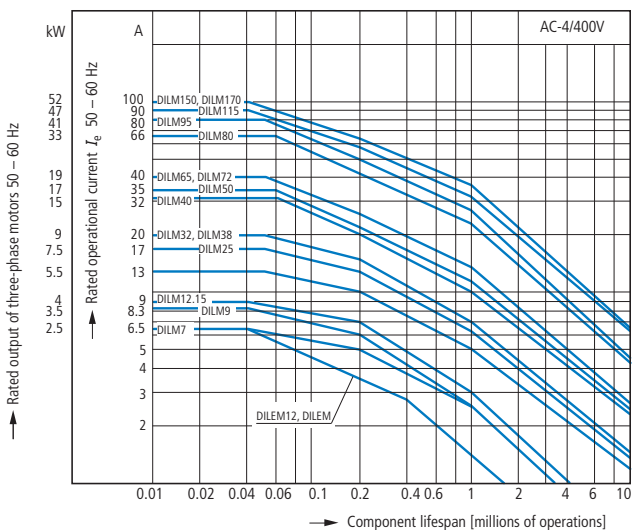

**Normal AC induction motor**

Operating characteristics

Inching, plugging, reversing

Electrical characteristics:

Make: up to 6 X rated motor current

Break: 6 X rated motor current

Utilization category

100 % AC-4

Typical applications:

- |   |              |             |
|---|--------------|-------------|
| Printing machines                                       | Wire-drawing | Centrifuges |
| Special drives on manufacturing and processing machines |              |             |

Extreme switching duty

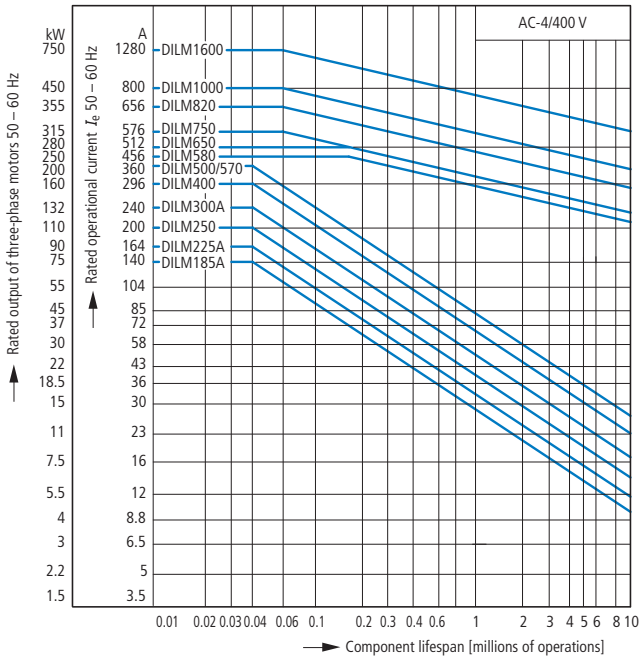

Normal AC induction motor

Operating characteristics

Inching, plugging, reversing

Electrical characteristics:

Make: up to 6 X rated motor current

Break: 6 X rated motor current

Utilization category

100 % AC-4

Typical applications:

Printing machines Wire-drawing machines Centrifuges

Special drives on manufacturing and processing machines

Switching conditions for 3 pole, non-motor loads

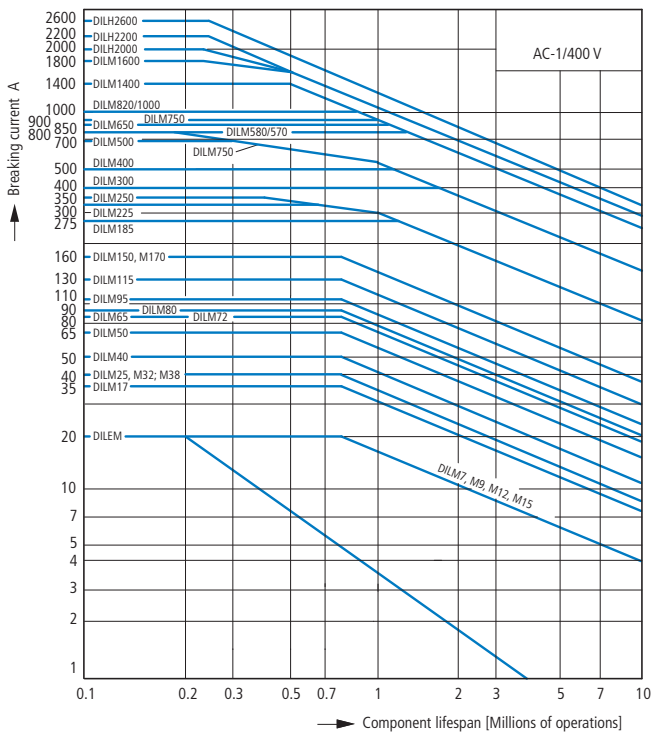

Operating characteristics

Non inductive and slightly inductive loads

Electrical characteristics:

Make: 1 X rated operational current

Break: 1 X rated operational current

Utilization category

100 % AC-1

Typical applications:

Electric heat

**Switching conditions for 4 pole, non-motor loads**

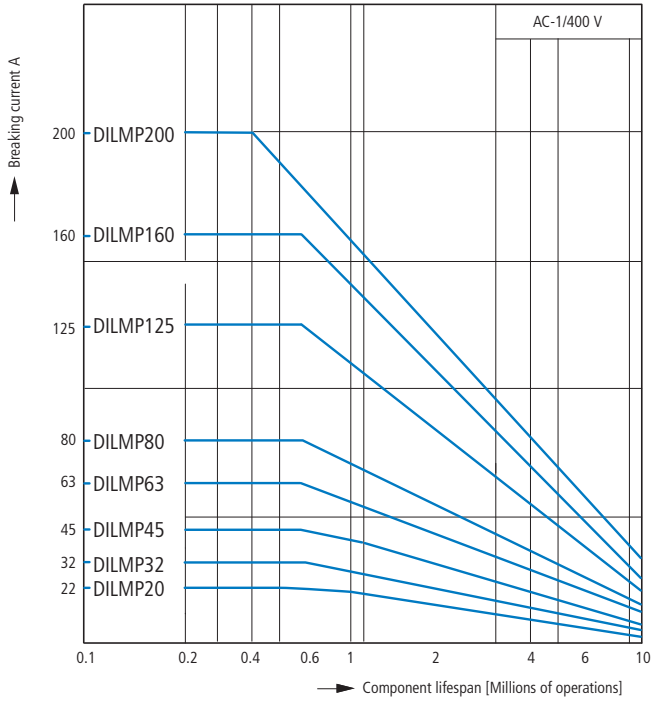

- Operating characteristics
  - Non inductive and slightly inductive loads
- Electrical characteristics:
  - Make: 1 X rated operational current
  - Break: 1 X rated operational current
- Utilization category
  - 100 % AC-1
- Typical applications:
  - Electric heat

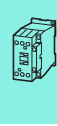

Short-time loading 3 pole

Time interval between two loads: 15 minutes

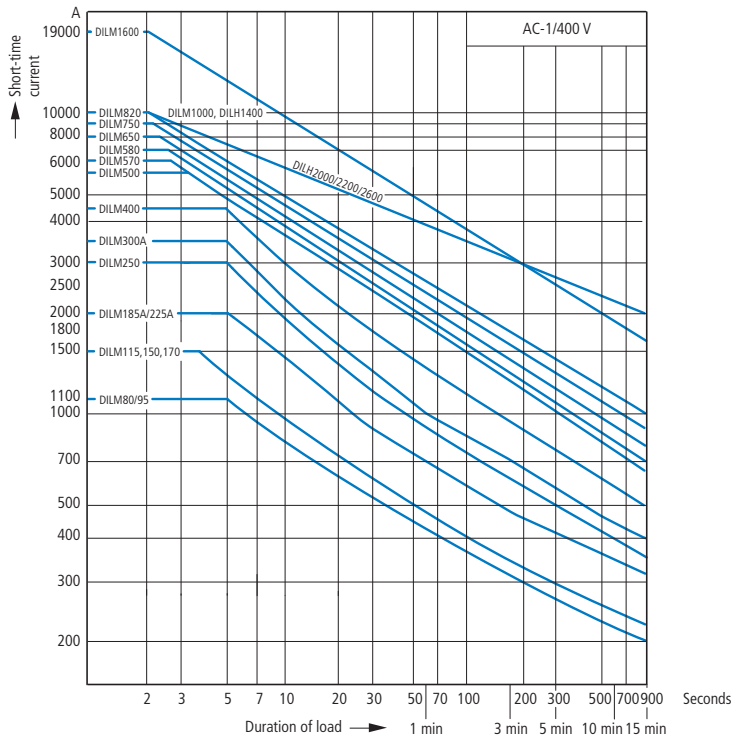
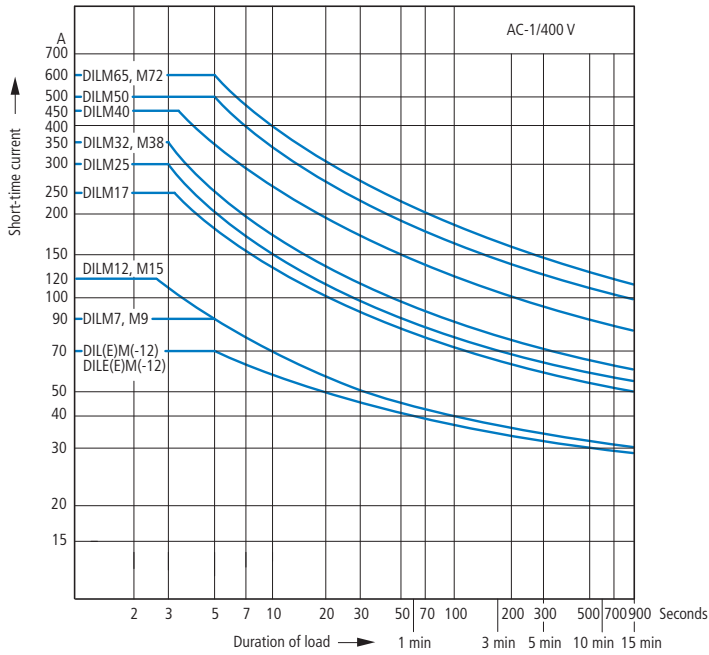

**Determination of the maximum operating frequency dependent on the rating and utilization category (recommended values) for 400 V**

$P_N$  = max. rated motor output (kW) of respective contactor according to → Page 5/18 and → Page 5/4  
S/h = max. operation per hour

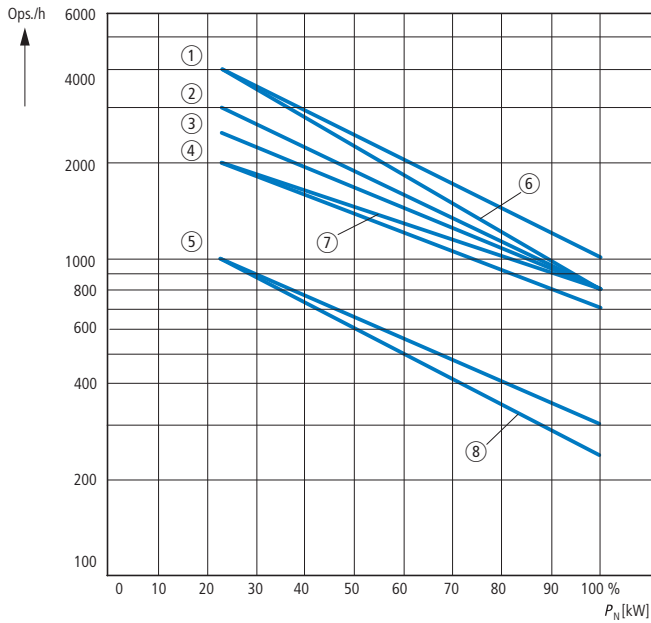

Part no.	Characteristic AC-1	AC-3	AC-2 AC-4
DILE(E)M(-12)	7	6	8
DILM7, 9, 12, 15	3	1	5
DILM17, 25, 32, 38	3	2	5
DILM40, 50, 65, 72	3	2	5
DILM80, 95, 115, 150, 170	3	4	5

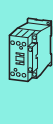

**Determination of the maximum operating frequency dependent on the rating and utilization category (recommended values)**

$P_N$  = max. rated motor output (kW) of respective contactor according to → Page 5/30 and → Page 5/34  
S/h = max. operation per hour

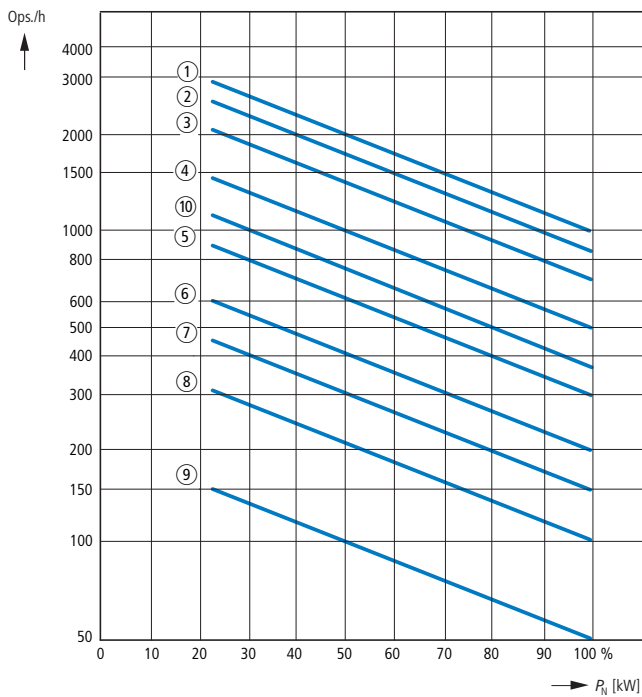

Part no.	Characteristic AC-1	AC-3	AC-4
DILM185A	2	1	8
DILM225A	2	1	8
DILM250	2	1	8
DILM300A	3	2	9
DILM400	3	2	9
DILM500	3	2	9
DILM580	3	4	7
DILM650	3	4	7
DILM750	3	4	7
DILM820	3	4	7
DILM1000	3	4	7
DILM1600	10	10	7
DILH1400	10	—	—
DILH2000	10	—	—
DILH2200	10	—	—
DILH2600	10	—	—

**DC current switching**

----- when necessary  
conductor to be  
supplied by customer

**DILEEM ... DILM700**

Without overload relay  
≤ 60 V DC

> 60 V DC

With overload relay  
> 60 V DC

1 pole

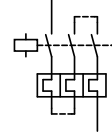

2 pole

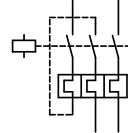

**DILEM4  
DILMP...**

1 pole

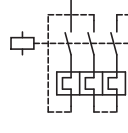
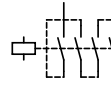

2 pole

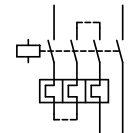

**Wiring, star-delta combination with DILM32-XTEY20**

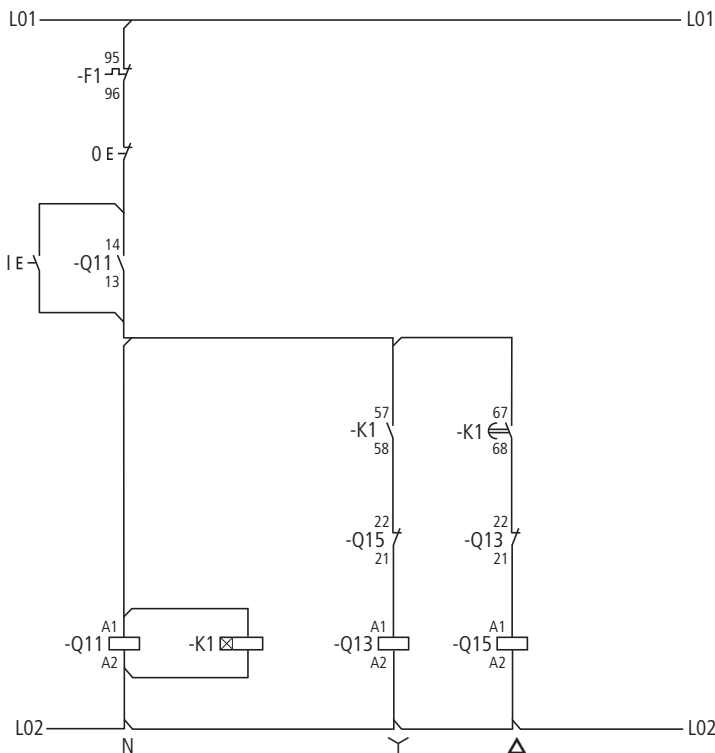

## DILER, DILA

## Technical data

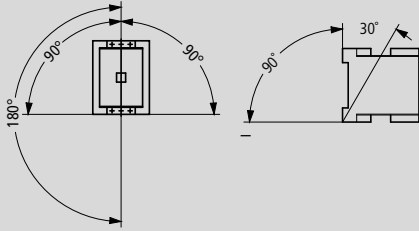
			DILA	DILA...XHI	DILER	DILE...	
<b>General</b>							
Standards			IEC/EN 60947, VDE 0660, UL, CSA				
Lifespan, mechanical							
AC operated	Operations	x 10 <sup>6</sup>	20	10	10	10	
DC operated	Operations	x 10 <sup>6</sup>	20	10	20	20	
Maximum operating frequency							
Maximum operating frequency	Operations/h		9000	9000	9000	9000	
Climatic proofing			Damp heat, constant, to IEC 60068-2-78; Damp heat, cyclic, to IEC 60068-2-30				
Ambient temperature							
Open		°C	-25...60	-25...60	-25...50	-25...50	
Enclosed		°C	-25...40	-25...40	-25...40	-25...40	
Ambient temperature for storage		°C	-40 - 80	-40 - 80			
Mounting position						Any, except vertically with terminals A1/A2 below	
Mechanical shock resistance (IEC/EN 60068-2-27)							
Half-sinusoidal shock 10 ms							
Basic devices with auxiliary contact module							
	N/O	g	7	7	10	10	
	NC	g	5	5	8	8	
Protection type			IP20	IP20	IP20	IP20	
Protection against direct contact when actuated from front (EN 50274)			Finger- and back-of-hand proof				
Weight							
AC operated		kg	0.23	0.05	0.17	–	
DC operated		kg	0.28	0.05	0.2	–	
Terminal capacity							
Screw terminals							
Solid		mm <sup>2</sup>	1 x (0.75 - 4) 2 x (0.75 - 2.5)	1 x (0.75 - 4) 2 x (0.75 - 2.5)	1 x (0.75 - 2.5) 2 x (0.75 - 2.5)	1 x (0.75 - 2.5) 2 x (0.75 - 2.5)	
Flexible with ferrule		mm <sup>2</sup>	1 x (0.75 - 2.5) 2 x (0.75 - 2.5)	1 x (0.75 - 2.5) 2 x (0.75 - 2.5)	1 x (0.75 - 1.5) 2 x (0.75 - 1.5)	1 x (0.75 - 1.5) 2 x (0.75 - 1.5)	
Solid or stranded		AWG	18 - 14	18 - 14	18 - 14	18 - 14	
Terminal screw			M3.5	M3.5	M3.5	M3.5	
Pozidriv screwdriver		Size	2	2	2	2	
Flat-blade screwdriver		mm	0.8 x 5.5 1 x 6	0.8 x 5.5 1 x 6	0.8 x 5.5 1 x 6	0.8 x 5.5 1 x 6	
Max. tightening torque		Nm	1.2	1.2	1.2	1.2	
Spring-loaded terminals							
Solid		mm <sup>2</sup>	1 x (0.75 - 2.5) 2 x (0.75 - 2.5)	1 x (0.75 - 2.5) 2 x (0.75 - 2.5)	1 x (1 - 2.5) 2 x (1 - 2.5)	1 x (1 - 2.5) 2 x (1 - 2.5)	
Flexible with ferrule		mm <sup>2</sup>	1 x (0.75 - 1.5) 2 x (0.75 - 1.5)	1 x (0.75 - 1.5) 2 x (0.75 - 1.5)	1 x (1 - 2.5) 2 x (1 - 2.5)	1 x (1 - 2.5) 2 x (1 - 2.5)	
Flexible without ferrule DIN 46228		mm <sup>2</sup>	1 x (0.75 - 2.5) 2 x (0.75 - 2.5)	1 x (0.75 - 1.5) 2 x (0.75 - 1.5)	–	–	
Solid or stranded		AWG	18 - 14	18 - 14	1 x (16 - 14) 2 x (16 - 14)	1 x (16 - 14) 2 x (16 - 14)	
Flat-blade screwdriver		mm	0.6 x 3.5	0.6 x 3.5	0.6 x 3.5	0.6 x 3.5	

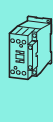



## DILER, DILA

			DILA	DILA...XHI	DILER	DILE...
<b>Contacts</b>						
Interlocked opposing contacts to EN 60947-4-1, Annex L, including auxiliary contact module			Yes	Yes	Yes	Yes
Rated impulse withstand voltage	$U_{imp}$	V AC	6000	6000	6000	6000
Overtoltage category/degree of pollution			III/3	III/3	III/3	III/3
Rated insulation voltage	$U_i$	V AC	690	690	690	690
Rated operating voltage	$U_e$	V AC	690	500	600	600
Safe isolation according to EN 61140						
Between coil and auxiliary contacts		V AC	400	400	300	300
Between the auxiliary contacts		V AC	400	400	300	300
Rated operational current						
AC-15						
220/240 V	$I_e$	A	4	4	6	4
380/415 V	$I_e$	A	4	4	3	2
500 V	$I_e$	A	1.5	1.5	1.5	1.5
DC <sup>1)</sup>						
L/R ≤ 15 ms						
Contacts in series:						
1	24 V	A	10	10	2.5	2.5
1	60 V	A	6	6	–	–
2	60 V	A	10	10	2.5	2.5
1	110 V	A	3	3	–	–
3	110 V	A	6	6	1.5	1.5
1	220 V	A	1	1	–	–
3	220 V	A	5	5	0.5	0.5
L/R ≤ 50 ms						
Contacts in series:						
3	24 V	A	4	2.5	–	–
3	60 V	A	4	1	–	–
3	110 V	A	2	0.5	–	–
3	220 V	A	1	0.25	–	–
DC-13 (6xP)						
Contacts in series:						
3	24 V	A	2.5	2.5	–	–
3	60 V	A	1	1	–	–
3	110 V	A	0.5	0.5	–	–
3	220 V	A	0.25	0.25	–	–
Control circuit reliability (at $U_e = 24$ V DC, $U_{min} = 17$ V, $I_{min} = 5.4$ mA)	Fault probability	$\lambda$	<10 <sup>-9</sup> , < one failure in 100 million operations			
Conventional thermal current	$I_{th}$	A	16	16	10	10
Short-circuit strength without welding						
Maximum overcurrent protection device						
220/240 V		PKZM 0	4	–	4	4
380/415 V		PKZM 0	4	–	4	4
Short-circuit protection rating maximum fuse <sup>2)</sup>						
500 V		A gG/ gL	10	10	6	6
500 V		A fast	–	–	10	10
Current heat loss at load of $I_{th}$						
AC operated		W	0.3	0.3	0.2	0.2
DC operated		W	0.3	0.3	0.3	0.3

## Notes

<sup>1)</sup> Switch-on and switch-off conditions based on DC-13, time constant as specified

<sup>2)</sup> See characteristic curve "Fuses" for time/current characteristics (please enquire)

## DILER, DILA

			DILA	DILA...XHI	DILER	DILE...
<b>Magnet systems</b>						
Voltage tolerance						
AC operated						
Single-voltage coil 50 Hz and dual-voltage coil 50 Hz, 60 Hz	Pick-up	x U <sub>c</sub>	0.8...1.1	–	0.8...1.1	–
Dual-frequency coil 50/60 Hz	Pick-up	x U <sub>c</sub>	0.8...1.1	–	0.85...1.1	–
DC operated <sup>1)</sup>						
Starting voltage	Pick-up	x U <sub>c</sub>	0.8...1.1	–	0.85...1.3	–
At 24 V: without auxiliary contact module (40 °C)	Pick-up	x U <sub>c</sub>	0.7 - 1.3	–	0.7 - 1.3	–
Power consumption						
50 Hz	Pick-up	VA	24	–	25	–
50 Hz	Sealing	VA	3.4	–	4.6	–
50 Hz	Sealing	W	1.2	–	1.3	–
60 Hz	Pick-up	VA	30	–	25	–
60 Hz	Sealing	VA	4.4	–	4.6	–
60 Hz	Sealing	W	1.4	–	1.3	–
50/60 Hz	Pick-up	VA	27 25	–	30 29	–
50/60 Hz	Sealing	VA	4.2 3.3	–	5.4 3.9	–
50/60 Hz	Sealing	W	1.4 1.2	–	1.6 1.1	–
DC operated	Pick-up = sealing	W	3	–	2.6	–
Duty factor		% DF	100	–	100	–
Changeover times at 100 % U <sub>c</sub> (recommended values)						
AC operated closing delay		ms	15 - 21	–	14 - 21	–
AC operated normally open contact opening delay		ms	9 - 18	–	8 - 18	–
AC operated with auxiliary contact module, max. closing delay		ms	–	–	45	45
DC operated closing delay		ms	31	–	26 - 35	–
DC operated normally open contact opening delay		ms	12	–	15 - 25	–
DC operated with auxiliary contact module, max. closing delay		ms	–	–	70	70

## Notes

<sup>1)</sup> Smoothed DC, three-phase bridge rectifier or smoothed two-phase bridge rectifier



				ETS4-VS3	DILM32-XTE	CMD(24VDC) CMD(220-240VAC)
<b>General</b>						
Standards				IEC/EN 60947, VDE 0660, UL, CSA	DIN EN 61812, IEC/EN 60947, VDE 0660, UL, CSA	IEC/EN 60947 UL CSA
Lifespan, mechanical						
AC operated				c (contacts)	x 10 <sup>6</sup>	
				–	3	10
DC operated				c (contacts)	x 10 <sup>6</sup>	
				30	3	3
Maximum operating frequency						
DC operated				c (contacts)	x 10 <sup>6</sup>	
				72000	–	9000
Climatic proofing				Damp heat, constant, to IEC 60068-2-78 Damp heat, cyclic, to IEC 60068-2-30		
Ambient temperature						
Storage				°C		
				–	-40 - 80	-40 - 80
Open				°C		
				-25 - 60	-25 - 60	-25 - 50
Enclosed				°C		
				-25 - 45	-25 - 40	–
Mounting position				Any	As required, except suspended	Any
Mechanical shock resistance (IEC/EN 60068-2-27)						
Half-sinusoidal shock 20 ms						
N/O				g		
				10	–	–
Half-sinusoidal shock 10 ms						
N/O				g		
				–	6	4
NC				g		
				–	6	4
Protection type				IP20	IP20	IP20
Protection against direct contact when actuated from front (EN 50274)				Finger- and back-of-hand proof		
Weight				kg		
				0.09	0.08	0.1
Terminal capacity						
Solid				mm <sup>2</sup>		
				1 x (0.75 - 2.5) 2 x (0.75 - 2.5) <sup>1)</sup>	1 x (0.75 - 2.5) 2 x (0.75 - 1.5)	1 x (0.75...2.5) 2 x (0.75...1.5)
Flexible with ferrule				mm <sup>2</sup>		
				1 x (0.75 - 2.5) 2 x (0.75 - 1.5) <sup>1)</sup>	1 x (0.75 - 1.5) 2 x (0.75 - 1.5)	1 x (0.75...1.5) 2 x (0.75...1.5)
Solid or stranded				AWG		
				16 - 14	18 - 14	18...14
Terminal screw						
				M3.5	M3.5	M3.5
Pozidriv screwdriver				Size		
				2	2	2
Flat-blade screwdriver				mm		
				0.8 x 5.5 1 x 6	0.8 x 5.5 1 x 6	0.8 x 5.5 1 x 6
Max. tightening torque				Nm		
				1.2	1.2	1.2

**Notes**<sup>1)</sup> Use equal cross-sections only

			ETS4-VS3	DILM32-XTE	CMD(24VDC)	CMD(220-240VAC)
<b>Contacts</b>						
Rated impulse withstand voltage	$U_{imp}$	V AC	6000	6000	8000	4000
Overtoltage category/degree of pollution			III/2	III/3	III/3	III/3
Rated insulation voltage	$U_i$	V AC	440	600	100	250
Rated operating voltage	$U_e$	V	440 AC	400 AC	24 DC	250 AC
Rated operational current						
AC-15						
220/240 V	$I_e$	A	2	3	–	–
380/415 V	$I_e$	A	2	–	–	–
DC-13 <sup>1)</sup>						
DC-13 L/R ≤ 15 ms						
Contacts in series:						
1	24 V	A	2.6	1	–	–
1	60 V	A	1	0.2	–	–
1	110 V	A	0.6	0.2	–	–
1	220 V	A	0.2	0.1	–	–
DC-13 L/R ≤ 50 ms						
Contacts in series:						
1	24 V	A	2	1	–	–
1	60 V	A	0.6	0.2	–	–
1	110 V	A	0.08	0.2	–	–
1	220 V	A	0.08	0.1	–	–
DC-13 L/R ≤ 300 ms						
Contacts in series:						
1	24 V	A	0.6	1	–	–
1	60 V	A	0.2	0.2	–	–
1	110 V	A	0.08	0.2	–	–
1	220 V	A	0.03	0.1	–	–
Safe isolation according to EN 61140						
Between coil and auxiliary contacts		V AC	–	250	–	–
Between the auxiliary contacts		V AC	–	250	–	–
Control circuit reliability (at $U_e = 24$ V DC, $U_{min} = 17$ V, $I_{min} = 5.4$ mA)	Fault probability	$\lambda$	<10 <sup>-8</sup> , < one failure in 100 million operations	–	–	–
Conventional thermal current	$I_{th}$	A	6	4	–	–
Component lifespan						
AC-15						
230 V, $I_e = 0.1$ A	Switch operations	x 10 <sup>6</sup>	7	–	–	–
230 V, $I_e = 1.2$ A	Switch operations	x 10 <sup>6</sup>	1	–	–	–
Short-circuit rating without welding						
Short-circuit protection rating maximum fuse <sup>2)</sup>						
500 V		A gG/gL	–	4	2	2
500 V		A fast	4	–	–	–

**Notes**

- <sup>1)</sup> Switch-on and switch-off conditions based on DC-13, time constant as specified
- <sup>2)</sup> See transparent overlay "Fuses" for time/current characteristics (please enquire)

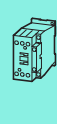

				ETS4-VS3	DILM32-XTE	CMD(24VDC) CMD(220-240VAC)
<b>Magnet systems</b>						
Voltage tolerance						
Starting voltage						
AC operated						
	Pick-up	$x U_c$	–	0.85 - 1.1	0.85 - 1.1	
DC operated <sup>1)</sup>						
	Pick-up	$x U_c$	0.85 - 1.2	0.7 - 1.2	0.85 - 1.1	
Power consumption						
AC operated						
	Sealing	VA	–	2	4	
AC operated						
	Sealing	W	–	1.8	4	
DC operated						
	Pick-up = sealing	W	0.6	–	4	
Duty factor						
		% DF	100	100	100	
Changeover times at 100 % $U_c$ (recommended values)						
DC operated closing delay						
		ms	7	–	–	
DC operated opening delay						
		ms	3	–	–	
Maximum operating frequency						
Max. operating frequency						
		Ops/h	–	3600	–	
6 A/250 V						
		Ops/h	–	360	–	
Minimum on duration						
On-delayed						
		ms	–	< 50	–	
Off-delayed						
		ms	–	< 200	–	
Repetition accuracy (with constant parameters)						
	Deviation	%	–	< 5	–	
Recovery time (after 100% time delay)						
		ms	–	70	–	
Contact changeover time						
DILM32-XTEE11/DILM32-XTED11						
	$t_u$	ms	–	10	–	
DILM32-XTEY20						
	$t_u$	ms	–	50	–	
CMD						
	$t_u$	ms	–	–	100 ± 20%	

**Notes**

<sup>1)</sup> Smoothed DC, three-phase bridge rectifier or smoothed two-phase bridge rectifier

## DILEEM, DILEM

			DILEEM DILEM DILEM12	DILEEM-G DILEM-G DILEM12-G	DILEM4	DILEM4-G
<b>General</b>						
Standards			IEC/EN 60947, VDE 0660, CSA, UL			
Lifespan, mechanical; Coil 50/60 Hz	at 50 Hz		7	–	7	–
Lifespan, mechanical	c (contacts)	x 10 <sup>6</sup>	10	20	20	–
Maximum operating frequency						
Mechanical		Ops/h	9000			
Electrical (Contactor without overload relay)			→ Characteristic curves Page 5/95			
Climatic proofing			Damp heat, constant, to IEC 60068-2-78 Damp heat, cyclic, to IEC 60068-2-30			
Ambient temperature						
Open		°C	-25 - 50			
Enclosed		°C	-25 - 40			
Mounting position			Any, except for vertically with terminals A1/A2 below			
Mechanical shock resistance (IEC/EN 60068-2-27)						
Half-sinusoidal shock 10 ms						
Basic device without auxiliary contact module						
Main circuit normally open contact		g	10			
Auxiliary contacts NC/Normally open contact		g	10/8	10/8	–	–
Basic devices with auxiliary contact module						
Main circuit normally open contact		g	10			
Auxiliary contacts Normally open contact/NC		g	20/20			
Protection type			IP20			
Protection against direct contact when actuated from front (EN 50274)			Finger- and back-of-hand proof			
Weight		kg	0.2	0.17	0.2	0.17
Terminal capacity: main and auxiliary contacts						
Solid		mm <sup>2</sup>	1 x (0.75 - 2.5) 2 x (0.75 - 2.5)			
Flexible with ferrule		mm <sup>2</sup>	1 x (0.75 - 1.5) 2 x (0.75 - 1.5)			
Solid or stranded		AWG	18 - 14			
Terminal screw			M3.5			
Pozidriv screwdriver		Size	2			
Flat-blade screwdriver		mm	0.8 x 5.5 1 x 6			
Max. tightening torque		Nm	1.2			
Terminal capacity springloaded terminals main and control circuits						
Solid		mm <sup>2</sup>	1 x (1 - 2.5) 2 x (1 - 2.5)			
Flexible with ferrule		mm <sup>2</sup>	1 x (1 - 2.5) 2 x (1 - 2.5)			
Flat-blade screwdriver		mm	0.6 x 3.5			

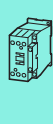

**DILEEM, DILEM**

				DILEEM DILEEM-G	DILEM DILEM-G	DILEM4	DILEM4-G	DILEM12 DILEM12-G
<b>Main contacts</b>								
Rated impulse withstand voltage	$U_{imp}$	V AC		6000	6000	6000	6000	6000
Overvoltage category/pollution degree				III/3	III/3	III/3	III/3	III/3
Rated insulation voltage	$U_i$	V AC		690	690	690	690	690
Rated operating voltage	$U_e$	V AC		690	690	690	690	690
Safe isolation according to EN 61140								
	Between coil and contacts	V AC		300	300	300	300	300
	Between the contacts	V AC		300	300	300	300	300
Making capacity of up to 440 V (cos $\phi$ as specified in IEC/EN 60947)								
Breaking capacity	220/230 V	A		90	90	90	90	96
	380/400 V	A		90	90	90	90	96
	500 V	A		64	64	64	64	72
	660/690 V	A		42	42	42	42	42
Devices lifespan	AC-1			→ Engineering Page 5/92				
	AC-3			→ Engineering Page 5/91				
	AC-4			→ Engineering Page 5/91				
Short-circuit protection rating maximum fuse								
	Type "2" coordination 500 V	gL/gG	A	10	10	10	10	20
	Type "1" coordination 500 V	gL/gG	A	20	20	20	20	35
<b>AC voltage</b>								
AC-1 operation								
Conventional thermal current 3 pole 50 - 60 Hz								
Open	at 40 °C	$I_{th}$	A	22	22	22	22	22
				20	20	20	20	20
				19	19	19	19	19
Enclosed <sup>1)</sup>	at 50 °C	$I_{th}$	A	19	19	19	19	19
				16	16	16	16	16
				16	16	16	16	16
Enclosed <sup>1)</sup>	at 55 °C	$I_{th}$	A	16	16	16	16	16
				16	16	16	16	16
				16	16	16	16	16
Conventional thermal current, 1-pole								
Open <sup>1)</sup>		$I_{th}$	A	50	50	60	60	50
				40	40	50	50	40
Enclosed <sup>1)</sup>		$I_{th}$	A	40	40	50	50	40
				40	40	50	50	40
AC-3 operation								
Rated operational current AC-3 open, 50 - 60 Hz, 3-pole1)	220/230 V	$I_e$	A	6.6	9	9	9	12
	240 V	$I_e$	A	6.6	9	9	9	12
	380/400 V	$I_e$	A	6.6	9	9	9	12
	415 V	$I_e$	A	6.6	9	9	9	12
	440 V	$I_e$	A	6.6	9	9	9	10.5
	500 V	$I_e$	A	5	6.4	6.4	6.4	9
Motor rating	660/690 V	$I_e$	A	3.5	4.8	4.8	4.8	5.2
	220/230 V	P	kW	1.5	2.2	2.2	2.2	3.5
	240 V	P	kW	1.8	2.5	2.5	2.5	3
	380/400 V	P	kW	3	4	4	4	5.5
	415 V	P	kW	3.1	4.3	4.3	4.3	5.5
	440 V	P	kW	3.3	4.6	4.6	4.6	5.5
AC-4 operation	500 V	P	kW	3	4	4	4	5.5
	660/690 V	P	kW	3	4	4	4	4
	220/230 V	$I_e$	A	5	6.6	6.6	6.6	6.6
	240 V	$I_e$	A	5	6.6	6.6	6.6	6.6
	380/400 V	$I_e$	A	5	6.6	6.6	6.6	6.6
	415 V	$I_e$	A	5	6.6	6.6	6.6	6.6
Rated operational power	440 V	$I_e$	A	5	6.6	6.6	6.6	6.6
	500 V	$I_e$	A	3.7	5	5	5	5
	660/690 V	$I_e$	A	2.9	3.4	3.4	3.4	3.4
	220/230 V	P	kW	1.1	1.5	1.5	1.5	1.5
	240 V	P	kW	1.3	1.8	1.8	1.8	1.8
	380/400 V	P	kW	2.2	3	3	3	3
AC-4 operation	415 V	P	kW	2.3	3.1	3.1	3.1	3.1
	440 V	P	kW	2.4	3.3	3.3	3.3	3.3
	500 V	P	kW	2.2	3	3	3	2.2
	660/690 V	P	kW	2.2	3	3	3	2.2

**Notes**

<sup>1)</sup> At maximum permissible ambient air temperature

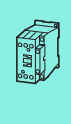

DILEEM, DILEM

				DILEEM	DILEEM-G	DILEM	DILEM-G	DILEM4	DILEM4-G	DILEM12	DILEM12-G
<b>DC voltage</b>											
Operations				→ Engineering Page 5/96							
Rated operational current open											
DC-1	12 V	$I_e$	A	20	20	20	20	20	20	20	20
	24 V	$I_e$	A	20	20	20	20	20	20	20	20
	60 V	$I_e$	A	20	20	20	20	20	20	20	20
	110 V	$I_e$	A	20	20	20	20	20	20	20	20
	220 V	$I_e$	A	20	20	20	20	20	20	20	20
DC-3	12 V	$I_e$	A	6	6	8	8	8	8	8	8
	24 V	$I_e$	A	6	6	8	8	8	8	6	8
	60 V	$I_e$	A	3	3	4	4	4	4	4	4
	110 V	$I_e$	A	2	2	3	3	3	3	3	3
	220 V	$I_e$	A	–	–	–	–	1	1	–	–
DC-5	12 V	$I_e$	A	1.8	1.8	2.5	2.5	2.5	2.5	2.5	2.5
	24 V	$I_e$	A	1.8	1.8	2.5	2.5	2.5	2.5	2.5	2.5
	60 V	$I_e$	A	1.8	1.8	2.5	2.5	2.5	2.5	2.5	2.5
	110 V	$I_e$	A	1.8	1.8	1.5	1.5	2.5	2.5	1.5	1.5
	220 V	$I_e$	A	0.2	0.2	0.3	0.3	1	1	0.3	0.3
Current heat loss (3-pole or 4-pole)											
At $I_{th}$			W	2	3.5	2	3.5	2.7	4.7	2	3.5
At $I_e$ to AC-3/400 V			W	0.5	0.7	0.5	0.7	–	–	0.5	0.7
<b>Magnet systems</b>											
Voltage tolerance											
Single-voltage coil 50 Hz and dual-voltage coil 50 Hz, 60 Hz			Pick-up $x U_c$	0.8 - 1.1	–	0.8 - 1.1	–	0.8 - 1.1	–	0.8 - 1.1	–
Dual-frequency coil 50/60 Hz			Pick-up $x U_c$	0.8 - 1.1	–	0.85 - 1.1	–	0.85 - 1.1	–	0.8 - 1.1	–
DC operated			Pick-up $x U_c$	–	0.8 - 1.1	–	0.8 - 1.1	–	0.85 - 1.1	–	0.8 - 1.1
Power consumption											
AC operation	Single-voltage coil, 50 Hz, and dual-voltage coil, 50 Hz, 60 Hz	Pick-up	VA	25	–	25	–	25	–	25	–
		Pick-up	W	22	–	22	–	22	–	22	–
		Sealing	VA	4.6	–	4.6	–	4.6	–	4.6	–
		Sealing	W	1.3	–	1.3	–	1.3	–	1.3	–
	Dual-frequency coil 50/60 Hz at 50 Hz	Pick-up	VA	30	–	30	–	30	–	30	–
		Pick-up	W	26	–	26	–	26	–	26	–
		Sealing	VA	5.4	–	5.4	–	5.4	–	5.4	–
		Sealing	W	1.6	–	1.6	–	1.6	–	1.6	–
	Dual-frequency coil 50/60 Hz at 60 Hz	Pick-up	VA	29	–	29	–	29	–	29	–
		Pick-up	W	24	–	24	–	24	–	24	–
		Sealing	VA	3.9	–	3.9	–	3.9	–	3.9	–
		Sealing	W	1.1	–	1.1	–	1.1	–	1.1	–
	Single-voltage coil, 50 Hz, and dual-voltage coil, 50 Hz, 60 Hz	Pick-up	VA	25	–	25	–	25	–	25	–
		Dual-frequency coil 50/60 Hz at 50 Hz	Pick-up	VA	30	–	30	–	30	–	30
Dual-frequency coil 50/60 Hz at 60 Hz		Pick-up	VA	29	–	29	–	29	–	29	–
DC operation <sup>1)</sup>	Power consumption pick-up = sealing	VA/W	–	2.6	–	2.6	–	2.6	–	2.6	
Duty factor			% DF	100	100	100	100	100	100	100	100
Switching times at 100 % $U_c$											
N/O	Closing delay min.	ms	14	26	14	26	14	26	14	26	26
	Closing delay max.	ms	21	35	21	35	21	35	21	35	35
	Opening delay min.	ms	8	15	8	15	8	15	8	15	15
	Opening delay max.	ms	18	25	18	25	18	25	18	25	25
	Closing delay with top mounting auxiliary contact	ms	Max. 45	Max. 70	Max. 45	Max. 70	Max. 45	Max. 70	Max. 45	Max. 70	Max. 70
Reversing contactors	Changeover time at 110 % $U_c$										
	Changeover time min.	ms	16	40	16	40	16	40	16	40	40
	Changeover time max.	ms	21	50	21	50	21	50	21	50	50
Arcing time at 690 V AC			ms	Max. 12	Max. 12	Max. 12	Max. 12	Max. 12	Max. 12	Max. 12	Max. 12
Coil	Lifespan, mechanical; Coil 50/60 Hz	c (contacts) $x 10^6$	7	–	7	–	7	–	7	–	–

Notes

<sup>1)</sup> Smoothed DC or three-phase bridge rectifier

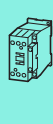



## DILEEM, DILEM

				DILE(E)M(-12)...	...DILEM
<b>Auxiliary contact</b>					
Interlocked opposing contacts to EN 60947-5-1 Annex L, including auxiliary contact module				Yes	Yes
Rated impulse withstand voltage	$U_{imp}$	V AC	6000	6000	
Overvoltage category/pollution degree			III/3	III/3	
Rated insulation voltage	$U_i$	V AC	690	690	
Rated operating voltage	$U_e$	V AC	600	600	
Safe isolation according to EN 61140					
Between coil and auxiliary contacts		V AC	300	300	
Between the auxiliary contacts		V AC	300	300	
Rated operational current					
AC-15					
	220/240 V	$I_e$	A	6	4
	380/415 V	$I_e$	A	3	2
	500 V	$I_e$	A	1.5	1.5
DC					
L/R ≤ 15 ms					
Contacts in series:					
	1	24 V	A	2.5	2.5
	2	60 V	A	2.5	2.5
	3	100 V	A	1.5	1.5
	3	220 V	A	0.5	0.5
Conventional thermal current				$I_{th}$	A
Control circuit reliability (at $U_e = 24$ V DC, $U_{min} = 17$ V, $I_{min} = 5.4$ mA)				Fault probability	$\lambda$
				<10 <sup>-8</sup> , < one failure in 100 million operations	
Component lifespan at $U_e = 240$ V					
AC-15		c (contacts)	x 10 <sup>6</sup>	0.2	0.2
DC <sup>1)</sup>					
L/R = 50 ms: 2 contacts in series at $I_e = 0.5$ A		c (contacts)	x 10 <sup>6</sup>	0.15	0.15
Short-circuit rating without welding					
Maximum overcurrent protective device				PKZM0-4	PKZM0-4
Short-circuit protection rating maximum fuse					
500 V			A gG/gL	6	6
500 V			A fast	10	10
Current heat loss at load of $I_{th}$					
Per contact			W	0.2	0.2

## Notes

<sup>1)</sup> Switch-on and switch-off conditions based on DC-13, time constant as specified

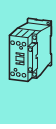

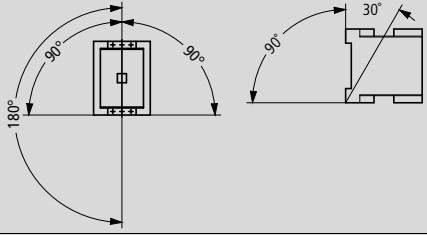
			DILM7	DILM9	DILM12	DILM15	DILM17	DILM25
<b>General</b>								
Standards			IEC/EN 60947, VDE 0660, UL, CSA					
Lifespan, mechanical								
AC operated	c (contacts)	x 10 <sup>6</sup>	10	10	10	10	10	10
DC operated	c (contacts)	x 10 <sup>6</sup>	10	10	10	10	10	10
Operating frequency, mechanical								
Mechanical, AC operated	Operations/h		9000	9000	9000	5000	5000	5000
DC operated	Operations/h		9000	9000	9000	5000	5000	5000
Maximum operating frequency								
Electrical (Contactor without overload relay)			→ Characteristic curves Page 5/78					
Climatic proofing			Damp heat, constant, to IEC 60068-2-78 Damp heat, cyclic, to IEC 60068-2-30					
Ambient temperature								
Open	°C		-25...60	-25...60	-25...60	-25...60	-25...60	-25...60
Enclosed	°C		-25...40	-25...40	-25...40	-25...40	-25...40	-25...40
Storage	°C		-40 - 80	-40 - 80	-40 - 80	-40 - 80	-40 - 80	-40 - 80
Mounting position AC- and DC operated								
Mechanical shock resistance (IEC/EN 60068-2-27)								
Half-sinusoidal shock 10 ms								
Main contacts		g	10	10	10	10	10	10
Auxiliary contacts		g	7	7	7	7	7	7
N/O		g	5	5	5	5	5	5
NC		g	5	5	5	5	5	5
Mechanical shock resistance (IEC/EN 60068-2-27) with table mounting								
Half-sinusoidal shock 10 ms								
Main contacts		g	5.7	5.7	5.7	5.7	6.9	6.9
Auxiliary contacts		g	3.4	3.4	3.4	3.4	5.3	5.3
N/O		g	3.4	3.4	3.4	3.4	3.5	3.5
NC		g	3.4	3.4	3.4	3.4	3.5	3.5
Protection type			IP20 IP20 IP20 IP20 IP00 IP00					
Protection against direct contact when actuated from front (EN 50274)			Finger- and back-of-hand proof					
Weight								
AC operated		kg	0.23	0.23	0.23	0.23	0.42	0.42
DC operated		kg	0.28	0.28	0.28	0.28	0.48	0.48
Terminal type, screw connection								
Terminal capacity of main cable								
Solid		mm <sup>2</sup>	1 x (0.75 - 4) 2 x (0.75 - 2.5)			1 x (0.75 - 16) 2 x (0.75 - 10)		
Flexible with ferrule		mm <sup>2</sup>	1 x (0.75 - 2.5) 2 x (0.75 - 2.5) <sup>1)</sup>			1 x (0.75 - 16) 2 x (0.75 - 10)		
Stranded		mm <sup>2</sup>	-			1 x 16 1 x 16		
Solid or stranded		AWG	18 - 10 18 - 10 18 - 10 18 - 10			18 - 6 18 - 6		
Flat conductor	Number of layers x width x thickness	mm	-			-		
Terminal capacity of control circuit cable								
Solid		mm <sup>2</sup>	1 x (0.75 - 4) 2 x (0.75 - 2.5)			1 x (0.75 - 4) 2 x (0.75 - 4)		
Flexible with ferrule		mm <sup>2</sup>	1 x (0.75 - 2.5) 2 x (0.75 - 2.5)			1 x (0.75 - 2.5) 2 x (0.75 - 2.5)		
Solid or stranded		AWG	18 - 10 18 - 10 18 - 10			18 - 10 18 - 14 18 - 14		

Notes

<sup>1)</sup> Also without ferrule.

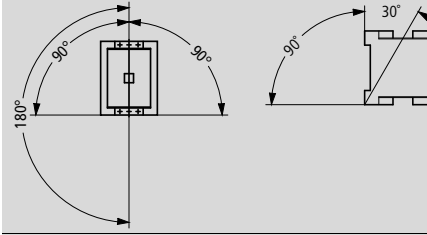
DILM32	DILM38	DILM40	DILM50	DILM65	DILM72	DILM80	DILM95	DILM115	DILM150	DILM170
IEC/EN 60947, VDE 0660, UL, CSA										
10	10	10	10	10	10	10	10	10	10	10
10	10	10	10	10	10	10	10	10	10	10
5000	5000	5000	5000	5000	5000	3600	3600	3600	3600	3000
5000	5000	5000	5000	5000	5000	3600	3600	3600	3600	3000
→ Characteristic curves Page 5/78										
Damp heat, constant, to IEC 60068-2-78 Damp heat, cyclic, to IEC 60068-2-30										
-25...60	-25...60	-25...60	-25...60	-25...60	-25...60	-25...60	-25...60	-25...60	-25...60	-25...60
-25...40	-25...40	-25...40	-25...40	-25...40	-25...40	-25...40	-25...40	-25...40	-25...40	-25...40
-40 - 80	-40 - 80	-40 - 80	-40 - 80	-40 - 80	-40 - 80	-40 - 80	-40 - 80	-40 - 80	-40 - 80	-40 - 80
										
Mechanical shock resistance (IEC/EN 60068-2-27)										
Half-sinusoidal shock 10 ms										
Main contacts		g	10	10	10	10	10	10	10	10
Auxiliary contacts		g	7	7	7	7	7	7	7	7
N/O		g	5	5	5	5	5	5	5	5
NC		g	5	5	5	5	5	5	5	5
Mechanical shock resistance (IEC/EN 60068-2-27) with table mounting										
Half-sinusoidal shock 10 ms										
Main contacts		g	6.9	6.9	10	10	10	10	10	10
Auxiliary contacts		g	5.3	5.3	7	7	7	7	7	7
N/O		g	3.5	3.5	5	5	5	5	5	5
NC		g	3.5	3.5	5	5	5	5	5	5
Protection type										
IP00 IP00 IP00 IP00 IP00 IP00 IP00 IP00 IP00 IP00 IP00										
Protection against direct contact when actuated from front (EN 50274)										
Finger- and back-of-hand proof										
Weight										
AC operated		kg	0.42	0.42	0.9	0.9	0.9	2	2	2
DC operated		kg	0.48	0.48	1.1	1.1	1.1	2.1	2.1	2.1
Terminal type, screw connection										
Terminal capacity of main cable										
Solid		mm <sup>2</sup>	1 x (0.75 - 16) 2 x (0.75 - 10)		1 x (0.75 - 16) 2 x (0.75 - 16)		-		-	
Flexible with ferrule		mm <sup>2</sup>	1 x (0.75 - 16) 2 x (0.75 - 10)		1 x (0.75 - 35) 2 x (0.75 - 25)		1 x (10 - 95) 2 x (10 - 70)		-	
Stranded		mm <sup>2</sup>	1 x 16 1 x 16		1 x (16 - 50) 2 x (16 - 35)		1 x (16 - 95) 2 x (16 - 70)		-	
Solid or stranded		AWG	18 - 6 18 - 6		12 - 2 12 - 2 12 - 2 12 - 2		8...3/0 8...3/0 8...3/0 8...3/0		8...3/0 8...3/0	
Flat conductor	Number of layers x width x thickness	mm	-		2 x (6 x 9 x 0.8)		2 x (6 x 16 x 0.8)		-	
Terminal capacity of control circuit cable										
Solid		mm <sup>2</sup>	1 x (0.75 - 4) 2 x (0.75 - 4)		1 x (0.75 - 4) 2 x (0.75 - 4)		1 x (0.75 - 4) 2 x (0.75 - 4)		1 x (0.75 - 4) 2 x (0.75 - 4)	
Flexible with ferrule		mm <sup>2</sup>	1 x (0.75 - 2.5) 2 x (0.75 - 2.5)		1 x (0.75 - 2.5) 2 x (0.75 - 2.5)		1 x (0.75 - 2.5) 2 x (0.75 - 2.5)		1 x (0.75 - 2.5) 2 x (0.75 - 2.5)	
Solid or stranded		AWG	18 - 14 18 - 14		18 - 14 18 - 14		18 - 14 18 - 14		18 - 14 18 - 14	

			DILM7	DILM9	DILM12	DILM15	DILM17	DILM25	
<b>General</b>									
Main cable connection screw/bolt			M3.5	M3.5	M3.5	M3.5	M5	M5	
Tightening torque		Nm	1.2	1.2	1.2	1.2	3.2	3.2	
Control circuit cable connection screw/bolt			M3.5	M3.5	M3.5	M3.5	M3.5	M3.5	
Tightening torque		Nm	1.2	1.2	1.2	1.2	1.2	1.2	
<b>Tools</b>									
<b>Main conductors</b>									
Pozidriv screwdriver		Size	2	2	2	2	2	2	
Internal hexagon	SW	mm	–	–	–	–	–	–	
Flat-blade screwdriver		mm	0.8 x 5.5 1 x 6	0.8 x 5.5 1 x 6	0.8 x 5.5 1 x 6	0.8 x 5.5 1 x 6	0.8 x 5.5 1 x 6	0.8 x 5.5 1 x 6	
<b>Auxiliary conductors</b>									
Pozidriv screwdriver		Size	2	2	2	2	2	2	
Flat-blade screwdriver		mm	0.8 x 5.5 1 x 6	0.8 x 5.5 1 x 6	0.8 x 5.5 1 x 6	0.8 x 5.5 1 x 6	0.8 x 5.5 1 x 6	0.8 x 5.5 1 x 6	
<b>Terminal type spring-cage terminal</b>									
<b>Terminal capacity of main cable</b>									
Solid		mm <sup>2</sup>	1 x (0.75 - 2.5) 2 x (0.75 - 2.5)				–	–	–
Flexible		mm <sup>2</sup>	1 x (0.75 - 2.5) 2 x (0.75 - 2.5)				–	–	–
Flexible with ferrule		mm <sup>2</sup>	1 x (0.75 - 1.5) 2 x (0.75 - 1.5)				–	–	–
Flexible without ferrule		mm <sup>2</sup>	1 x (0.75 - 2.5) 2 x (0.75 - 2.5)				–	–	–
Solid or stranded		AWG	18 - 14	18 - 14	18 - 14	18 - 14	–	–	
<b>Terminal capacity of control circuit cable</b>									
Solid		mm <sup>2</sup>	1 x (0.75 - 2.5) 2 x (0.75 - 2.5)				–	–	–
Flexible		mm <sup>2</sup>	1 x (0.75 - 2.5) 2 x (0.75 - 2.5)				–	–	–
Flexible with ferrule		mm <sup>2</sup>	1 x (0.75 - 1.5) 2 x (0.75 - 1.5)				–	–	–
Flexible without ferrule		mm <sup>2</sup>	1 x (0.75 - 2.5) 2 x (0.75 - 2.5)				–	–	–
Solid or stranded		AWG	18 - 14	18 - 14	18 - 14	18 - 14	18 - 14	18 - 14	
<b>Tools</b>									
Strip length		mm	10	10	10	10	10	10	
Screwdriver blade width		mm	3.5	3.5	3.5	3.5	3.5	3.5	
<b>Main contacts</b>									
Rated impulse withstand voltage	$U_{imp}$	V AC	8000	8000	8000	8000	8000	8000	
Overvoltage category/pollution degree			III/3	III/3	III/3	III/3	III/3	III/3	
Rated insulation voltage	$U_i$	V AC	690	690	690	690	690	690	
Rated operating voltage	$U_e$	V AC	690	690	690	690	690	690	
<b>Safe isolation according to EN 61140</b>									
Between coil and contacts		V AC	400	400	400	400	440	440	
Between the contacts		V AC	400	400	400	400	440	440	
Making capacity (cos φ to IEC/EN 60947)	To 690 V	A	112	112	144	155	238	350	
<b>Breaking capacity</b>									
230 V		A	70	90	120	124	170	250	
380/400 V		A	70	90	120	124	170	250	
500 V		A	50	70	100	100	170	250	
660/690 V		A	40	50	70	70	120	150	
<b>Short-circuit rating</b>									
<b>Short-circuit protection rating maximum fuse</b>									
<b>Type "2" coordination</b>									
400 V		gG/gL 500 V	A	20	20	20	20	35	35
690 V		gG/gL 690 V	A	16	16	20	20	35	35
<b>Type "1" coordination</b>									
400 V		gG/gL 500 V	A	35	35	35	63	63	100
690 V		gG/gL 690 V	A	20	20	25	50	50	50

DILM32	DILM38	DILM40	DILM50	DILM65	DILM72	DILM80	DILM95	DILM115	DILM150	DILM170
M5	M5	M6	M6	M6	M6	M10	M10	M10	M10	M10
3.2	3.2	3.3	3.3	3.3	3.3	14	14	14	14	14
M3.5	M3.5	M3.5	M3.5	M3.5	M3.5	M3.5	M3.5	M3.5	M3.5	M3.5
1.2	1.2	1.2	1.2	1.2	1.2	1.2	1.2	1.2	1.2	1.2
2	2	2	2	2	2	–	–	–	–	–
–	–	–	–	–	–	5	5	5	5	5
0.8 x 5.5 1 x 6	0.8 x 5.5 1 x 6	0.8 x 5.5 1 x 6	0.8 x 5.5 1 x 6	0.8 x 5.5 1 x 6	0.8 x 5.5 1 x 6	–	–	–	–	–
2	2	2	2	2	2	2	2	2	2	2
0.8 x 5.5 1 x 6	0.8 x 5.5 1 x 6	0.8 x 5.5 1 x 6	0.8 x 5.5 1 x 6	0.8 x 5.5 1 x 6	0.8 x 5.5 1 x 6	0.8 x 5.5 1 x 6	0.8 x 5.5 1 x 6	0.8 x 5.5 1 x 6	0.8 x 5.5 1 x 6	0.8 x 5.5 1 x 6
–	–	–	–	–	–	–	–	–	–	–
–	–	–	–	–	–	–	–	–	–	–
–	–	–	–	–	–	–	–	–	–	–
–	–	–	–	–	–	–	–	–	–	–
1 x (0.75 - 2.5) 2 x (0.75 - 2.5)	1 x (0.75 - 2.5) 2 x (0.75 - 2.5)	1 x (0.75 - 2.5) 2 x (0.75 - 2.5)	1 x (0.75 - 2.5) 2 x (0.75 - 2.5)	1 x (0.75 - 2.5) 2 x (0.75 - 2.5)	1 x (0.75 - 2.5) 2 x (0.75 - 2.5)	–	–	–	–	–
18 - 14	18 - 14	18 - 14	18 - 14	18 - 14	18 - 14	18 - 14	18 - 14	18 - 14	18 - 14	18 - 14
10	10	10	10	10	10	10	10	10	10	10
3.5	3.5	3.5	3.5	3.5	3.5	3.5	3.5	3.5	3.5	3.5
8000	8000	8000	8000	8000	8000	8000	8000	8000	8000	8000
III/3	III/3	III/3	III/3	III/3	III/3	III/3	III/3	III/3	III/3	III/3
690	690	690	690	690	690	690	690	690	690	690
690	690	690	690	690	690	690	690	690	690	690
440	440	440	440	440	440	690	690	690	690	690
440	440	440	440	440	440	690	690	690	690	690
384	384	560	700	910	910	1120	1330	1610	2100	2100
320	320	400	500	650	650	800	950	1150	1500	1500
320	320	400	500	650	650	800	950	1150	1500	1500
320	320	400	500	650	650	800	950	1150	1500	1500
180	180	250	320	370	370	650	800	1100	1200	1320
63	63	63	80	125	125	160	160	250	250	250
35	35	50	63	80	80	160	160	250	250	250
125	125	125	160	250	250	250	250	250	250	250
63	63	80	80	100	100	200	200	250	250	250

				DILM7	DILM9	DILM12	DILM15	DILM17	DILM25
<b>AC voltage</b>									
<b>AC-1 operation</b>									
Conventional free air thermal current 3 pole 50 - 60 Hz	Open	at 40 °C	I <sub>th</sub>	22	22	22	22	40	45
		at 50 °C	I <sub>th</sub>	21	21	21	21	38	43
		at 55 °C	I <sub>th</sub>	21	21	21	21	37	42
		at 60 °C	I <sub>th</sub>	20	20	20	20	35	40
	Enclosed	I <sub>th</sub>	18	18	18	18	32	36	
Conventional free air thermal current 1 pole	Open		I <sub>th</sub>	50	50	50	50	88	100
	Enclosed		I <sub>th</sub>	45	45	45	45	80	90
<b>AC-3 operation</b>									
Rated operational current AC -3 open, 50 - 60 Hz, 3 pole	220/230 V		I <sub>e</sub>	7	9	12	15.5	18	25
	240 V		I <sub>e</sub>	7	9	12	15.5	18	25
	380/400 V		I <sub>e</sub>	7	9	12	15.5	18	25
	415 V		I <sub>e</sub>	7	9	12	15.5	18	25
	440 V		I <sub>e</sub>	7	9	12	15.5	18	25
	500 V		I <sub>e</sub>	5	7	10	12.5	18	25
Rated operational power	220/230 V		P	2.2	2.5	3.5	4	5	7.5
	240 V		P	2.2	3	4	4.6	5.5	8.5
	380/400 V		P	3	4	5.5	7.5	7.5	11
	415 V		P	4	5.5	7	8	10	14.5
	440 V		P	4.5	5.5	7.5	8.4	10.5	15.5
	500 V		P	3.5	4.5	7	7.5	12	17.5
660/690 V			P	3.5	4.5	6.5	7	11	14
<b>AC-4 operation</b>									
Rated operational current AC-4 open, 50 - 60 Hz, 3 pole	220/230 V		I <sub>e</sub>	5	6	7	7	10	13
	240 V		I <sub>e</sub>	5	6	7	7	10	13
	380/400 V		I <sub>e</sub>	5	6	7	7	10	13
	415 V		I <sub>e</sub>	5	6	7	7	10	13
	440 V		I <sub>e</sub>	5	6	7	7	10	13
	500 V		I <sub>e</sub>	4.5	5	6	6	10	13
Rated operational power	220/230 V		P	1	1.5	2	2	2.5	3.5
	240 V		P	1.5	1.6	2.2	2.2	3	4
	380/400 V		P	2.2	2.5	3	3	4.5	6
	415 V		P	2.3	2.8	3.4	3.4	5	6.5
	440 V		P	2.4	3	3.6	3.6	5.5	7
	500 V		P	2.5	2.8	3.5	3.5	6	8
660/690 V			P	2.9	3.6	4.4	4.4	6.5	8.5
<b>DC voltage</b>									
Operations				→ Switching of DC current Page 5/96					
<b>Rated operational current I<sub>e</sub> open</b>									
DC-1 operation	60 V		I <sub>e</sub>	20	20	20	20	35	40
	110 V		I <sub>e</sub>	20	20	20	20	35	40
	220 V		I <sub>e</sub>	15	15	15	15	35	40
	440 V		I <sub>e</sub>	1	1.3	1.3	1.3	2.9	2.9
DC-3 operation	60 V		I <sub>e</sub>	20	20	20	20	35	35
	110 V		I <sub>e</sub>	20	20	20	20	35	35
	220 V		I <sub>e</sub>	1.5	1.5	1.5	1.5	10	10
	440 V		I <sub>e</sub>	0.2	0.2	0.2	0.2	0.6	0.6
DC-5 operation	60 V		I <sub>e</sub>	20	20	20	20	35	35
	110 V		I <sub>e</sub>	20	20	20	20	35	35
	220 V		I <sub>e</sub>	1.5	1.5	1.5	1.5	10	10
	440 V		I <sub>e</sub>	0.2	0.2	0.2	0.2	0.6	0.6

DILM32	DILM38	DILM40	DILM50	DILM65	DILM72	DILM80	DILM95	DILM115	DILM150	DILM170
45	45	60	80	98	98	110	130	160	190	225
43	43	57	71	88	88	98	125	142	180	200
42	42	55	68	83	83	94	115	135	170	190
40	40	50	65	80	80	90	110	130	160	185
36	36	45	58	72	72	80	100	115	144	166
100	100	125	162	200	200	225	275	325	400	460
90	90	112	145	180	180	200	250	285	360	415
32	38	40	50	65	72	80	95	115	150	170
32	38	40	50	65	72	80	95	115	150	170
32	38	40	50	65	72	80	95	115	150	170
32	38	40	50	65	72	80	95	115	150	170
32	38	40	50	65	72	80	95	115	150	170
18	22.5	25	32	37	37	65	80	93	100	150
10	11	12.5	15.5	20	22	25	30	37	48	52
11	12	13.5	17	22	25	27.5	32	40	52	57
15	18.5	18.5	22	30	37	37	45	55	75	90
19	20	24	30	39	41	48	57	70	91	100
20	21	25	32	41	44	51	60	75	95	105
23	24	28	36	47	50	58	70	85	110	120
17	21	23	30	35	35	63	75	90	96	140
15	15	18	21	25	25	40	50	55	65	65
15	15	18	21	25	25	40	50	55	65	65
15	15	18	21	25	25	40	50	55	65	65
15	15	18	21	25	25	40	50	55	65	65
15	15	18	21	25	25	40	50	55	65	65
12	12	14	17	20	20	27	37	45	50	50
4	4	5	6	7	7	12	16	17	20	20
4.5	4.5	5.5	6.5	7.5	7.5	13	17	19	22	22
7	7	9	10	12	12	20	26	28	33	33
7.5	7.5	9.5	11	13	13	24	30	33	39	39
8	8	10	12	14	14	25	32	35	41	41
9	9	11	13	16	16	29	36	40	47	47
10	10	12	14	17	17	26	35	43	48	48
40	40	50	60	72	72	110	110	160	160	160
40	40	50	50	72	72	110	110	160	160	160
40	40	45	45	65	65	70	70	90	90	90
2.9	2.9	2.9	2.9	2.9	2.9	4.5	4.5	4.5	4.5	4.5
40	40	50	60	72	72	110	110	160	160	160
40	40	50	50	72	72	110	110	160	160	160
25	25	25	25	35	35	35	35	40	40	40
0.6	0.6	0.6	0.6	0.6	0.6	1	1	1	1	1
40	40	50	60	72	72	110	110	160	160	160
40	40	50	50	72	72	110	110	160	160	160
10	10	25	25	35	35	35	35	40	40	40
0.6	0.6	0.6	0.6	0.6	0.6	1	1	1	1	1

			DILM7	DILM9	DILM12	DILM15	DILM17	DILM25
<b>Current heat loss (3 pole)</b>								
Current heat loss at I <sub>th</sub>	W		3	3	3	3	7.3	9.6
Current heat loss at I <sub>th</sub> to AC-3/400 V	W		0.37	0.6	1.1	1.8	1.9	3.8
Impedance per pole	mΩ		2.5	2.5	2.5	2.5	2	2
<b>Magnet systems</b>								
Voltage tolerance								
AC operated	Pick-up	x U <sub>c</sub>	0.8 - 1.1	0.8 - 1.1	0.8 - 1.1	0.8 - 1.1	0.8 - 1.1	0.8 - 1.1
AC operated	Drop-out	x U <sub>c</sub>	0.3 - 0.6	0.3 - 0.6	0.3 - 0.6	0.3 - 0.6	0.3 - 0.6	0.3 - 0.6
DC operated <sup>3)</sup>	Pick-up	x U <sub>c</sub>	0.8 - 1.1	0.8 - 1.1 <sup>1)</sup>	0.8 - 1.1 <sup>1)</sup>	0.8 - 1.1 <sup>1)</sup>	0.7 - 1.2 <sup>2)</sup>	0.7 - 1.2 <sup>2)</sup>
DC operated <sup>3)</sup>	Drop-out	x U <sub>c</sub>	0.15 - 0.6	0.15 - 0.6	0.15 - 0.6	0.15 - 0.6	0.15 - 0.6	0.15 - 0.6
Power consumption of the coil in a cold state and 1.0 x U <sub>c</sub>								
50 Hz	Pick-up	VA	24	24	24	24	52	52
50 Hz	Sealing	VA	3.4	3.4	3.4	3.4	7.1	7.1
50 Hz	Sealing	W	1.2	1.2	1.2	1.2	2.1	2.1
60 Hz	Pick-up	VA	30	30	30	30	67	67
60 Hz	Sealing	VA	4.4	4.4	4.4	4.4	8.7	8.7
60 Hz	Sealing	W	1.4	1.4	1.4	1.4	2.6	2.6
50/60 Hz	Pick-up	VA	27	27	27	27	62	62
			25	25	25	25	58	58
50/60 Hz	Sealing	VA	4.2	4.2	4.2	4.2	9.1	9.1
			3.3	3.3	3.3	3.3	6.5	6.5
50/60 Hz	Sealing	W	1.4	1.4	1.4	1.4	2.5	2.5
			1.2	1.2	1.2	1.2	2	2
DC operated	Pick-up	W	3	3	4.5	4.5	12	12
DC operated	Sealing	W	3	3	4.5	4.5	0.5	0.5
Duty factor	% DF		100	100	100	100	100	100
Changeover times at 100 % U <sub>c</sub> (recommended values)								
Main contacts								
AC operated	Closing delay	ms	15...21	15...21	15...21	15...21	16...22	16...22
	Opening delay	ms	9...18	9...18	9...18	9...18	8...14	8...14
DC operated	Closing delay	ms	31	31	31	31	47	47
	Opening delay	ms	12	12	12	12	30	30
Arcing time		ms	10	10	10	10	10	10
Permissible residual current when A1 - A2 are actuated from the electronic system (with 0 signal)		mA	-	-	-	-	-	-
Lifespan, mechanical; Coil 50/60 Hz	At 50 Hz		Mechanical lifespan at 50 Hz approx. 30% lower than under → Technical data general					
<b>Electromagnetic compatibility (EMC)</b>								
Emitted interference			To EN 60947-1					
Interference immunity			To EN 60947-1					

- Notes**
- <sup>1)</sup> At 24 V DC: 0.7 – 1.3 without auxiliary contact module and at ambient temperature + 40 °C
  - <sup>2)</sup> RDC 24 (U<sub>min</sub> 24 V DC/U<sub>max</sub> 27 V DC)  
RDC 60 (U<sub>min</sub> 48 V DC/U<sub>max</sub> 60 V DC)  
RDC 130 (U<sub>min</sub> 110 V DC/U<sub>max</sub> 130 V DC)  
RDC 240 (U<sub>min</sub> 200 V DC/U<sub>max</sub> 240 V DC)  
Example: U<sub>c</sub> = 0.7 x U<sub>min</sub> - 1.2 x U<sub>max</sub> / U<sub>c</sub> = 0.7 x 24 V - 1.2 x 27 V DC
  - <sup>3)</sup> At least: smoothed two-phase bridge rectifier or three-phase rectifier

DILM32	DILM38	DILM40	DILM50	DILM65	DILM72	DILM80	DILM95	DILM115	DILM150	DILM170
12.1	12.1	11.3	19	28.8	28.8	12.2	18.2	20.3	30.7	41.1
6.1	6.1	7.2	11.3	19	23	9.6	13.5	15.9	27	34.7
2	2	1.5	1.5	1.5	1.5	0.5	0.5	0.4	0.4	0.4
0.8 - 1.1	0.8 - 1.1	0.8 - 1.1	0.8 - 1.1	0.8 - 1.1	0.8 - 1.1	0.8 - 1.1	0.8 - 1.1	0.8 - 1.15	0.8 - 1.15	0.8 - 1.15
0.3 - 0.6	0.3 - 0.6	0.3 - 0.6	0.3 - 0.6	0.3 - 0.6	0.3 - 0.6	0.3 - 0.6	0.3 - 0.6	0.25 - 0.6	0.25 - 0.6	0.25 - 0.6
0.7 - 1.2 <sup>2)</sup>	0.7 - 1.2 <sup>2)</sup>	0.7 - 1.2 <sup>2)</sup>	0.7 - 1.2 <sup>2)</sup>	0.7 - 1.2 <sup>2)</sup>	0.7 - 1.2 <sup>2)</sup>	0.7 - 1.2 <sup>2)</sup>	0.7 - 1.2 <sup>2)</sup>	0.7 - 1.2 <sup>2)</sup>	0.7 - 1.2 <sup>2)</sup>	0.7 - 1.2 <sup>2)</sup>
0.15 - 0.6	0.15 - 0.6	0.15 - 0.6	0.15 - 0.6	0.15 - 0.6	0.15 - 0.6	0.15 - 0.6	0.15 - 0.6	0.15 - 0.6	0.15 - 0.6	0.15 - 0.6
52	52	149	149	149	149	310	310	180	180	180
7.1	7.1	16	16	16	16	26	26	3.1	3.1	3.1
2.1	2.1	4.3	4.3	4.3	4.3	5.8	5.8	2.1	2.1	2.1
67	67	178	178	178	178	345	345	170	170	170
8.7	8.7	19	19	19	19	30	30	3.1	3.1	3.1
2.6	2.6	5.3	5.3	5.3	5.3	7.1	7.1	2.1	2.1	2.1
62	62	168	168	168	168	372	372	170	170	170
58	58	154	154	154	154	328	328	170	170	170
9.1	9.1	22	22	22	22	37.1	37.1	3.1	3.1	3.1
6.5	6.5	14	14	14	14	22.6	22.6	3.1	3.1	3.1
2.5	2.5	5.3	5.3	5.3	5.3	7.5	7.5	2.1	2.1	2.1
2	2	4.3	4.3	4.3	4.3	6.1	6.1	2.1	2.1	2.1
12	12	24	24	24	24	90	90	149	149	149
0.5	0.5	0.5	0.5	0.5	0.5	1.3	1.3	2.1	2.1	2.1
100	100	100	100	100	100	100	100	100	100	100
16...22	16...22	12...18	12...18	12...18	12...18	14...20	14...20	28...33	28...33	28...33
8...14	8...14	8...13	8...13	8...13	8...13	9...14	9...14	35...41	35...41	35...41
47	47	54	54	54	54	45	45	35	35	35
30	30	24	24	24	24	34	34	30	30	30
10	10	10	10	10	10	15	15	15	15	15
-	-	-	-	-	-	≤ 1	≤ 1	≤ 1	≤ 1	≤ 1
Mechanical lifespan at 50 Hz approx. 30% lower than under → Technical data general										
To EN 60947-1										
To EN 60947-1										

		Contactors							
		DILM185A	DILM225A	DILM250	DILM300A	DILM400	DILM500	DILM570	
<b>General</b>									
Standards		IEC/EN 60947, VDE 0660, UL, CSA							
Lifespan, mechanical									
AC operated	c (contacts)	x 10 <sup>6</sup>	10	10	10	10	7	7	7
DC operated	c (contacts)	x 10 <sup>6</sup>	10	10	10	10	7	7	7
Operating frequency, mechanical									
AC operated	Operations/h		3000	3000	3000	3000	2000	2000	2000
DC operated	Operations/h		3000	3000	3000	3000	2000	2000	2000
Maximum operating frequency									
Electrical (Contactor without overload relay)		→ Engineering Page 5/95							
Climatic proofing									
		Damp heat, constant, to IEC 60068-2-78							
		Damp heat, cyclic, to IEC 60068-2-30							
Ambient temperature									
Open	°C	-25...60	-25...60	-25...60	-25...60	-25...60	-25...60	-25...60	-25...60
Enclosed	°C	-25...40	-25...40	-25...40	-25...40	-25...40	-25...40	-25...40	-25...40
Storage	°C	-40 - 80	-40 - 80	-40 - 80	-40 - 80	-40 - 80	-40 - 80	-40 - 80	-40 - 80
Mounting position: AC and DC-actuated									
Mechanical shock resistance (IEC/EN 60068-2-27)									
Half-sinusoidal shock 10 ms									
Main contacts									
N/O	g	10	10	10	10	10	10	10	10
Auxiliary contacts									
N/O	g	10	10	10	10	10	10	10	10
NC	g	8	8	8	8	8	8	8	8
Protection type		IP00							
Protection against direct contact when actuated from front (EN 90274)		Finger- and back-of-hand proof with cover or terminal block							
Weight									
Weight	kg	3.2	3.2	6.5	6.5	8	8	8	8
Terminal capacity of main cable									
Flexible with cable lug	mm <sup>2</sup>	50 - 185	50 - 185	50 - 240	50 - 240	50 - 240	50 - 240	50 - 240	50 - 240
Stranded with cable lug	mm <sup>2</sup>	50 - 185	70 - 185	70 - 240	70 - 240	70 - 240	70 - 240	70 - 240	70 - 240
Solid or stranded	AWG	1/0 - 350 MCM	2/0 - 250 MCM	2/0 - 500 MCM	2/0 - 500 MCM	2/0 - 500 MCM	2/0 - 500 MCM	2/0 - 500 MCM	2/0 - 500 MCM
Busbar	Width	mm	32	32	25	25	30	30	30
Main cable connection screw/bolt		M10							
Tightening torque		Nm							
Terminal capacity of control circuit cable									
Solid		mm <sup>2</sup>							
		1 x (0.75 - 2.5) 2 x (0.75 - 2.5)							
Flexible with ferrule		mm <sup>2</sup>							
		1 x (0.75 - 2.5) 2 x (0.75 - 2.5)							
Solid or stranded		AWG							
		2 x (18 - 12) 2 x (18 - 12) 2 x (18 - 12) 2 x (18 - 12) 2 x (18 - 12) 2 x (18 - 12) 2 x (18 - 12)							
Control circuit cable connection screw/bolt		M3.5							
Tightening torque		Nm							
		1.2							
Tools									
Main conductors									
Wrench		mm							
		16							
Auxiliary conductors									
Poqidriv screwdriver		Size							
		2							

		DILM580	DILM650	DILM750	DILM820	DILM1000	DILM1600	DILH1400	DILH2000	DILH2200	DILH2600	
<b>General</b>												
Standards		IEC/EN 60947, VDE 0660, UL, CSA										
Lifespan, mechanical												
AC operated	c (contacts)	5	5	5	5	5	5	5	5	5	5	
DC operated	c (contacts)	5	5	5	5	5	5	5	5	5	5	
Operating frequency, mechanical												
AC operated	Operations/h	1000	1000	1000	1000	1000	1000	1000	1000	1000	1000	
DC operated	Operations/h	1000	1000	1000	1000	1000	1000	1000	1000	1000	1000	
Maximum operating frequency												
Electrical (Contactor without overload relay)		→ Engineering Page 5/95										
Climatic proofing												
		Damp heat, constant, to IEC 60068-2-78										
		Damp heat, cyclic, to IEC 60068-2-30										
Ambient temperature												
Open	°C	-25...60	-25...60	-25...60	-25...60	-25...60	-25...60	-25...60	-25...60	-25...60	-25...60	
Enclosed	°C	-25...40	-25...40	-25...40	-25...40	-25...40	-25...40	-25...40	-25...40	-25...40	-25...40	
Storage	°C	-40 - 80	-40 - 80	-40 - 80	-40 - 80	-40 - 80	-40 - 80	-40 - 80	-40 - 80	-40 - 80	-40 - 80	
Mounting position: AC and DC-actuated												
Mechanical shock resistance (IEC/EN 60068-2-27)												
Half-sinusoidal shock 10 ms												
Main contacts												
N/O	g	10	10	10	10	10	10	10	10	10	10	
Auxiliary contacts												
N/O	g	10	10	10	10	10	10	10	10	10	10	
NC	g	8	8	8	8	8	8	8	8	8	8	
Protection type		IP00										
Protection against direct contact when actuated from front (EN 90274)		Finger- and back-of-hand proof with cover or terminal block										
Weight												
Weight	kg	15	15	15	15	15	32	15	32	32	32	
Terminal capacity of main cable												
Flexible with cable lug	mm <sup>2</sup>	50 - 240	50 - 240	50 - 240	50 - 240	50 - 240	-	-	-	-	-	
Stranded with cable lug	mm <sup>2</sup>	70 - 240	70 - 240	70 - 240	70 - 240	70 - 240	-	-	-	-	-	
Solid or stranded	AWG	2/0 - 500 MCM	2/0 - 500 MCM	2/0 - 500 MCM	2/0 - 500 MCM	2/0 - 500 MCM	-	-	-	-	-	
Busbar	Width	mm	50	60	60	60	100	80	100	100	100	
Main cable connection screw/bolt		M10										
Tightening torque		Nm										
		24										
Terminal capacity of control circuit cable												
Solid		mm <sup>2</sup>										
		1 x (0.75 - 2.5) 2 x (0.75 - 2.5)										
Flexible with ferrule		mm <sup>2</sup>										
		1 x (0.75 - 2.5) 2 x (0.75 - 2.5)										
Solid or stranded		AWG										
		2 x (18 - 12) 2 x (18 - 12) 2 x (18 - 12) 2 x (18 - 12) 2 x (18 - 12) 2 x (18 - 12) 2 x (18 - 12) 2 x (18...12) 2 x (18 - 12) 2 x (18 - 12) 2 x (18 - 12) 2 x (18 - 12)										
Control circuit cable connection screw/bolt		M3.5										
Tightening torque		Nm										
		1.2										
Tools												
Main conductors												
Wrench		mm										
		16										
Auxiliary conductors												
Poqidriv screwdriver		Size										
		2										

			Contactors						
			DILM185A	DILM225A	DILM250	DILM300A	DILM400	DILM500	DILM570
<b>Main contacts</b>									
Rated impulse withstand voltage	$U_{imp}$	V AC	8000	8000	8000	8000	8000	8000	8000
Overvoltage category/pollution degree			III/3	III/3	III/3	III/3	III/3	III/3	III/3
Rated insulation voltage	$U_i$	V AC	1000	1000	1000	1000	1000	1000	1000
Rated operating voltage	$U_e$	V AC	1000	1000	1000	1000	1000	1000	1000
Safe isolation according to EN 61140									
Between coil and contacts		V AC	500	500	500	500	500	500	500
Between the contacts		V AC	500	500	500	500	500	500	500
Making capacity (cos φ to IEC/EN 60947)		A	2700	2700	3000	3600	5500	5500	6000
Breaking capacity									
220/230 V		A	2250	2250	2500	3000	5000	5000	5800
380/400 V		A	2250	2250	2500	3000	5000	5000	5800
500 V		A	2250	2250	2500	3000	5000	5000	5800
660/690 V		A	2250	2250	2500	3000	5000	5000	5800
1000 V		A	760	760	760	950	950	950	950
Component lifespan			→ Page 5/91						
Short-circuit rating									
Short-circuit protection rating maximum fuse									
Type "2" coordination									
400 V	gG/gL 500 V	A	250	250	315	315	500	500	500
690 V	gG/gL 690 V	A	250	250	315	315	500	500	500
1000 V	gG/gL 1000 V	A	160	160	160	160	200	200	200
Type "1" coordination									
400 V	gG/gL 500 V	A	400	400	400	400	630	630	800
690 V	gG/gL 690 V	A	315	315	400	400	630	630	630
1000 V	gG/gL 1000 V	A	200	200	200	200	250	250	250
<b>AC voltage</b>									
<b>AC-1 operation</b>									
Conventional thermal current 3 pole 50 - 60 Hz									
Open									
at 40 °C	$I_{th}$	A	337	356	400	430	612	857	920
at 50 °C	$I_{th}$	A	301	310	360	385	548	767	821
at 55 °C	$I_{th}$	A	287	295	340	365	522	731	783
at 60 °C	$I_{th}$	A	275	285	330	350	500	700	750
Enclosed <sup>1)</sup>	$I_{th}$	A	245	275	300	315	450	650	-
Conventional thermal current, 1-pole									
Open <sup>1)</sup>	$I_{th}$	A	685	707	825	875	1250	1750	1875
Enclosed <sup>1)</sup>	$I_{th}$	A	625	636	742	785	1125	1600	-
<b>AC-3 operation</b>									
Rated operational current AC -3 open, 50 - 60 Hz, 3 pole									
220/230 V	$I_e$	A	185	225	250	300	400	500	580
240 V	$I_e$	A	185	225	250	300	400	500	580
380/400 V	$I_e$	A	185	225	250	300	400	500	580
415 V	$I_e$	A	185	225	250	300	400	500	580
440 V	$I_e$	A	185	225	250	300	400	500	580
500 V	$I_e$	A	185	225	250	300	400	500	500
660/690 V	$I_e$	A	150	160	250	210	360	360	360
1000 V	$I_e$	A	76	76	76	95	95	95	95
Rated operational power									
220/230 V	P	kW	55	70	75	90	125	155	185
240 V	P	kW	62	75	85	100	132	170	200
380/400 V	P	kW	90	110	132	160	200	250	315
415 V	P	kW	110	132	148	180	240	300	348
440 V	P	kW	115	138	132	185	200	250	370
500 V	P	kW	132	160	180	215	290	360	360
660/690 V	P	kW	140	150	240	195	344	344	344
1000 V	P	kW	108	108	108	132	132	132	132

Notes: <sup>1)</sup> At maximum permissible ambient air temperature  
<sup>2)</sup> To 690 V

DILM580	DILM650	DILM750	DILM820	DILM1000	DILM1600	DILH1400	DILH2000	DILH2200	DILH2600
8000	8000	8000	8000	8000	8000	8000	8000	8000	8000
III/3	III/3	III/3	III/3	III/3	III/3	III/3	III/3	III/3	III/3
1000	1000	1000	1000	1000	1000	1000	1000	1000	1000
1000	1000	1000	1000	1000	1000	1000	1000	1000	1000
500	500	500	500	500	500	500	500	500	500
500	500	500	500	500	500	500	500	500	500
7800	7800	9840	9840	9840	19000	9840	9840	9840	9840
6500	6500	8200	8200	8200	16000	8200	8200	8200	8200
6500	6500	8200	8200	8200	16000	8200	8200	8200	8200
6500	6500	8200	8200	8200	16000	8200	8200	8200	8200
6500	6500	8200	8200	8200	16000	8200	8200	8200	8200
4350	4350	5800	5800	5800	5800	5800	5800	5800	5800
→ Page 5/91									
630	630	630	630	630	-	-	-	-	-
630	630	630	630	630	-	-	-	-	-
500	500	630	630	630	-	-	-	-	-
1000	1000	1200	1200	1200	-	-	-	-	-
1000	1000	1200	1200	1200	-	-	-	-	-
630	630	800	800	800	-	-	-	-	-
980	1041	1102	1225	1225	2200 <sup>2)</sup>	1714 <sup>2)</sup>	2450 <sup>2)</sup>	2700 <sup>2)</sup>	3185 <sup>2)</sup>
876	931	986	1095	1095	1970 <sup>2)</sup>	1533 <sup>2)</sup>	2190 <sup>2)</sup>	2400 <sup>2)</sup>	2847 <sup>2)</sup>
836	888	940	1044	1044	1880 <sup>2)</sup>	1462 <sup>2)</sup>	2089 <sup>2)</sup>	2300 <sup>2)</sup>	2716 <sup>2)</sup>
800	850	900	1000	1000	1800 <sup>2)</sup>	1400 <sup>2)</sup>	2000 <sup>2)</sup>	2200 <sup>2)</sup>	2600 <sup>2)</sup>
-	-	-	-	-	-	-	-	-	-
2000	2125	2250	2500	2500	4500	3500	5000	5500	6500 <sup>2)</sup>
-	-	-	-	-	-	-	-	-	-
580	650	750	820	1000	1600	-	-	-	-
580	650	750	820	1000	1600	-	-	-	-
580	650	750	820	1000	1600	-	-	-	-
580	650	750	820	1000	1600	-	-	-	-
580	650	750	820	1000	1600	-	-	-	-
580	650	750	820	1000	1600	-	-	-	-
435	435	580	580	750	1200	-	-	-	-
185	205	240	260	315	500	-	-	-	-
200	225	260	285	340	550	-	-	-	-
315	355	400	450	560	900	-	-	-	-
348	390	455	500	610	930	-	-	-	-
370	420	480	450	650	1000	-	-	-	-
420	470	550	600	730	1180	-	-	-	-
560	630	720	750	1000	1600	-	-	-	-
600	600	800	800	1100	1770	-	-	-	-



			Contactors						
			DILM185A	DILM225A	DILM250	DILM300A	DILM400	DILM500	DILM570
<b>AC voltage</b>									
AC-4 operation									
Rated operational current AC -4 open, 50 – 60 Hz, 3 pole									
220/230 V	I <sub>e</sub>	A	136	164	200	240	296	360	360
240 V	I <sub>e</sub>	A	136	164	200	240	296	360	360
380/400 V	I <sub>e</sub>	A	136	164	200	240	296	360	360
415 V	I <sub>e</sub>	A	136	164	200	240	296	360	360
440 V	I <sub>e</sub>	A	136	164	200	240	296	360	360
500 V	I <sub>e</sub>	A	136	164	200	240	296	360	360
660/690 V	I <sub>e</sub>	A	110	120	200	170	296	296	296
1000 V	I <sub>e</sub>	A	55	55	76	76	95	95	95
Rated operational power									
220/230 V	P	kW	41	51	62	75	92	112	112
240 V	P	kW	45	54	68	82	101	122	122
380/400 V	P	kW	75	90	110	132	160	200	200
415 V	P	kW	80	96	117	142	176	216	216
440 V	P	kW	85	102	125	150	186	229	229
500 V	P	kW	96	116	143	172	214	260	260
660/690 V	P	kW	102	110	189	160	283	344	344
1000 V	P	kW	77	77	108	109	132	132	132
<b>Capacitor operation</b>									
Individual compensation rated operational current I <sub>e</sub> of alternating current capacitor									
Open									
To 525 V	A		220	220	220	307	307	307	307
690 V	A		133	133	133	177	177	177	177
Max. peak inrush current	x I <sub>e</sub>		30	30	30	30	30	30	30
Component lifespan	c (contacts)	x 10 <sup>6</sup>	0.1	0.1	0.1	0.1	0.1	0.1	0.1
Max. operating frequency		Ops/h	200	200	200	200	200	200	200
<b>DC voltage</b>									
Operations			→ Engineering Page 5/96						
Rated operational current I <sub>e</sub> open									
DC-1 operation									
60 V	I <sub>e</sub>	A	300	300	300	400	400	400	400
110 V	I <sub>e</sub>	A	300	300	300	400	400	400	400
220 V	I <sub>e</sub>	A	300	300	300	400	400	400	400
440 V	I <sub>e</sub>	A	11	11	11	11	11	11	11
DC-3 operation									
60 V	I <sub>e</sub>	A	300	300	300	400	400	400	400
110 V	I <sub>e</sub>	A	300	300	300	400	400	400	400
220 V	I <sub>e</sub>	A	300	300	300	400	400	400	400
DC-5 operation									
60 V	I <sub>e</sub>	A	300	300	300	400	400	400	400
110 V	I <sub>e</sub>	A	300	300	300	400	400	400	400
220 V	I <sub>e</sub>	A	300	300	300	400	400	400	400
<b>Current heat loss (3 pole)</b>									
Current heat loss at I <sub>th</sub>		W	34	45	55	37	58	113	130
Current heat loss at I <sub>e</sub> to AC-3/400 V		W	16	23	28	21	37	58	78

DILM580	DILM650	DILM750	DILM820	DILM1000	DILM1600	DILH1400	DILH2000	DILH2200	DILH2600
456	512	576	656	800	1280	–	–	–	–
456	512	576	656	800	1280	–	–	–	–
456	512	576	656	800	1280	–	–	–	–
456	512	576	656	800	1280	–	–	–	–
456	512	576	656	800	1280	–	–	–	–
456	512	576	656	800	1280	–	–	–	–
456	512	576	656	800	1280	–	–	–	–
348	348	464	464	700	1120	–	–	–	–
143	161	181	209	260	430	–	–	–	–
156	176	200	228	280	450	–	–	–	–
250	280	315	355	450	750	–	–	–	–
274	307	346	394	490	770	–	–	–	–
290	326	367	418	520	830	–	–	–	–
330	370	417	474	590	940	–	–	–	–
440	494	556	633	780	1300	–	–	–	–
509	509	678	678	1000	1650	–	–	–	–
463	463	463	463	463	–	–	–	–	–
265	265	265	265	265	–	–	–	–	–
30	30	30	30	30	–	–	–	–	–
0.1	0.1	0.1	0.1	0.1	–	–	–	–	–
200	200	200	200	200	–	–	–	–	–
–	–	–	–	–	–	–	–	–	–
–	–	–	–	–	–	–	–	–	–
–	–	–	–	–	–	–	–	–	–
–	–	–	–	–	–	–	–	–	–
–	–	–	–	–	–	–	–	–	–
–	–	–	–	–	–	–	–	–	–
61	69	78	96	96	155	188	192	232	250
32	41	54	65	96	123	–	–	–	–



			DILMP20	DILMP32 DILMP45	DILMP63 DILMP80	DILMP125 DILMP160 DILMP200
<b>General</b>						
Standards			IEC/EN 60947, VDE 0660, UL, CSA			
Lifespan, mechanical						
AC operated	c (contacts)	x 10 <sup>6</sup>	10			
DC operated	c (contacts)	x 10 <sup>6</sup>	10			
Operating frequency, mechanical						
Mechanical, AC operated	Operations/h		5000		3600	
DC operated	Operations/h		5000		3600	
Maximum operating frequency			600			
Electrical (Contactor without overload relay)			600			
Climatic proofing			Damp heat, constant, to IEC 60068-2-3 Damp heat, cyclic, to IEC 60068-2-30			
Ambient temperature						
Open		°C	-25...60			
Enclosed		°C	-25...40			
Storage		°C	-40 - 80			
Mounting position AC- and DC operated						
Mechanical shock resistance (IEC/EN 60068-2-27)						
Half-sinusoidal shock 10 ms						
Main contacts						
N/O		g	10			
Auxiliary contacts						
N/O		g	7			
NC		g	5			
Protection type			IP20	IP00		
With accessories			–	IP20		
Protection against direct contact when actuated from front (EN 50274)			Finger- and back-of-hand proof			
<b>Terminal type, screw connection</b>						
Terminal capacity of main cable						
Solid		mm <sup>2</sup>	1 x (0.75 - 4) 2 x (0.75 - 2.5)	1 x (0.75 - 16) 2 x (0.75 - 10)	1 x (2.5 - 16) 2 x (2.5 - 16)	–
Flexible with ferrule		mm <sup>2</sup>	1 x (0.75 - 2.5) 2 x (0.75 - 2.5)	1 x (0.75 - 16) 2 x (0.75 - 10)	1 x (2.5 - 35) 2 x (2.5 - 25)	1 x (10 - 95) 2 x (10 - 70)
Stranded		mm <sup>2</sup>	–	1 x 16	1 x (16 - 50) 2 x (16 - 35)	1 x (16 - 120) 2 x (16 - 95)
Solid or stranded		AWG	18 - 14	18 - 6	12 - 2	8 - 250MCM
Flat conductor	Number of layers x width x thickness	mm	–	–	2 x (6 x 9 x 0.8)	2 x (6 x 16 x 0.8)
Terminal capacity of control circuit cable						
Solid		mm <sup>2</sup>	1 x (0.75 - 4) 2 x (0.75 - 2.5)	1 x (0.75 - 4) 2 x (0.75 - 2.5)	1 x (0.75 - 4) 2 x (0.75 - 4)	1 x (0.75 - 4) 2 x (0.75 - 4)
Flexible with ferrule		mm <sup>2</sup>	1 x (0.75 - 2.5) 2 x (0.75 - 2.5)	1 x (0.75 - 2.5) 2 x (0.75 - 2.5)	1 x (0.75 - 2.5) 2 x (0.75 - 2.5)	1 x (0.75 - 2.5) 2 x (0.75 - 2.5)
Solid or stranded		AWG	18 - 14	18 - 14	18 - 14	18 - 14
Main cable connection screw/bolt			M3.5	M5	M6	M10
Tightening torque		Nm	1.2	3	3.3	14
Control circuit cable connection screw/bolt			M3.5	M3.5	M3.5	M3.5
Tightening torque		Nm	1.2	1.2	1.2	1.2
<b>Tools</b>						
<b>Main conductors</b>						
Pozidriv screwdriver		Size	2	2	2	–
Internal hexagon	SW	mm	–	–	–	5
Flat-blade screwdriver		mm	0.8 x 5.5 1 x 6	0.8 x 5.5 1 x 6	0.8 x 5.5 1 x 6	–
<b>Auxiliary conductors</b>						
Pozidriv screwdriver		Size	2	2	2	2
Flat-blade screwdriver		mm	0.8 x 5.5 1 x 6	0.8 x 5.5 1 x 6	0.8 x 5.5 1 x 6	0.8 x 5.5 1 x 6

**DILMP20 ... DILMP200**

				DILMP20	DILMP32 DILMP45		DILMP63 DILMP80	DILMP125 DILMP160 DILMP200					
<b>Main contacts</b>													
Rated impulse withstand voltage	$U_{imp}$	V AC		8000									
Overvoltage category/pollution degree				III/3									
Rated insulation voltage	$U_i$	V AC		690									
Rated operating voltage	$U_e$	V AC		690									
Safe isolation according to EN 61140													
Between coil and contacts			V AC	400	440								
Between the contacts			V AC	400	440								
Making capacity (cos $\phi$ to IEC/EN 60947)	To 690 V	A		144	238	350	560	700	1120	1330	1800		
Breaking capacity													
220/230 V		A		120	180	250	400	500	800	950	1150		
380/400 V		A		120	180	250	400	500	800	950	1150		
500 V		A		100	180	250	400	500	800	950	1150		
660/690 V		A		70	120	144	250	296	650	750	800		
Short-circuit rating													
Short-circuit protection rating maximum fuse													
Type "2" coordination													
400 V			gG/gL 500 V	A	20	35	35	63	80	160	160	250	
690 V			gG/gL 690 V	A	20	35	35	50	63	160	160	200	
Type "1" coordination													
400 V			gG/gL 500 V	A	35	63	100	125	160	250	250	250	
690 V			gG/gL 690 V	A	25	50	50	80	80	200	200	200	
<b>AC voltage</b>													
AC-1 operation													
Conventional thermal current 3 pole 50 - 60 Hz													
Open													
at 40 °C			$I_{th}$	A	22	32	45	63	80	125	160	200	
at 50 °C			$I_{th}$	A	21	30	41	60	76	116	150	188	
at 60 °C			$I_{th}$	A	20	28	39	54	69	108	138	172	
Enclosed				$I_{th}$	A	18	27	36	50	64	100	128	160
Conventional thermal current, 1 pole													
Open				$I_{th}$	A	60	84	117	162	207	325	415	516
Enclosed				$I_{th}$	A	54	76	105	146	186	292	373	464
Rated operational power													
220/230 V	P	kW		8	12	16	23	29	45	58	72		
240 V	P	kW		9	13	18	25	32	49	63	79		
380/400 V	P	kW		14	20	28	39	50	78	100	125		
415 V	P	kW		15	22	31	43	55	85	109	137		
440 V	P	kW		16	23	33	46	58	90	116	145		
500 V	P	kW		18	26	37	52	66	103	132	165		
690 V	P	kW		24	35	49	68	87	136	174	217		
AC-3 operation													
Rated operational current AC -3 open, 50 – 60 Hz, 3 pole													
220/230 V	$I_e$	A		12	18	25	40	50	80	95	115		
240 V	$I_e$	A		12	18	25	40	50	80	95	115		
380/400 V	$I_e$	A		12	18	25	40	50	80	95	115		
415 V	$I_e$	A		12	18	25	40	50	80	95	115		
440 V	$I_e$	A		12	18	25	40	50	80	95	115		
500 V	$I_e$	A		10	18	25	40	50	80	95	115		
660/690 V	$I_e$	A		7	12	15	25	32	65	80	93		
Rated operational power													
220/230 V	P	kW		3.5	5	7.5	12.5	15.5	25	30	37		
240 V	P	kW		4	5.5	8.5	13.5	17	27.5	33	40		
380/400 V	P	kW		5.5	7.5	11	18.5	22	37	45	55		
415 V	P	kW		7	10	14.5	24	30	48	57	70		
440 V	P	kW		7.5	10.5	15.5	25	32	51	60	75		
500 V	P	kW		7	12	17.5	28	36	58	70	85		
660/690 V	P	kW		6.5	11	14	23	30	63	75	90		

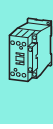

				DILMP20	DILMP32 DILMP45		DILMP63 DILMP80		DILMP125 DILMP160 DILMP200		
<b>DC voltage</b>											
Rated operational current $I_e$ open											
DC-1 operation											
60 V	$I_e$	A	22	32	45	63	80	125	160	200	
110 V	$I_e$	A	22	32	45	63	80	125	160	200	
220 V	$I_e$	A	6	32	45	63	80	125	160	200	
440 V	$I_e$	A	1.3	3	3	5	5	10	10	10	
DC-3 operation											
60 V	$I_e$	A	20	32	45	63	80	125	160	200	
110 V	$I_e$	A	20	32	45	63	80	125	160	200	
220 V	$I_e$	A	1.5	32	45	63	80	125	160	200	
440 V	$I_e$	A	0.2	6	6	8	8	9	9	9	
DC-5 operation											
60 V	$I_e$	A	20	32	45	63	80	125	160	200	
110 V	$I_e$	A	20	25	32	50	80	125	160	200	
220 V	$I_e$	A	1.5	15	22	38	70	100	125	150	
440 V	$I_e$	A	0.2	4	4	8	8	8	8	8	
<b>Current heat loss (3 pole)</b>											
Current heat loss at $I_{th}$				4.7	8.2	12	16	23	29	46	60
Impedance per pole				2.5	2	1.5	1	0.7	0.6	0.6	0.5
<b>Magnet systems</b>											
Voltage tolerance											
AC operated 50 Hz	Pick-up	$x U_c$	0.8 - 1.1	0.8 - 1.1		0.8 - 1.1		0.8 - 1.1			
AC operated 50/60 Hz		$x U_c$	0.8 - 1.1	0.85 - 1.1		0.85 - 1.1		0.8 - 1.1			
AC operated	Drop-out	$x U_c$	0.4 - 0.6	0.4 - 0.6		0.4 - 0.6		0.4 - 0.6			
DC operated <sup>1)</sup>	Pick-up	$x U_c$	0.8 - 1.1	0.7 - 1.2		0.7 - 1.2		0.7 - 1.2			
DC operated <sup>1)</sup>	Drop-out	$x U_c$	0.2 - 0.6	0.2 - 0.6		0.2 - 0.6		0.2 - 0.6			
Power consumption of the coil in a cold state and $1.0 \times U_c$											
AC operated 50/60 Hz	Pick-up	VA	24	50		150		180			
AC operated 50/60 Hz	Pick-up	W	19	40		95		150			
AC operated 50/60 Hz	Sealing	VA	4	8		16		3.1			
AC operated 50/60 Hz	Sealing	W	1.2	2.4		4		2.1			
DC operated <sup>1)</sup>	Pick-up	W	4.5	12		24		149			
DC operated <sup>1)</sup>	Sealing	W	4.5	0.5		0.5		2.1			
Duty factor				100	100		100		100		
Changeover times at 100 % $U_c$ (recommended values)											
Main contacts											
AC operated											
	Closing delay	ms	15...21	16...22		12...18		28...33			
	Opening delay	ms	9...18	8...14		8...13		35...41			
DC operated <sup>1)</sup>											
	Closing delay	ms	31	47		54		35			
	Opening delay	ms	12	30		24		30			
Arcing time				10	10		10		15		
Permissible residual current when A1 - A2 are actuated from the electronic system (with 0 signal)				$\leq 1$	$\leq 1$		$\leq 1$		$\leq 1$		

## Notes

<sup>1)</sup> At least double-pulse bridge rectifier

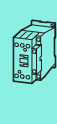

			DILK12	DILK20	DILK25	DILK33	DILK50	
<b>General</b>								
Standards			IEC/EN 60947, VDE 0660					
Ambient temperature								
Open		°C	-25...60	-25...60	-25...60	-25...60	-25...60	
Enclosed		°C	-25...40	-25...40	-25...40	-25...40	-25...40	
Mounting position								
Protection type			IP00	IP00	IP00	IP00	IP00	
Protection against direct contact when actuated from front (EN 50274)			Finger- and back-of-hand proof					
Weight basic device								
AC operated		kg	0.55	0.55	0.55	1	1	
Terminal capacity of main cable								
Solid		mm <sup>2</sup>	1 x (0.75 - 16)	1 x (0.75 - 16)	1 x (0.75 - 16)	1 x (2.5 - 16)	1 x (2.5 - 16)	
Flexible with ferrule		mm <sup>2</sup>	1 x (0.75 - 16)	1 x (0.75 - 16)	1 x (0.75 - 16)	1 x (2.5 - 35)	1 x (2.5 - 35)	
Stranded		mm <sup>2</sup>	1 x 16	1 x 16	1 x 16	1 x (16 - 50)	1 x (16 - 50)	
Solid or stranded		AWG	18 - 16	18 - 6	18 - 6	12 - 2	12 - 2	
Flat conductor	Number of layers x width x thickness	mm	-	-	-	1 x (6 x 9 x 0.8)	1 x (6 x 9 x 0.8)	
<b>Group compensation</b>								
60 Hz								
230 V		kvar	7.5	11	15	20	25	
400 V		kvar	12.5	20	25	33.3	50	
525 V		kvar	16.7	25	33.3	40	65	
690 V		kvar	20	33.3	40	55	85	
50/60 Hz								
Open								
230 V	$I_e$	A	18	29	38	50	72	
400 V	$I_e$	A	18	29	38	50	72	
525 V	$I_e$	A	18	29	38	50	72	
690 V	$I_e$	A	18	29	38	50	72	
Enclosed								
230 V	$I_e$	A	16	26	34	45	65	
400 V	$I_e$	A	16	26	34	45	65	
525 V	$I_e$	A	16	26	34	45	65	
690 V	$I_e$	A	16	26	34	45	65	
Making capacity (i-peak value) without damping			$x I_e$	180	180	180	180	180
Component lifespan			c (contacts)	$x 10^6$	0.15	0.15	0.15	0.15
Maximum operating frequency			Ops/h	120	120	120	120	120

			DILK12	DILK20	DILK25	DILK33	DILK50
<b>Magnet systems</b>							
Voltage tolerance							
AC operated	Pick-up	$x U_c$	0.8 - 1.1	0.8 - 1.1	0.8 - 1.1	0.8 - 1.15	0.8 - 1.15
AC operated	Drop-out	$x U_c$	0.3 - 0.6	0.3 - 0.6	0.3 - 0.6	0.3 - 0.6	0.3 - 0.6
Power consumption of the coil in a cold state and $1.0 x U_c$							
50 Hz	Pick-up	VA	58	58	58	45	45
50 Hz	Sealing	VA	7.6	7.6	7.6	1.5	1.5
50 Hz	Sealing	W	2.3	2.3	2.3	1.5	1.5
60 Hz	Pick-up	VA	71	71	71	45	45
60 Hz	Sealing	VA	9.3	9.3	9.3	1.5	1.5
60 Hz	Sealing	W	2.8	2.8	2.8	1.5	1.5
50/60 Hz	Pick-up	VA	65 59	65 59	65 59	45 45	45 45
50/60 Hz	Sealing	VA	9.6 7	9.6 7	9.6 7	1.5 1.5	1.5 1.5
50/60 Hz	Sealing	W	2.7 2.2	2.7 2.2	2.7 2.2	1.5 1.5	1.5 1.5
Duty factor		% DF	100	100	100	100	100
Changeover times at 100 % $U_c$ (recommended values)							
Main contacts							
AC operated							
	Closing delay	ms	16...22	16...22	16...22	50	50
	Opening delay	ms	8...14	8...14	8...14	40	40
Arcing time		ms	10	10	10	10	10
<b>Electromagnetic compatibility (EMC)</b>							
Emitted interference			To EN 60947-1	To EN 60947-1	To EN 60947-1	To EN 60947-1	To EN 60947-1
Interference immunity			To EN 60947-1	To EN 60947-1	To EN 60947-1	To EN 60947-1	To EN 60947-1
<b>Further technical data</b>							
As per contactor	DIL		M17	M25	M32	M50	M65

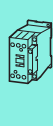

				DILL12	DILL18	DILL20	
<b>General</b>							
Standards				IEC/EN 60947, VDE 0660, UL, CSA			
Lifespan, mechanical							
AC operated	c (contacts)	x 10 <sup>6</sup>		1	1	1	
Operating frequency, mechanical							
Mechanical, AC operated	Operations/h			60	60	60	
Maximum operating frequency							
Electrical	Operations/h			60	60	60	
Climatic proofing				Damp heat, constant, to IEC 60068-2-78; Damp heat, cyclic, to IEC 60068-2-30			
Ambient temperature	Open	°C		-25...60	-25...60	-25...60	
	Enclosed	°C		-25...40	-25...40	-25...40	
	Storage	°C		-40 - 80	-40 - 80	-40 - 80	
Mounting position							
Mechanical shock resistance (IEC/EN 60068-2-27)							
Half-sinusoidal shock 10 ms				6.9	6.9	6.9	
Protection type				IP00	IP00	IP00	
Weight							
AC operated		kg	0.42	0.42	0.42		
<b>Main contacts</b>							
Rated impulse withstand voltage	U <sub>imp</sub>	V AC	8000	8000	8000		
Overvoltage category/pollution degree			III/3	III/3	III/3		
Rated insulation voltage	U <sub>i</sub>	V AC	690	690	690		
Rated operating voltage	U <sub>e</sub>	V AC	690	690	690		
Making capacity		A	238	350	550		
Breaking capacity	380/400 V	A	170	250	320		
Lifespan, electrical	c (contacts)		10000	10000	10000		
Short-circuit protection rating maximum fuse							
400 V	gG/gL 500 V	A	63	100	125		
<b>AC voltage</b>							
AC-1 operation							
Conventional thermal current							
	at 40 °C	I <sub>th</sub>	A	27	40	45	
	at 60 °C	I <sub>th</sub>	A	24	35	40	
230 V		I <sub>e</sub>	A	12	18	20	
400 V		I <sub>e</sub>	A	12	18	20	
AC-1 operation							
220/230 V		I <sub>e</sub>	A	14	21	27	
400 V		I <sub>e</sub>	A	14	21	27	
Electric lamps							
Filament bulbs				A	14	21	27
Mercury blended lamps				A	12	16	23
Fluorescent lamp load							
	Conventional reactor starter connection	A	20	26	35		
	Duo circuit	A	20	26	35		
Electronic upstream devices				A	12	18	20
High-pressure mercury vapour lamps				A	12	18	20
Metal-halide lamps				A	12	18	20
High-pressure sodium lamps				A	12	18	20
Low-pressure sodium lamps				A	7.5	10	12
Maximum permissible compensation capacitance				μF	470	470	470
<b>Further technical data</b>							
As per contactor				DIL	M17	M25	M32



				DILMF8	DILMF11	DILMF14	DILMF17
<b>General</b>							
Mounting position							
<b>AC voltage</b>							
AC-3 operation							
Rated operational current AC -3 open, 50 – 60 Hz, 3 pole	220/230 V	$I_e$	A	7	9	12	18
	240 V	$I_e$	A	7	9	12	18
	380/400 V	$I_e$	A	7	9	12	18
	415 V	$I_e$	A	7	9	12	18
	440 V	$I_e$	A	7	9	12	18
	500 V	$I_e$	A	5	7	10	18
	660/690 V	$I_e$	A	4	5	7	12
	Rated operational power						
	220/230 V	P	kW	2.2	2.5	3.5	5
	240 V	P	kW	2.2	3	4	5.5
380/400 V	P	kW	3	4	5.5	7.5	
415 V	P	kW	4	5.5	7	10	
440 V	P	kW	4.5	5.5	7.5	10.5	
500 V	P	kW	3.5	4.5	7	12	
660/690 V	P	kW	3.5	4.5	6.5	11	
AC-4 operation							
Rated operational current AC-4 open, 50 - 60 Hz, 3 pole	220/230 V	$I_e$	A	5	6	7	10
	240 V	$I_e$	A	5	6	7	10
	380/400 V	$I_e$	A	5	6	7	10
	415 V	$I_e$	A	5	6	7	10
	440 V	$I_e$	A	5	6	7	10
	500 V	$I_e$	A	4.5	5	6	10
	660/690 V	$I_e$	A	4	4.5	5	8
	Rated operational power						
220/230 V	P	kW	1	1.5	2	2.5	
240 V	P	kW	1.5	1.6	2.2	3	
380/400 V	P	kW	2.2	2.5	3	4.5	
415 V	P	kW	2.3	2.8	3.4	5	
440 V	P	kW	2.4	3	3.6	5.5	
500 V	P	kW	2.5	2.8	3.5	6	
660/690 V	P	kW	2.9	3.6	4.4	6.5	
<b>Current heat loss (3 pole)</b>							
Current heat loss at $I_{th}$			W	2.4	2.4	2.4	7.3
Current heat loss at $I_e$ to AC-3/400 V			W	0.3	0.6	1	1.9
<b>Magnet systems</b>							
Voltage tolerance	AC operated	Pick-up	$x U_c$	0.8 - 1.15	0.8 - 1.15	0.8 - 1.15	0.8 - 1.15
	AC operated	Drop-out	$x U_c$	0.2 - 0.5	0.2 - 0.5	0.2 - 0.5	0.2 - 0.5
Power consumption of the coil in a cold state and $1.0 \times U_c$	Electronic actuation	Pick-up	VA	14	14	14	14
		Sealing	VA	0.7	0.7	0.7	0.7
	Electronic actuation	Sealing	W	0.7	0.7	0.7	0.7
Duty factor			% DF	100	100	100	100
Switching times	Closing delay		ms	40	40	40	40
	Opening delay		ms	45	45	45	45
suitable according to				SEMI F47	SEMI F47	SEMI F47	SEMI F47
<b>Electromagnetic compatibility (EMC)</b>							
Emitted interference				To EN 60947-1			
Interference immunity				To EN 60947-1			
<b>Further technical data</b>							
As per contactor			DIL	M7	M9	M12	M17
<b>Terminal type</b>							
As per contactor			DIL	M17	M17	M17	M17

DILMF25	DILMF32	DILMF40	DILMF50	DILMF65	DILMF80	DILMF95	DILMF115	DILMF150
25	32	40	50	65	80	95	115	150
25	32	40	50	65	80	95	115	150
25	32	40	50	65	80	95	115	150
25	32	40	50	65	80	95	115	150
25	32	40	50	65	80	95	115	150
25	32	40	50	65	80	95	115	150
15	18	25	32	37	65	80	93	100
7.5	10	12.5	15.5	20	25	30	37	48
8.5	11	13.5	17	22	27.5	4	40	52
11	15	18.5	22	30	37	45	55	75
14.5	19	24	30	39	48	57	70	91
15.5	20	25	32	41	51	60	75	95
17.5	23	28	36	47	58	70	85	110
14	17	23	30	35	63	75	90	96
13	15	18	21	25	40	50	55	65
13	15	18	21	25	40	50	55	65
13	15	18	21	25	40	50	55	65
13	15	18	21	25	40	50	55	65
13	15	18	21	25	40	50	55	65
13	15	18	21	25	40	50	55	65
10	12	14	17	20	27	37	45	50
3.5	4	5	6	7	12	16	17	20
4	4.5	5.5	6.5	7.5	13	17	19	22
6	7	9	10	12	20	26	28	33
6.5	7.5	9.5	11	13	24	30	33	39
7	8	10	12	14	25	32	35	41
8	9	11	13	16	29	36	40	47
8.5	10	12	14	17	26	35	43	48
9.6	12.1	11.3	19	28.8	14.6	21.8	30.4	46.1
3.8	6.1	7.2	11.3	19	11.5	16.2	23.8	40.5
0.8 - 1.15	0.8 - 1.15	0.8 - 1.15	0.8 - 1.15	0.8 - 1.15	0.8 - 1.15	0.8 - 1.15	0.8 - 1.15	0.8 - 1.15
0.2 - 0.5	0.2 - 0.5	0.2 - 0.5	0.2 - 0.5	0.2 - 0.5	0.2 - 0.5	0.2 - 0.5	0.2 - 0.5	0.2 - 0.5
14	14	45	45	45	75	75	180	180
0.7	0.7	1.5	1.5	1.5	2	2	3.1	3.1
0.7	0.7	1.5	1.5	1.5	2	2	2.1	2.1
100	100	100	100	100	100	100	100	100
40	40	50	50	50	55	55	40	40
45	45	45	45	45	40	40	40	40
SEMI F47	SEMI F47	SEMI F47	SEMI F47	SEMI F47	SEMI F47	SEMI F47	SEMI F47	SEMI F47
To EN 60947-1								
To EN 60947-1								
M25	M32	M40	M50	M65	M80	M95	M115	M150
M25	M32	M40	M50	M65	M80	M95	M115	M150

			DILM7-... - DILM38-...	DILA- XHI(C)...(-S)	DILM32- XHI(C)...(-S)	DILM150- XHI...	DILM1000-XHI... DILM820-XHI...		
<b>Auxiliary contact</b>									
Interlocked opposing contacts within an auxiliary contact module (to IEC 60947-5-1 Annex L) <sup>1)</sup>			-	Yes	Yes	Yes	Yes		
Normally closed (not late-normally closed) suitable as a mirror contact (to IEC/EN 60947-4-1, Annex F)			DILM7 - DILM38	DILM7 - DILM38	DILM7 - DILM38	DILM40 - DILM170	DILM40 - DILM225A DILM250 - DILM1000		
Rated impulse withstand voltage	$U_{imp}$	V AC	6000	6000	6000	6000	6000		
Overvoltage category/pollution degree			III/3	III/3	III/3	III/3	III/3		
Rated insulation voltage	$U_i$	V AC	690	690	690	690	690		
Rated operating voltage	$U_e$	V AC	500	500	500	500	500		
Safe isolation according to EN 61140									
Between coil and auxiliary contacts		V AC	400	400	400	440	440		
Between the auxiliary contacts		V AC	400	400	400	440	440		
Rated operational current									
AC-15									
230 V	$I_e$	A	4	4	4	4	4		
380/415 V	$I_e$	A	4	4	4	4	4		
500 V	$I_e$	A	1.5	–	1.5	1.5	1.5		
DC L/R ≤ 15 ms <sup>2)</sup>									
24 V	$I_e$	A	10	10	10	10	10		
60 V	$I_e$	A	6	6	6	6	6		
110 V	$I_e$	A	3	3	3	3	3		
220 V	$I_e$	A	1	1	1	1	1		
DC-13 (6xP)									
Contacts in series:									
3	24 V	A	2.5	2.5	2.5	–	–		
3	60 V	A	1	1	1	–	–		
3	110 V	A	0.5	0.5	0.5	–	–		
3	220 V	A	0.25	0.25	0.25	–	–		
Conventional thermal current			$I_{th}$	A	10	16	16	10	
Control circuit reliability (at $U_e = 24$ V DC, $U_{min} = 17$ V, $I_{min} = 5.4$ mA)			Fault probability					$\lambda$	< 10 <sup>-8</sup> , < 1 one failure in 100 million operations
Component lifespan									
at $U_e = 230$ V, AC-15, 3 A		c (contacts)	x 10 <sup>6</sup>	1.3	1.3	1.3	1.3	1.3	
Short-circuit rating without welding									
Max. fuse		A gG/gL	10	10	10	16	16		

**Notes**<sup>1)</sup> Not with DIL...-XHIV and DIL...-XHICV.<sup>2)</sup> Switch-on and switch-off conditions based on DC-13, time constant as specified.

			P1DILEM DILM12-XP1	DILM32-XP1	DILM65-XP1	DILM150-XP1	DILM185-XP1
<b>Parallel connector</b>							
<b>Terminal capacity</b>							
Solid		mm <sup>2</sup>	1 - 16	16	16	–	–
Flexible with ferrule		mm <sup>2</sup>	1 x (0.5 - 25) 2 x (0.5 - 16)	1 x (16 - 35)	1 x (16 - 120)	–	–
Stranded		mm <sup>2</sup>	1 x (0.5 - 25) 2 x (0.5 - 16)	1 x (16 - 50)	1 x (16 - 120)	1 x (35 - 300) 2 x (35 - 120)	–
Flat conductor	Number of layers x width x thickness	mm	6 x 9 x 0.8	–	–	2 x (11 x 21 x 1)	1 x (6 x 16 x 0.8) 2 x (20 x 32 x 0.5) 2 x (11 x 21 x 1)
<b>Tightening torque</b>							
<b>Terminal capacity of control circuit cable</b>							
Solid		mm <sup>2</sup>	–	–	–	–	1 x (0.75 - 4) 2 x (0.75 - 4)
Flexible with ferrule		mm <sup>2</sup>	–	–	–	–	1 x (0.75 - 2.5) 2 x (0.75 - 2.5)
<b>Tools</b>							
Pozidriv screwdriver		Size	2	2	–	–	–
Internal hexagon	SW	mm	–	–	5	6	5
<b>Conventional thermal current</b>							
3 pole	I <sub>th</sub>	A	50	100	180	400	700
4 pole	I <sub>th</sub>	A	60	–	–	–	–

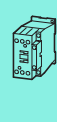

## Dimensions

### Mini contactor relays

DILER...(-C)  
DILER...-G(-C)

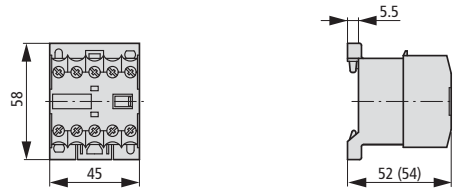

DILER...(-C) + ...DILE(-C)  
DILER...-G(-C) + ...DILE(-C)

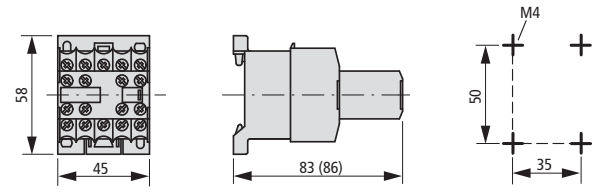

DILEEM-..., DILEM...(-C), DILEM-12-...  
DILEEM...-G, DILEM...-G(-C), DILEM-12...-G

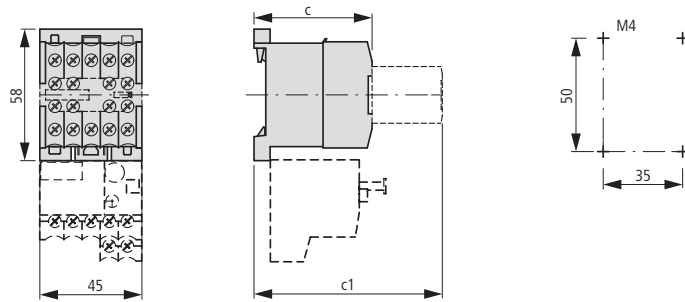

DILER... + HDILE  
DILER...-G + HDILE



### Suppressor circuit

RCDILE...  
VGDILE

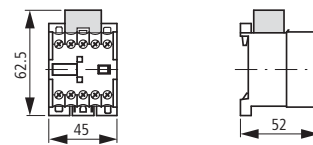

2DILE... + MVDILE  
2DILE...-G + MVDILE

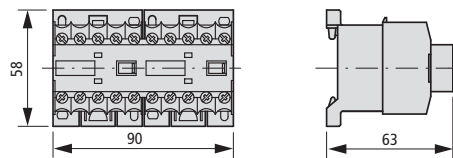

2DILE... + MVDILE + ...DILE  
2DILE...-G + MVDILE + ...DILE

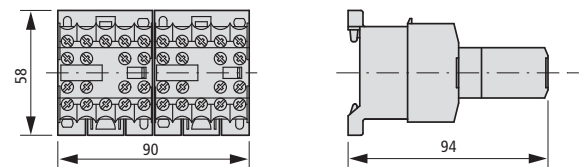

### Reversing contactors

DIULEM

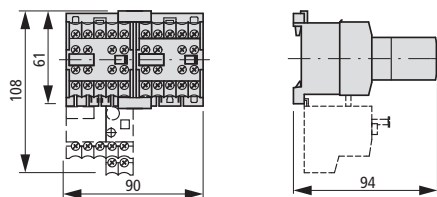

### Star-delta contactors

SDAINLEM

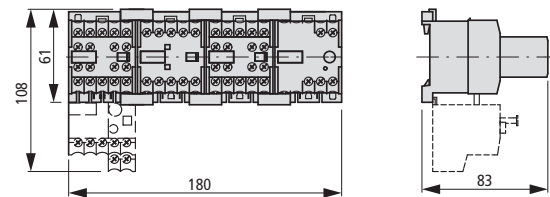

DILER... + TDDILE24

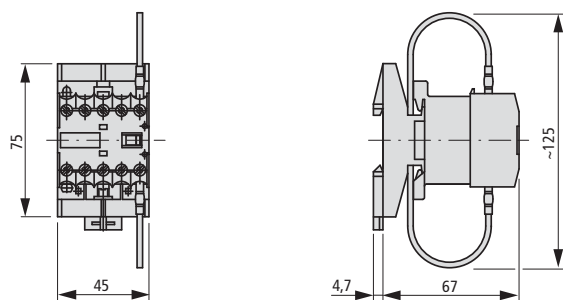

### Parallel connector

P1DILEM

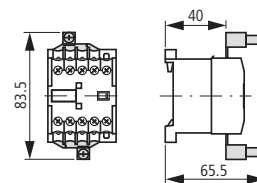

**Contactor with auxiliary contact module**

DILM7...DILM15

DILA...

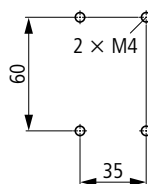
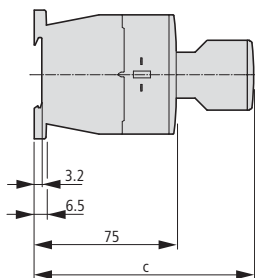
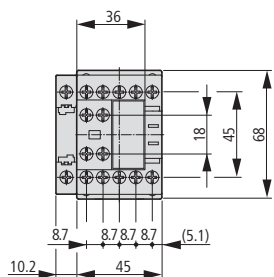

Part no.	c
DILM32-XHI	117
DILA-XHI	117
DILA-XHI...T	125

DILM7...DILM15

DILAC...

DILA-XHIC...

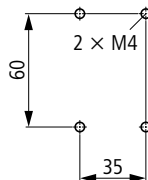
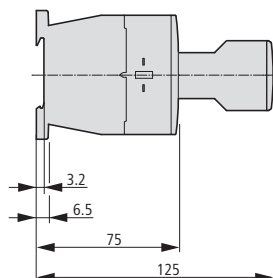
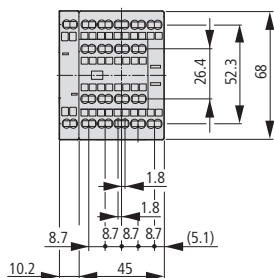

DILM17...DILM38

DILMC17...DILMC32

DILMF8...DILMF32

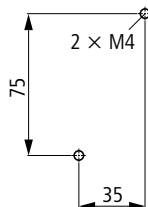
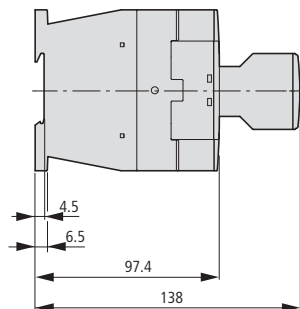
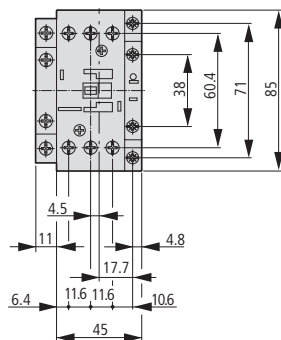

Clearance at side to grounded parts: 6 mm

**Contactors**

DILM40...DILM72  
 DILMC40...DILMC65  
 DILMF40...DILMF65

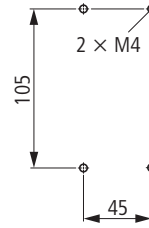
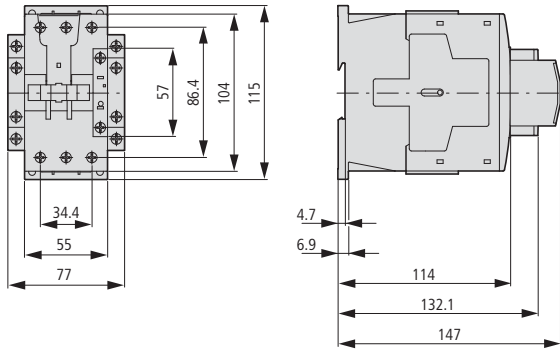
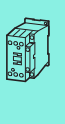

Clearance at side to grounded parts: 6 mm

DILM80...DILM170  
 DILMC80...DILMC150  
 DILMF80...DILMF150

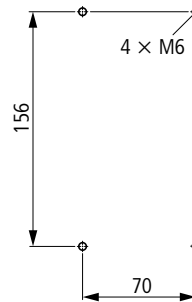
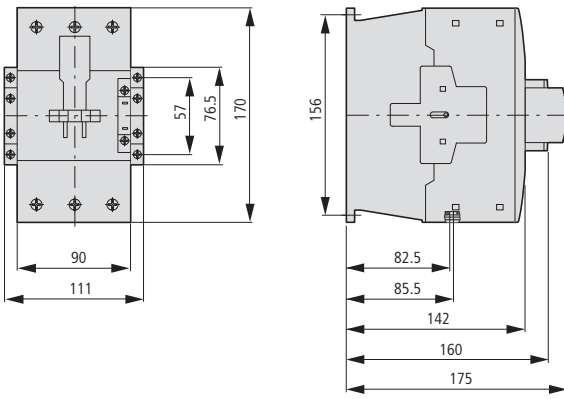

Clearance at side to grounded parts: 10 mm

**Suppressor circuits**

DILM...XSP...

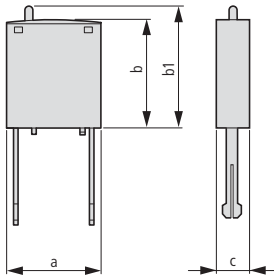

Part no.	a	b	b1	c
DILM12-XSP...	25	28	≈32	9
DILM32-XSP...	25	28	≈32	9
DILM95-XSP...	25	28	≈32	9

Contactor with auxiliary contact module

DILMP20

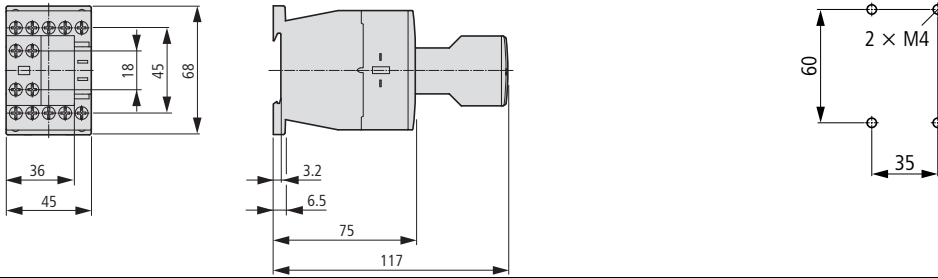

DILMP32 DILMP45

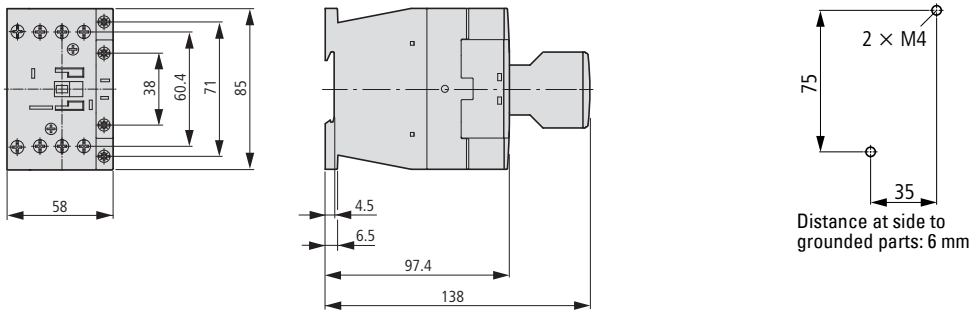

Contactors

DILMP63 DILMP80

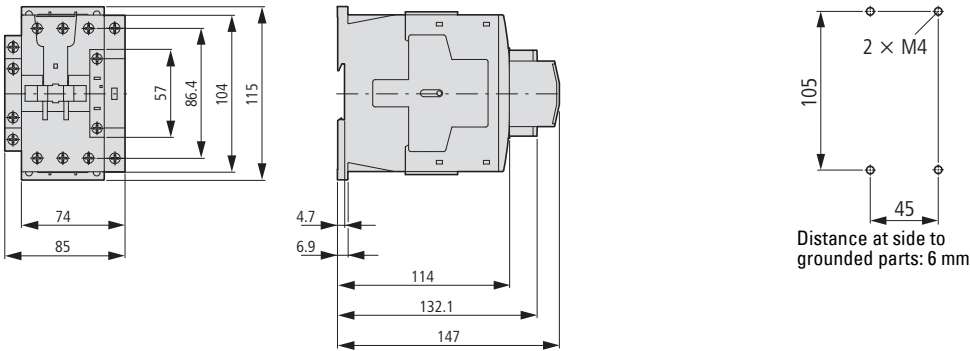

DILMP125 DILMP160 DILMP200

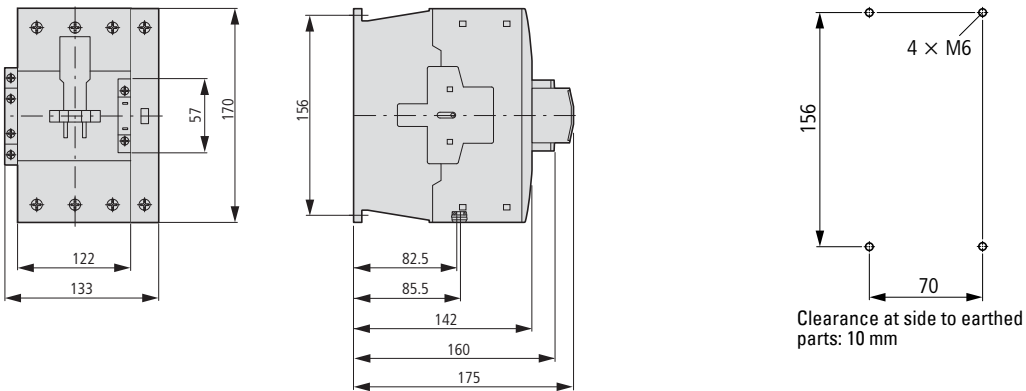

Motor suppressor module

DILM12-XMSM

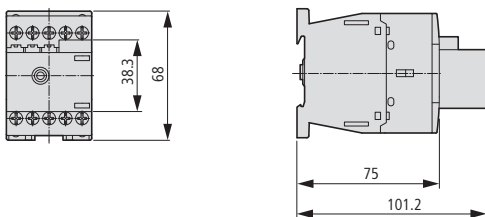

# 5/138 Contactors

Complete units for currents greater than 170 A

...DILM

## Complete units

DILM185A...DILM500  
DILM250-S...DILM570-S

① DILM1000-XHI...-SI  
② DILM1000-XHI11-SA

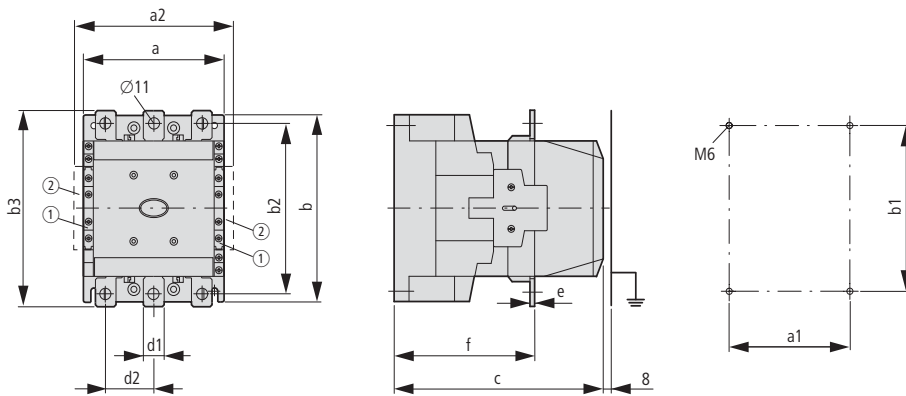

Part no.	a	a1	a2	b	b1	b2	b3	d1	d2	e	c	f
DILM185A	140	120	160	180	160	165	190	20	41	5	158	83
DILM225A	140	120	160	180	160	165	190	20	41	5	158	83
DILM250	140	120	160	180	160	164	189	25	48	5	208	140
DILM300A	140	120	160	180	160	164	189	25	48	5	208	140
DILM400	160	130	180	200	180	184	209	25	48	6	216	140
DILM500	160	130	180	200	180	189	219	38	57	6	216	140
DILM570	160	130	180	200	180	189	219	38	57	6	216	140

## DILM580...DILM1000

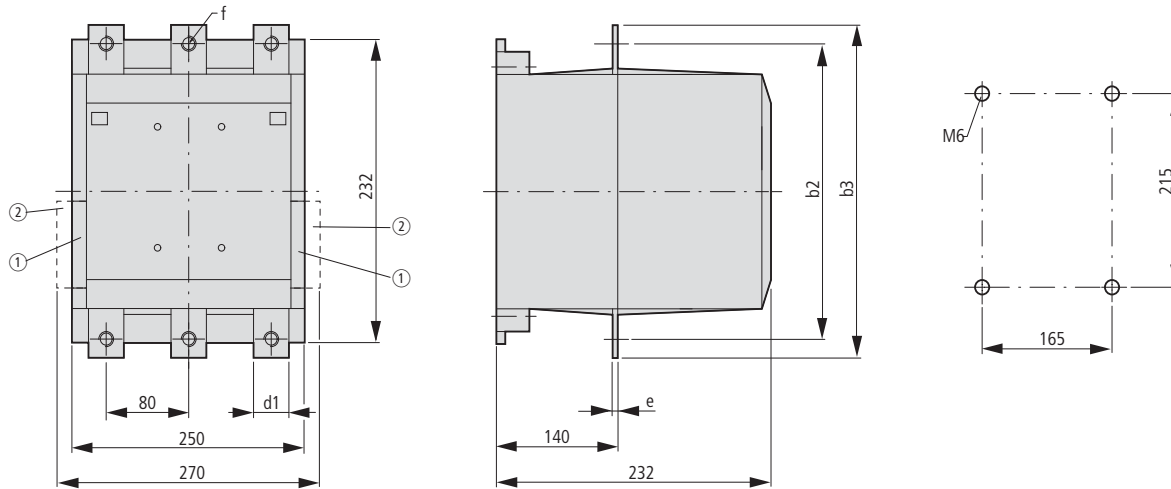

① DILM820-XHI...-SI  
② DILM820-XHI11-SA

Part no.	b2	b3	d1	e	f
DILM580	256	296	45	6	13.5
DILM650	256	296	45	6	13.5
DILM750	256	296	45	6	13.5
DILM820	256	296	45	6	13.5
DILM1000	256	296	45	10	13.5



AC-1 contactors greater than 1000 A

DILH1400

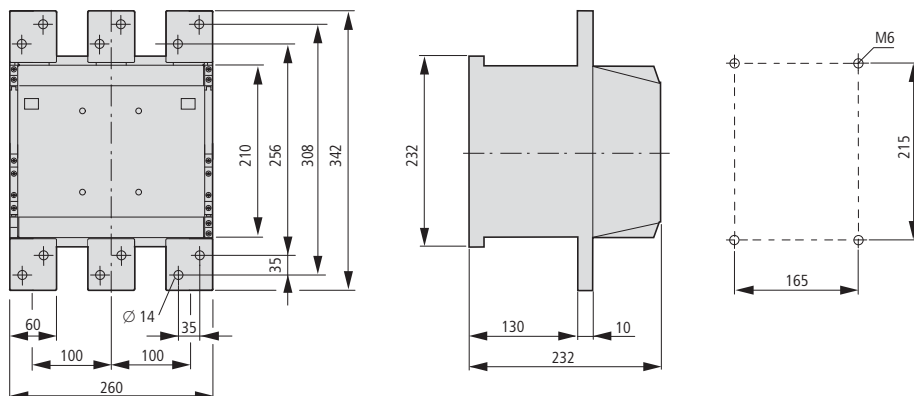

DILM1600

DILH2000

DILH2200

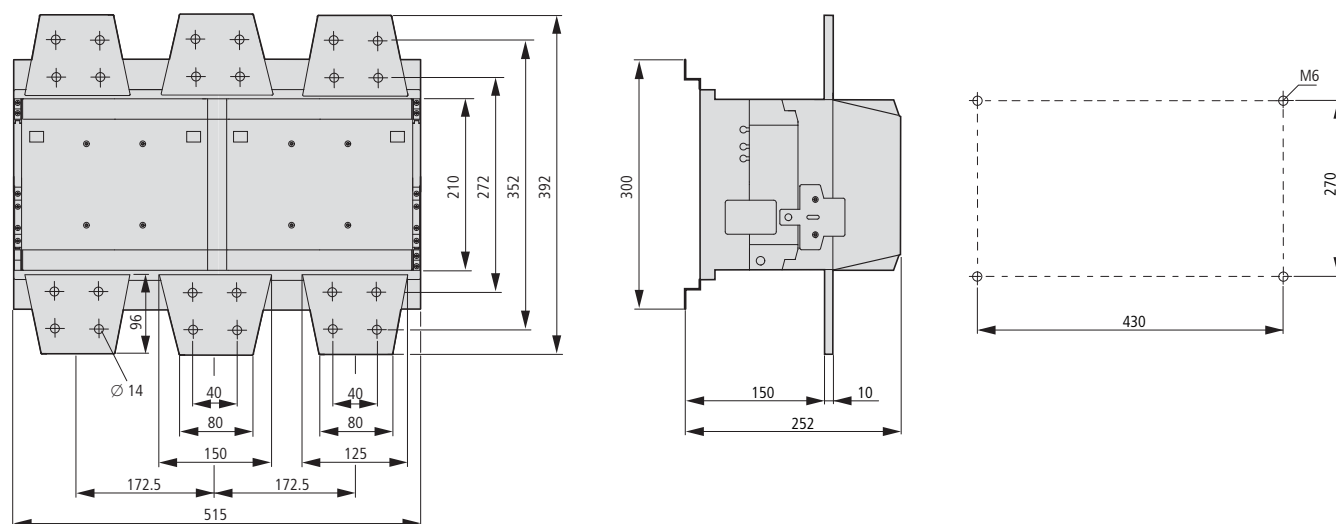

DILH2600

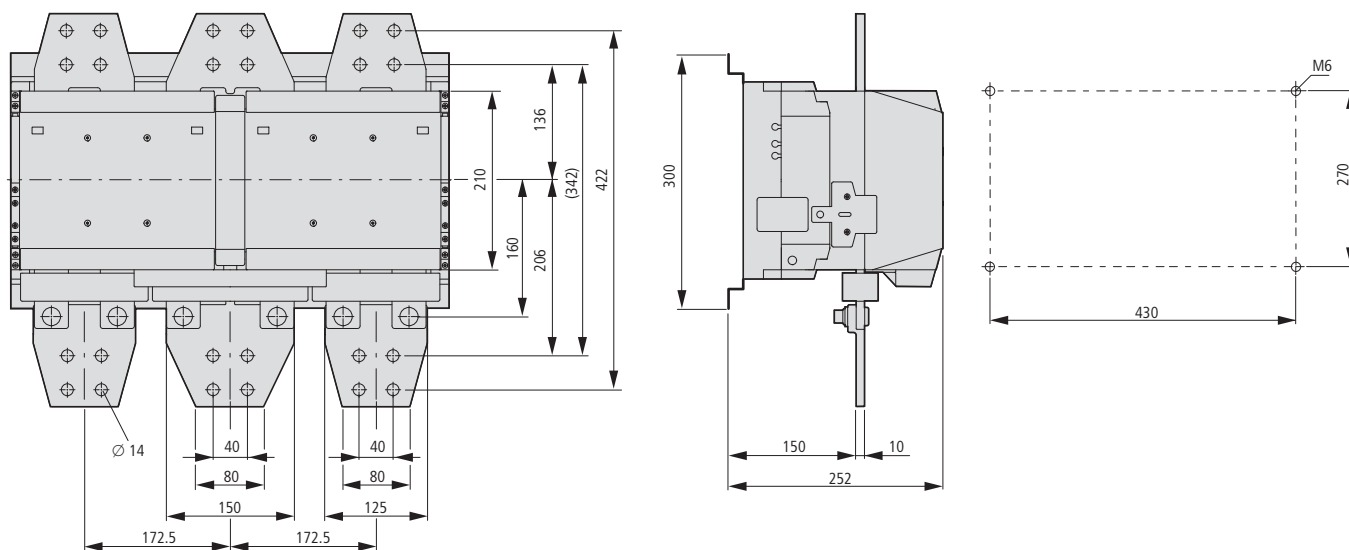

**Contactor for capacitors**

DILK...

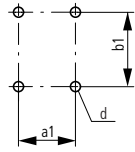
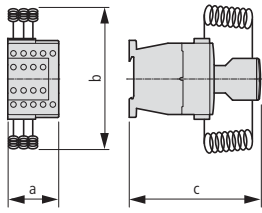

Part no.	a	b	c	a1	b1	d
DILK12	45	135	138	35	75	2 x M4
DILK20	45	135	138	35	75	2 x M4
DILK25	45	135	138	35	75	2 x M4
DILK33	55	190	147	45	105	2 x M4
DILK50	55	190	147	45	105	2 x M4

**Illumination contactors**

DILL...

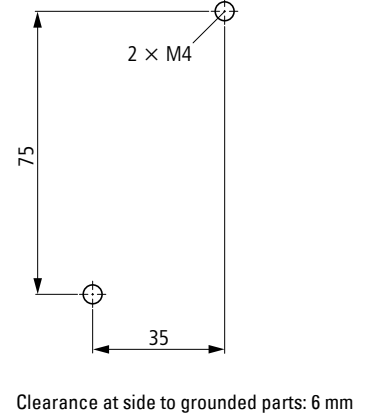
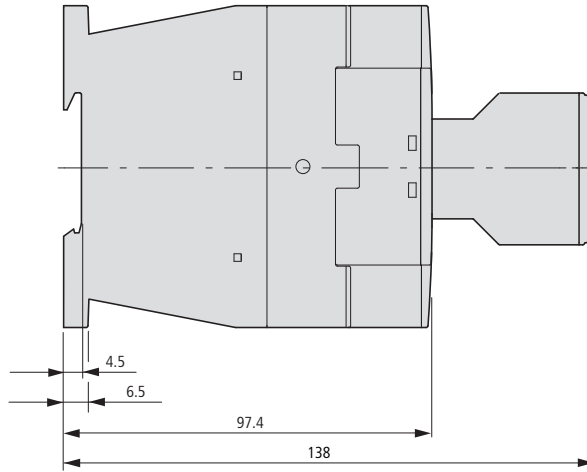
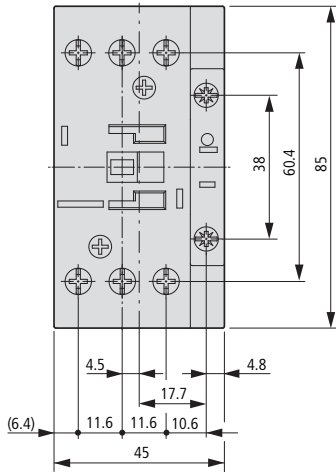

**Contactor monitoring devices**

CMD(...)

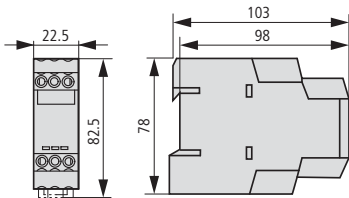

**SWD contactor modules**

DIL-SWD-32-...

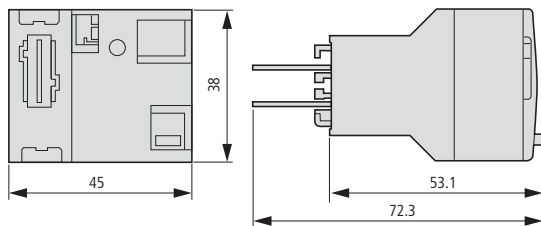

**Star-delta contactors**

SDAINLM12...SDAINLM115

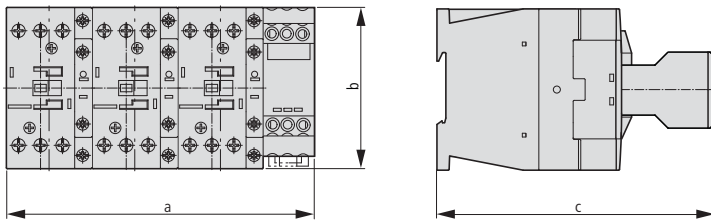

Part no.	a	b	c
SDAINLM12...22	158	68	117
SDAINLM30...55	158	85	138
SDAINLM70...115	188	115	147

SDAINLM140...SDAINLM260

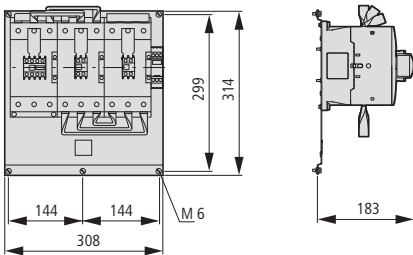

**Reversing contactors**

DIULM7...DIULM65

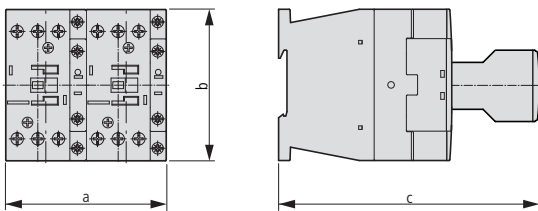

Part no.	a	b	c
DIULM7/21...12/21	90	68	117
DIULM17/21...32/21	90	85	138
DIULM40/11...65/11	110	115	147

DIULM80...DIULM150

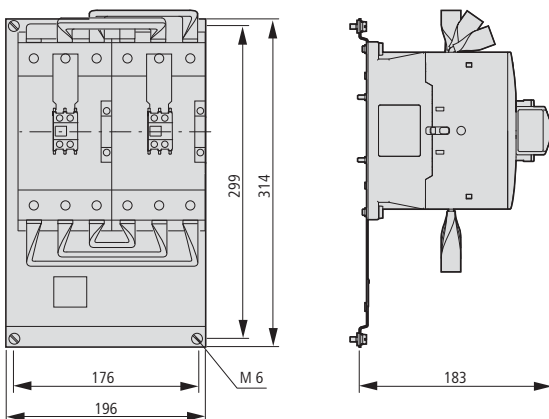

# 5/142 Contactors

## Accessories

**DILM...XDSB..., ETS4-VS3, DILM...XTE, DILM12-XMC...**

### Three-phase commoning links

DILM12-XDSB...

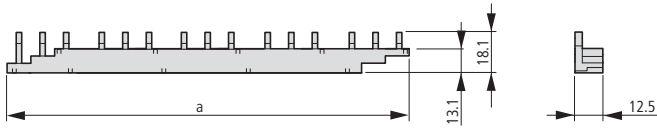

Part no.	a
DILM12-XDSB0/3	112
DILM12-XDSB0/4	157
DILM12-XDSB0/5	202

### Electronic timer modules

DILM...XTE

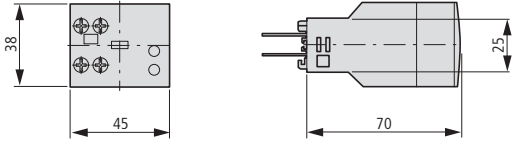

### Amplifier module

ETS4-VS3

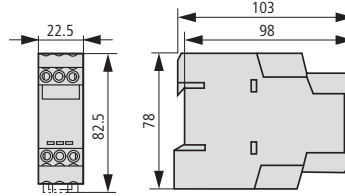

### Wiring set for motor feeder plug

DILM12-XMCE

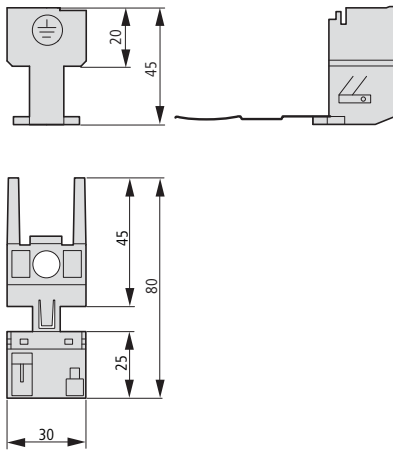

DILM12-XMCP/T

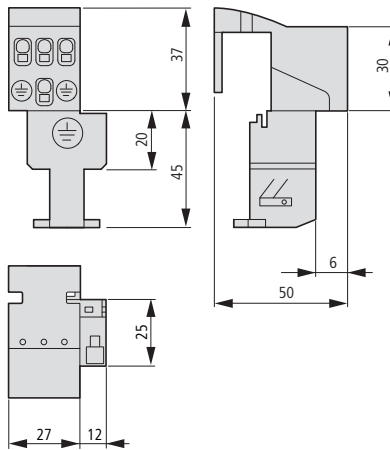

DILM12-XMCP/E

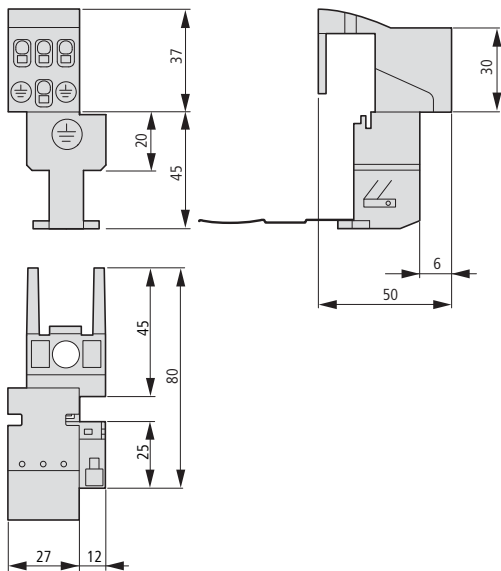

...DILM

Contactors with terminal shrouds

DILM250...DILM1000 + DILM...-XHB

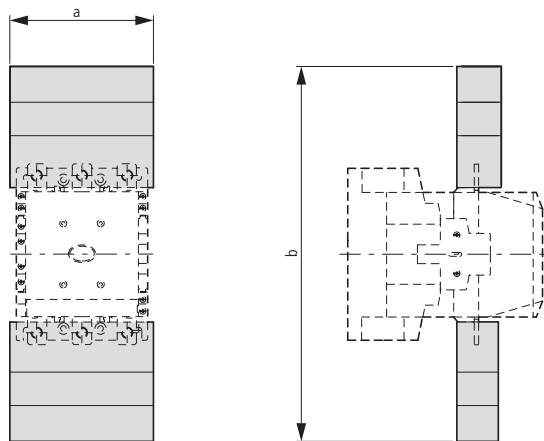

DILM250 + Z5.../FF250

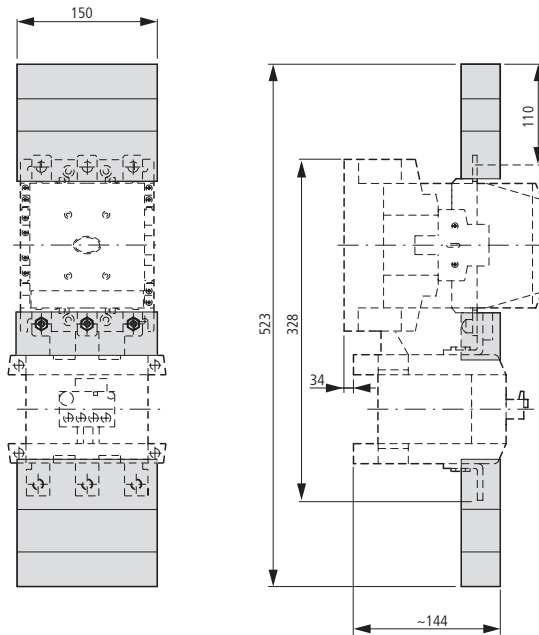

for part no.	a	b
DILM250, DILM300A	150	384
DILM400	150	404
DILM500	174	426
DILM580...1000	236	506

DILM185A...DILM225A + DILM225A-XHB

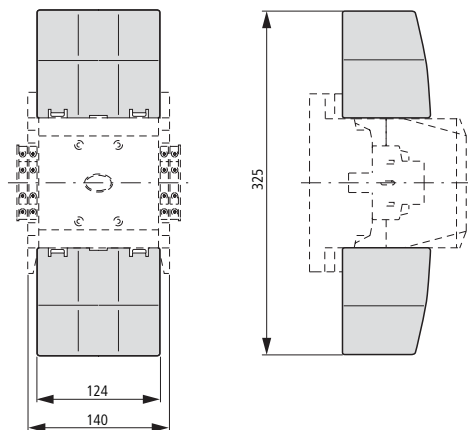

Contactor with star-point bridge and terminal shroud

DILM...XS1

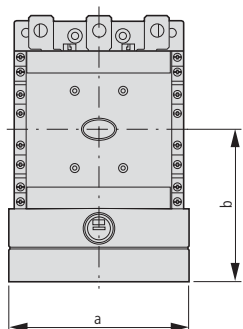

for part no.	a	b
DILM185...250	150	127
DILM300...400	150	137
DILM500	176	146

Mechanical interlock

DILM500-XMV

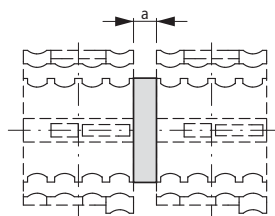

for part no.	a
DILM185...500	15

DILM820-XMV

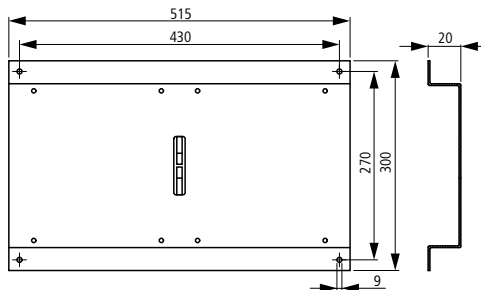



## DODIA ELECTRICALS

Our Own Brand



### AUTOMATION BRAND



### SWITCHGEAR BRAND



Address : 9/11, Picket 'X' Road, G.T. Building, Lohar Chawl, Mumbai - 400002.

Email id : sales@dodiaelectricals.com    Whats App / Contact : +91 98338 24773 / 022-22064807

Visit us at : [www.dodiaelectricals.com](http://www.dodiaelectricals.com)