

# Price List

w.e.f Jan.17<sup>th</sup>, 2024

# Schneider Electric



**DODIA ELECTRICALS**

## Final Distribution, Wiring Devices and Lighting Control Products



Life Is On

Schneider  
Electric

## Final Distribution, Wiring Devices and Lighting Control Products

[se.com/in](https://se.com/in)



**DODIA ELECTRICALS**

<b>Acti 9 Distribution System .....</b>	<b>4</b>
> Miniature Circuit Breakers (MCBs).....	8
> Residual Current Devices.....	11
> Auxiliaries and Accessories for MCBs / RCDs .....	13
> Surge Protection Devices.....	15
> Control and Command Products.....	17
> Control and Command Products.....	18
> ComReady Control and Command Products.....	19
> Isobar Distribution System .....	20
> Acti 9 Isobar Pan Assembly .....	22
> Acti 9 Distribution Boards.....	23
> Acti 9 Modular Distribution Boards - Metallic.....	27
<b>Kaedra Enclosures .....</b>	<b>34</b>
<b>PratiKa.....</b>	<b>36</b>
<b>Electra .....</b>	<b>40</b>
<b>56 Series .....</b>	<b>41</b>
<b>Wiring Devices .....</b>	<b>44</b>
> LIVIA - Switch to the extra-ordinary.....	46
> Clipsal X - As Stylish As Your World .....	48
> Opale - Switches with Satin Finish .....	52
> Unica Pure - Irresistibly Beautiful .....	54
> ZENcelo India - The Revolutionary Full-Flat Switch.....	63
> AvatarOn - It's also a Switch.....	67
> Kavacha - Weather Protected Series.....	74
> Metal Boxes .....	75
> Wiser.....	76
> Surface and Flush Mount Occupancy Sensors.....	77
> Dimmable Sensors with Light Regulation.....	77
> Wall Mount Sensors.....	78
> Hotel - ELV Dual Motion Sensor .....	78
> Timers & Time Switches .....	79

# Acti 9 | Advanced Communication Technology that Inspires

## > Protection devices

- Miniature circuit breakers
- Residual current circuit breakers
- Vigi™ residual current devices
- Surge Protection Devices

## > Protection monitoring and supervision

- Indication and tripping auxiliaries
- Remote control auxiliaries
- Automatic reclosure auxiliaries



Innovative  
Protection monitoring Total control and  
Metering @ DB level



Efficient  
Manage loads, reduce operating and project  
costs, and accurately plan maintenance

## > Control and monitoring

- Contactors
- Impulse relays
- Integrated control circuit breakers
- Light indicators
- Push-buttons and selector switches
- Kilowatt hour meters
- Communicating architecture

## > Installation system

- IP20B terminals
- Splitter blocks
- Full range of mounting and wiring accessories



Reliable

Dual certifications for one product, 100 percent MCB and RCD coordination, easy ordering and design, error free fast connections

# Acti 9 | Advanced Communication Technology that Inspires.....

## > Innovative

- Centralized control system including energy metering
- Large and variable data reading and computing through universal Modbus protocol

## > Efficient

- One-click, prefabricated wiring for comprehensive communication between your distribution board or panel and any facility management system

## > Reliable

- Error proof connection leading to reduction in downtime
- EMC tested for immunity, radiated and conducted safety

**NEW**

Email Notification upon Event (Devices Status Change, Alarm threshold reached etc.)

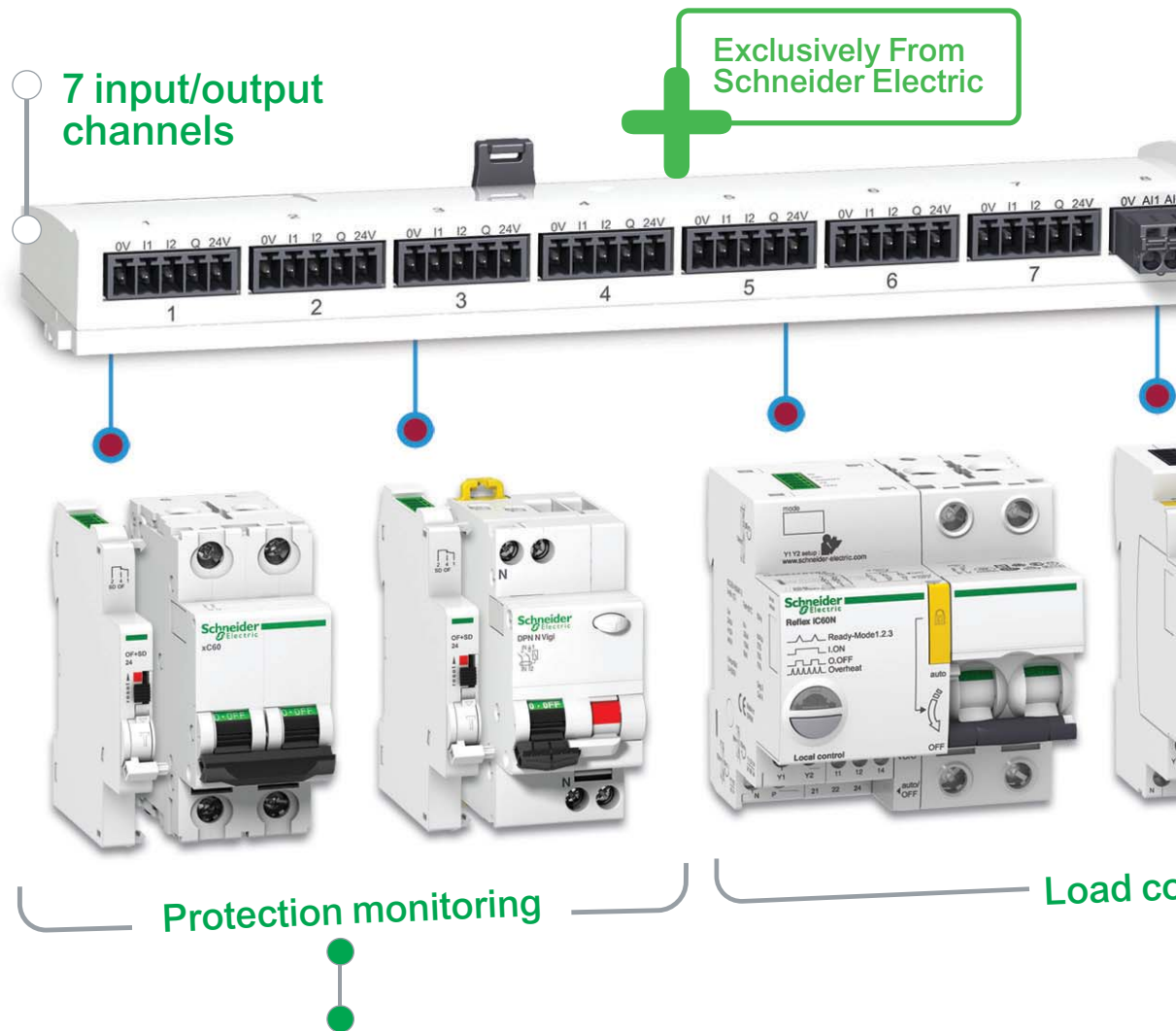

- > Status Monitoring - ON / OFF / TRIP
- > Trip Alarm Indication
- > Load Monitoring - No. of tripping cycles, Running Hours

- > Switching Action - ON / OFF
- > Monitoring - No. of Switching running hours



Meets the challenge of all your applications  
Detailed load control, reduced downtime and accurately planned maintenance

# Ready to connect to any facility management solution

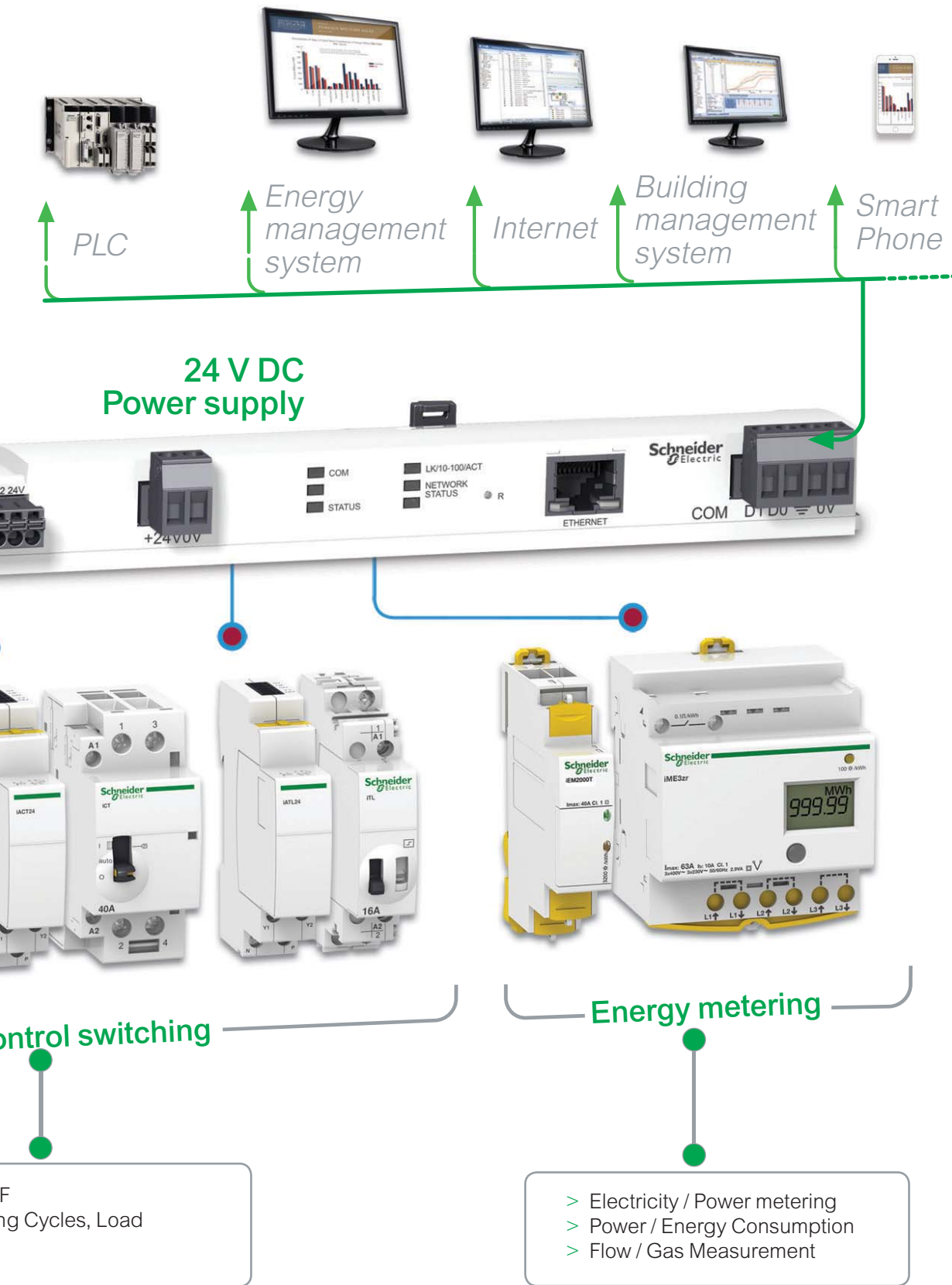

## Green Premium Products

100% Recyclable and Recoverable  
REACH, RoHS, PEP, EOL compliant

### AC Miniature Circuit Breakers - xC60



Green Premium

- Breaking Capacity as per IEC 60898 and IS/IEC 60898-1, Icn = 10kA
- Breaking Capacity as per IEC 60947-2, Icn = 15kA, upto 40A
- Can be used for DC application upto 60V per pole
- Higher system performance with optimized cost: Cascading\*
- Increased System Continuity: Discrimination\*
- Higher Installation Life: Energy Limitation Class 3, Fast Closure Mechanism
- Ease, Speed and Flexibility of installation - Biconnect, Line-Load Reversible
- Field-fittable auxiliaries for advance protection and monitoring
- Positive Contact Indication for assurance of disconnection

[In] Rated Current (A)	1 Pole Reference	Unit MRP [₹]	2 Pole Reference	Unit MRP [₹]	3 Pole Reference	Unit MRP [₹]	4 Pole Reference	Unit MRP [₹]
Module Width**	1 mod		2 mod		3 mod		4 mod	
MOQ	12 Nos.		6 Nos.		4 Nos.		3 Nos.	
<b>B curve</b>								
6	A9N1P06B ✓	449	A9N2P06B ✓	1355	A9N3P06B ✓	2249	-	-
10	A9N1P10B ✓	449	A9N2P10B ✓	1355	A9N3P10B ✓	2249	-	-
16	A9N1P16B ✓	449	A9N2P16B ✓	1355	A9N3P16B ✓	2249	-	-
20	A9N1P20B ✓	449	A9N2P20B ✓	1355	-	-	-	-
25	A9N1P25B ✓	449	-	-	A9N3P25B ✓	2249	-	-
32	A9N1P32B ✓	449	-	-	A9N3P32B ✓	2249	A9N4P32B ✓	3030
40	A9N1P40B ✓	974	-	-	-	-	A9N4P40B ✓	4362
63	A9N1P63B ✓	988	-	-	A9N3P63B ✓	3454	A9N4P63B ✓	4402
<b>C curve</b>								
1	A9N1P01C ✓	688	A9N2P01C ✓	1877	A9N3P01C ✓	2962	A9N4P01C ✓	3728
2	A9N1P02C ✓	688	A9N2P02C ✓	1877	A9N3P02C ✓	2962	A9N4P02C ✓	3728
3	A9N1P03C ✓	688	A9N2P03C ✓	1877	A9N3P03C ✓	2962	-	-
4	A9N1P04C ✓	688	A9N2P04C ✓	1877	A9N3P04C ✓	2962	A9N4P04C ✓	3728
6	A9N1P06C ✓	415	A9N2P06C ✓	1355	A9N3P06C ✓	2249	A9N4P06C ✓	3030
10	A9N1P10C ✓	415	A9N2P10C ✓	1355	A9N3P10C ✓	2249	A9N4P10C ✓	3030
16	A9N1P16C ✓	415	A9N2P16C ✓	1355	A9N3P16C ✓	2249	A9N4P16C ✓	3030
20	A9N1P20C ✓	415	A9N2P20C ✓	1355	A9N3P20C ✓	2249	A9N4P20C ✓	3030
25	A9N1P25C ✓	415	A9N2P25C ✓	1355	A9N3P25C ✓	2249	A9N4P25C ✓	3030
32	A9N1P32C ✓	415	A9N2P32C ✓	1355	A9N3P32C ✓	2249	A9N4P32C ✓	3030
40	A9N1P40C ✓	974	A9N2P40C ✓	2182	A9N3P40C ✓	3425	A9N4P40C ✓	4275
50	A9N1P50C ✓	974	A9N2P50C ✓	2182	A9N3P50C ✓	3425	A9N4P50C ✓	4402
63	A9N1P63C ✓	988	A9N2P63C ✓	2201	A9N3P63C ✓	3538	A9N4P63C ✓	4585
<b>D curve</b>								
2	A9N1P02D ✓	695	A9N2P02D ✓	1897	-	-	-	-
3	A9N1P03D ✓	695	-	-	A9N3P03D ✓	3008	-	-
4	A9N1P04D ✓	695	A9N2P04D ✓	1897	A9N3P04D ✓	3008	-	-
6	A9N1P06D ✓	586	A9N2P06D ✓	1421	A9N3P06D ✓	2369	-	-
10	A9N1P10D ✓	586	A9N2P10D ✓	1421	A9N3P10D ✓	2369	-	-
16	A9N1P16D ✓	586	A9N2P16D ✓	1421	A9N3P16D ✓	2369	A9N4P16D ✓	3142
20	A9N1P20D ✓	586	A9N2P20D ✓	1421	A9N3P20D ✓	2369	A9N4P20D ✓	3142
25	A9N1P25D ✓	586	A9N2P25D ✓	1421	A9N3P25D ✓	2369	A9N4P25D ✓	3142
32	A9N1P32D ✓	586	A9N2P32D ✓	1421	A9N3P32D ✓	2369	A9N4P32D ✓	3142
40	A9N1P40D ✓	1052	A9N2P40D ✓	2306	A9N3P40D ✓	3628	A9N4P40D ✓	4550
50	-	-	-	-	A9N3P50D ✓	3628	-	-
63	A9N1P63D ✓	1065	A9N2P63D ✓	2334	A9N3P63D ✓	3661	A9N4P63D ✓	4597

**Note:** \* Please contact nearest Schneider Electric Sales Office or Customer Care Center for coordination chart  
\*\*18mm/module

Please contact Customer Care Center for Stockable and Non stockable status of references.

✓ NORMAL STOCK ITEMS

W.E.F. January 17<sup>th</sup>, 2024

### AC Miniature Circuit Breakers - C120



- Breaking capacity as per IEC 60898, Icn = 10kA/15kA
- Positive Contact Indication for assurance of disconnection
- Degree of pollution: 3 (suitable for industrial environment)
- Operating Temperature: -30 to 70°C
- Terminal connections: Flexible cables up to 35 sq.mm; Rigid cables up to 50 sq.mm

[In] Rated Current (A)	1 Pole Reference	Unit MRP [₹]	2 Pole Reference	Unit MRP [₹]	3 Pole Reference	Unit MRP [₹]	4 Pole Reference	Unit MRP [₹]
Module Width**	1.5 mod		3 mod		4.5 mod		6 mod	
MOQ	12 Nos.		6 Nos.		4 Nos.		3 Nos.	
<b>C120N (10kA)</b>								
80	A9N18357 ✓	3787	A9N18361 ✓	8393	A9N18365 ✓	13184	A9N18372 ✓	17181
100	A9N18358 ✓	4248	A9N18362 ✓	8952	A9N18367 ✓	14051	A9N18374 ✓	17901
125	A9N18359 ✓	4675	A9N18363 ✓	9840	A9N18369 ✓	15585	A9N18376 ✓	20260
<b>C120H (15kA)</b>								
80	A9N18446	4359	A9N18457	10100	A9N18468	15494	A9N18479	21498
100	A9N18447	4997	A9N18458	10561	A9N18469	16880	A9N18480	23835
125	A9N18448	5517	A9N18459	11982	A9N18470	18216	A9N18481	25179

### DC Miniature Circuit Breakers - C60H



- Specially designed MCB for enhanced protection in DC installation
- Magnetic Arc Chutes to quick break DC current in event of fault
- Breaking capacity 6kA as per IEC 60947-2
- Voltage Rating: 1P - 250 V DC & 2P - 500 V DC
- Impulse Voltage: 6 kV
- Higher Installation Life: Energy Limiting Class: 3

[In] Rated Current (A)	Module Width 18mm/ module	1 Pole Reference	Unit MRP [₹]	Module Width 18mm/ module	2 Pole Reference	Unit MRP [₹]
MOQ		12 Nos.			6 Nos.	
<b>C60H-DC</b>						
0.5	1	A9N61500	1784	2	A9N61520	3917
1	1	A9N61501 ✓	1301	2	A9N61521 ✓	2685
2	1	A9N61502 ✓	1301	2	A9N61522 ✓	2685
3	1	A9N61503 ✓	1301	2	A9N61523 ✓	2685
4	1	A9N61504 ✓	1301	2	A9N61524 ✓	2685
5	1	A9N61505	1301	2	A9N61525	2685
6	1	A9N61506 ✓	1069	2	A9N61526 ✓	2185
10	1	A9N61508 ✓	1069	2	A9N61528 ✓	2185
16	1	A9N61511 ✓	1069	2	A9N61531 ✓	2185
20	1	A9N61512 ✓	1069	2	A9N61532 ✓	2185
25	1	A9N61513 ✓	1069	2	A9N61533 ✓	2185
32	1	A9N61515 ✓	1231	2	A9N61535 ✓	2185
40	1	A9N61517 ✓	1465	2	A9N61537 ✓	3222
50	1	A9N61518 ✓	1465	2	A9N61538 ✓	3222
63	1	A9N61519 ✓	1465	2	A9N61539 ✓	3222

### Special application MCBs



#### Solar Application – PV DC

- DC MCB for multi string PV installations
- Operating Voltage: 800V DC
- Current Rating up to 25A
- Complies to IEC / EN 60947-2



#### Rail Application\* (Including Rolling Stock)

- Fire & smoke Resis tant – Level 2 (NF F 16-101, NF F 16-102)
- Shock & vibration resistant (IEC 61373) – Cat 1, Class B
- Breaking Capacity: up to 25kA
- Complies to IEC / EN 60947-2



#### UL MCB

- Type: UL1077, UL489
- Breaking Capacity of 10kA
- Complies to IEC 60947-2 / UL1077 / UL489 / CSA

#### Note:

Please contact nearest Schneider Electric sales office or Customer Care for Reference and prices of Application Specific MCBs

\*Rail Application RCDs are also available on demand \*\*18mm/module

Please contact Customer Care Center for Stockable and Non stockable status of references.

✓ NORMAL STOCK ITEMS

W.E.F. January 17<sup>th</sup>, 2024



# Residual Current Devices (RCDs) - For Human and Fire Protection



**30  
mA**

Use of **30mA RCDs** is now **mandatory** for all **domestic intallations** in India {CEA Amendment regulation 2015\*}



**Schneider Electric provides voltage independent RCDs** which work on current sensing technology and provide protection from residual current even at extra low voltages (down to zero volts) and in case of break of neutral.

**SI  
Type**

**Schneider Electric offers SI RCD built to operate in electrically polluted or installation in aggressive environments:**

- Flourescent / Variable lighting with Electronic ballast
- Powerful IT / Telecom equipment / Air conditioning
- Severe Atmosphere - High lighting risk / Swimming pools

\* for Measures relating to Safety and Electric supply

Please contact Customer Care Center for Stockable and Non stockable status of references.

**NORMAL STOCK ITEMS**

W.E.F. January 17<sup>th</sup>, 2024

## AC Residual Current Circuit Breakers - xID



Suitable for  
ComReady  
Auxiliary



[In] Rated Current (A)	Earth-Leakage Sensitivity (mA)	Module Width 18mm/module	2 Pole Reference	Unit MRP [₹]	Module Width 18mm/module	4 Pole Reference	Unit MRP [₹]
25	30	2	A9N16201	4606	4	A9N16251	6465
	100	2	A9N16203	5112	4	A9N16253	6870
	300	2	A9N16202	5267	4	A9N16252	7072
40	30	2	A9N16204	5421	4	A9N16254	6364
	100	2	A9N16205	5845	4	A9N16255	6908
	300	2	A9N16206	6130	4	A9N16256	7175
63	30	2	A9N16208	6528	4	A9N16258	7369
	100	2	A9N16209	7021	4	A9N16259	8162
	300	2	A9N16210	7162	4	A9N16260	8200
80	30	2	A9N16212	10975	4	A9N16261	12999
	100	2	A9N16213	11157	4	A9N16262	13208
	300	2	-	-	4	A9N16263	13279

## AC Residual Current Circuit Breakers (RCCBs) - ID



- Complies to standards IEC 61008-1 and VDE 0664
- AC Class protection
- Degree of pollution: 3 (suitable for industrial environment)
- Electrical ON/OFF indication by using OFSP auxiliary

Poles Description	[In] Rated Current (A)	Earth-Leakage Sensitivity (mA)	Module Width 18mm/module	Reference	Unit MRP [₹]
4P	100	30	4	**A9R11491	-
		100	4	**A9R12491	-
	125	30	4	16905	55307
		100	4	16906	53849
		300	4	16907	54100

Note: \*\*For 100A RCCB Auxiliary kindly contact Customer Care

## AC Residual Current Breaker Overload (RCBO) - DPN N Vigi



Suitable for  
ComReady  
Auxiliary



- Complies to standards IEC/EN 61009
- AC Class Protection; Tripping characteristics - C curve
- Overvoltage category (IEC 60364): IV
- Suitable for indication & tripping auxiliaries

Poles Description	[In] Rated Current (A)	Earth-Leakage Sensitivity (mA)	Module Width 18mm/module	Reference	Unit MRP [₹]
1P+N	6	30	2	A9N19661	7314
		300	2	A9N19681	7429
	10	30	2	A9N19663	7314
		300	2	A9N19683	7429
	16	30	2	A9N19665	7314
		300	2	A9N19685	7429
	20	30	2	A9N19666	7314
		300	2	A9N19686	7429
	25	30	2	A9N19667	7314
		300	2	A9N19687	7429
	32	30	2	A9N19668	7314
		300	2	A9N19688	7799
	40	30	2	A9N19669	9254
		300	2	A9N19689	9415

Note: Application specific RCDs also available with 10mA, 500mA and 1000mA sensitivities | Please contact nearest Schneider Electric Sales Office or Customer Care Center for Reference and Prices

Please contact Customer Care Center for Stockable and Non stockable status of references.

✓ NORMAL STOCK ITEMS

W.E.F. January 17<sup>th</sup>, 2024

### SI Type Residual Current Circuit Breakers (RCCBs) - xID SI



- Complies to standard IEC/EN 61008-1
- SI RCDs offer enhanced immunity against Electrical Disturbances; Polluted and Corrosive environments - Guaranteed performance in harsh operating conditions
- Ensures continuity of supply in networks with:
  - Transient overvoltages
  - Loads generating HF leakage current i.e. harmonics
  - Loads generating continuous leakage current
- Ensures tripping on genuine earth fault in networks with:
  - Pulsating DC components
  - HF applications which "Blinds" (non-tripping) the conventional RCDs

[In] Rated Current (A)	Earth-Leakage Sensitivity (mA)	Module Width 18mm/module	2 Pole Reference	Unit MRP [₹]	Module Width 18mm/module	4 Pole Reference	Unit MRP [₹]
25	30	2	A9N16234	10715	4	A9N16321	11941
40	30	2	A9N16237	11254	4	A9N16324	12318
63	30	2	A9N16240	11578	4	A9N16327	12648
63	300	2	A9N16246	11664	4	-	-

### Vigi Block for xC60 (Add-on RCD Module, 2 & 4 Pole)



- Flexibility to use MCB of any tripping curve to suit applications, ensuring best 3 in 1 protection
- No auxiliary supply required
- AC Class protection
- Degree of pollution: 3 (suitable for industrial environment)
- Immune to nuisance tripping due to transient over voltages

[In] Rated Current (A)	Earth-Leakage Sensitivity (mA)	Module Width 18mm/module	2 Pole Reference	Unit MRP [₹]	Module Width 18mm/module	4 Pole Reference	Unit MRP [₹]
25	30	1.5	A9N26581	8253	3	A9N26595	9459
	100	1.5	A9N26582	9638	3	A9N26596	9813
	300	1.5	A9N26583	10191	3	A9N26597	10561
63	30	2	A9N26611	10595	3.5	A9N26643	10635
	100	2	A9N26612	11220	3.5	A9N26644	11045
	300	2	-	-	3.5	A9N26645	11556

**Note:** Vigi Block for High Rating up to 125A (C120) and High Breaking Capacity (NG125) available on demand

### SI Type Residual Current Breaker Overload ( RCBO) - DPN N Vigi SI



- Complies to standard IEC/EN 61009
- Ensures continuity of supply in networks with:
  - Transient overvoltages
  - Loads generating HF leakage current i.e. harmonics
  - Loads generating continuous leakage current
- Ensures tripping on genuine earth fault in networks with :
  - Pulsating DC components
  - HF applications which "Blinds" (non-tripping) the conventional RCDs

Poles Description	[In] Rated Current (A)	Earth-Leakage Sensitivity (mA)	Module Width 18mm/module	Reference	Unit MRP [₹]
1P+N	6	30	2	A9N19631	14561
		300	2	-	-
	10	30	2	A9N19632	14561
		300	2	-	-
	16	30	2	A9N19634	14561
		300	2	A9N19644	14561
	25	30	2	A9N19636	14561
		300	2	-	-
	32	30	2	A9N19637	14561
		300	2	-	-
	40	30	2	A9N19638	17241
		300	2	A9N19648	19186

\*For Prices, please contact nearest Schneider Electric Sales Office or Customer Care Center are Center for Reference and Prices

\*For prices, Please contact nearest Schneider Electric Sales Office or Customer Care Center and prices.

Please contact Customer Care Center for Stockable and Non stockable status of references.

NORMAL STOCK ITEMS

W.E.F. January 17<sup>th</sup>, 2024

### Common Auxiliaries for xC60 / C120 / RCDs Range

- Field-fittable auxiliaries (clip fitted) mounted on left side with maximum width of 54mm
- Order: Tripping Auxiliaries (MN first) followed by Indication Auxiliaries (SD first)

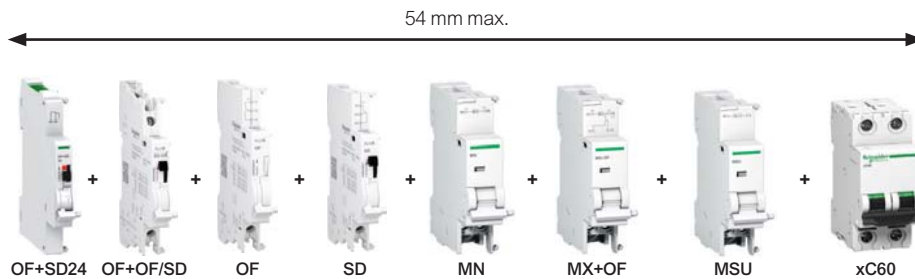

Type	Module Width 18mm/module	Reference	Unit MRP [₹]
<b>Indication Auxiliaries</b>			
Acti9 A9A iOF bottom wiring 0.1-6A aux	0.5	A9N26904	1413
Acti9 A9N SD bottom wiring 0.1-6A aux	0.5	A9N26907	1730
Acti9 A9N OF/SD+OF top/bt wir 0.1-6A aux	0.5	A9N26909	4407
Acti9 A9A iOF bottom wiring 0.1-6A aux	0.5	A9A26904	1447
Acti9 A9A iOF/SD+OF t&b wire 0.1-6A aux	0.5	A9A26909	4682
OF+SD24 auxiliary contact (ComReady)	0.5	A9N26899	3879
<b>Protection Auxiliaries – Trip Indication on front face</b>			
MN Under-voltage Release 220-240V AC	1	A9N26960	6232
MSU Over-voltage Release 275V AC	1	A9N26500	7380
<b>Tripping Auxiliaries – Trip Indication on front face</b>			
MX + OF Shunt Release 110-415V AC: for Remote tripping of Circuit Breaker	1	A9N26946	4054
MX + OF Shunt Release 12-24V AC/DC: for Remote tripping of Circuit Breaker	1	A9N26948	4054
<b>Auxiliary Switch for RCCBs – Mandatory for use of Auxiliaries with RCCBs</b>			
Auxiliary switch for RCCB up to 80A (OF-S)	0.5	A9N26923	5936
Auxiliary switch for RCCBs 125A (OFSP)	0.5	16940	2924

### Accessories



Type	Description	Reference	Unit MRP [₹]
Rotary Handle*	Breaker Switching Sub-Assembly	27046	6714
Rotary Handle*	Extended, Disconnectable handle	27047	3390
Padlock** (bag of 2)		26970	1319
Multicable terminal for 3 copper cables**		19096	10913
Aluminum cable terminal**		27060	790
Spacer		A9N27062	333

\* for xC60, C120, DPN N Vigi, C60H-DC, xSW - Multi poles only

\*\*for xC60, xID, DPN N Vigi, C60H-DC, xSW, C60PV-DC

**Note:** For all above Reference MOQ = 1

Please contact Customer Care Center for Stockable and Non stockable status of references.

NORMAL STOCK ITEMS

W.E.F. January 17<sup>th</sup>, 2024

# Protection Against Lightning Strikes And Switching Surges



For all low voltage switchboards and electrical enclosures:

## Comprehensive range

- To ensure the protection of equipment connected to:
- Low voltage networks,
- Telecommunications networks,
- Computer networks.
- Easy to implement and use.
- Compatibility with all earthing systems (TT, TNS, TNC, IT).
- Technical and aesthetic consistency

## Continuity of service and certified safety

Schneider Electric certified coordination between the surge arrester and its disconnection circuit breaker.

Compliance with standards: IEC/EN 61643-11.



More and more electrical equipment today is sensitive to overvoltages caused by lightning.



# 90%

of power outlets supply equipment incorporating electronic devices.



iQuick PRD “built-in” technology surge arresters, a Schneider Electric innovation, incorporate their own disconnection circuit breaker: easy to choose and simple to install for greater effectiveness.



Up to **30%** of installation time saved.

Please contact Customer Care Center for Stockable and Non stockable status of references.

NORMAL STOCK ITEMS

W.E.F. January 17<sup>th</sup>, 2024

### Surge Arresters - Type 1+ 2



- Complies to IEC 61643-1 and EN 61643-11
- Withdrawable type: Easy Replacement
- Inbuilt SPD health Indicator: Also available with remote signaling
- For protection against Direct lightning surge, Indirect lightning surge, Switching surge
- Imp up to 25kA & I<sub>max</sub> upto 40kA
- **Always use a Back-up MCB with your SPD**
- Maximum Operating Voltage [U<sub>c</sub>]: 350V

Type	Pole Description	Module Width 18mm/module	Reference	Unit MRP [₹]
PRD1 25r	1P	2	16329	23208
	1P + N	4	16330	41658
	3P	6	16331	65595
	3P + N	8	16332	81499

### Surge Arresters iPRD - Type 2 (Withdrawable type) (TT, TN-S, TN-C Systems)



- In conformance with standards IEC 61643-11/2011 T2 and EN 61643-11 Type 2
- For protection against Indirect lightning surge and Switching surge
- Inbuilt health Indicator
- Response time < 25ns
- I<sub>max</sub> (8/20 s): 65/40/15/8kA
- Maximum Operating Voltage [U<sub>c</sub>]: 340V
- Level of protection, U<sub>p</sub>: 1.0 - 2.0 kV
- Remote indication contact with 8r/20r/40r/65r
- **Always use a Back-up MCB with your SPD**

Type	Rated Voltage (V)	Pole Description	Module Width 18mm/module	Reference	Unit MRP [₹]
iPRD8	230	1P	1	A9L08100	5685
	230	1P+N	2	A9L08500	10844
	230/400	3P	3	A9L08300	14636
	230/400	3P+N	4	A9L08600	22092
iPRD8r	230	1P+N	2	A9L08501	13000
	230/400	3P+N	4	A9L08601	26511
iPRD20	230	1P	1	A9L20100	6372
	230	1P+N	2	A9L20500	13632
	230/400	3P	3	A9L20300	17450
iPRD20r	230/400	3P+N	4	A9L20600	24671
	230	1P+N	2	A9L20501	15894
	230/400	3P+N	4	A9L20601	30167
iPRD40	230	1P	1	A9L40100	7911
	230	1P+N	2	A9L40500	15700
	230/400	3P	3	A9L40300	22536
iPRD40r	230/400	3P+N	4	A9L40600	31425
	230	1P	1	A9L40101	8857
	230	1P+N	2	A9L40501	20240
iPRD65r	230/400	3P	3	A9L40301	30328
	230/400	3P+N	4	A9L40601	37717
	230	1P	1	A9L65101	11841
iPRD65r	230	1P+N	2	A9L65501	25796
	230/400	3P	3	A9L65301	33662
	230/400	3P+N	4	A9L65601	43678

### Spare Cartridges for iPRD



- Spare Cartridges for iPRD8r, iPRD20r, iPRD40r and iPRD65r
- End of life indication available on front face
- These Cartridges are not compatible with Old SPD range (A9L16...)\*\*

Type	Spare Cartridges for	Reference	Unit MRP [₹]
iPRD 65-350	iPRD65r	A9L65102	7561
iPRD 40-350	iPRD40, iPRD40r	A9L40102	6108
iPRD 20-350	iPRD20, iPRD20r	A9L20102	4662
iPRD Neutral	All products (1P+N, 3P+N)	A9L00002	6243

\*\*Spare Cartridges for Old SPD Range (A9L16...) are available on demand - please contact nearest Schneider Electric Sales Office or Customer Care for Reference and prices

**Note:** For all above Reference MOQ = 1

Please contact Customer Care Center for Stockable and Non stockable status of references.

NORMAL STOCK ITEMS

W.E.F. January 17<sup>th</sup>, 2024

### iQuick PRD - Type 2 with inbuilt MCB



- Compact SPD with in-built back up MCB - saving on space, MCB selection, wiring time
- Compliance to EN 61643-11
- Withdrawable Type - Cost Efficient - Allows damaged Cartridges to be replaced without having to replace entire SPD
- Inbuilt SPD Health Indicator on front face of device; Remote signaling functionality also available
- Incoming Protection: iQuick PRD 40r (High Risk level) and iQuick PRD 20r (Moderate Risk level)
- Secondary Protection: iQuick PRD 8r is cascade mounted with incoming surge arresters

Type	Pole Description	Module Width 18mm/module	Reference	Unit MRP [₹]
iQuick PRD 8r	1P+N	4	A9L16298	16330
	3P	6.5	A9L16299	24488
	3P+N	7.5	A9L16300	30471
iQuick PRD 20r	1P+N	4	A9L16295	18670
	3P	6.5	A9L16296	29397
	3P+N	7.5	A9L16297	36566
Quick PRD 40r	1P+N	4	A9L16292	23352
	3P	6.5	A9L16293	34985
	3P+N	7.5	A9L16294	43478

**Note:** Spare / Replacement Cartridges available - For Reference and prices contact nearest sales office or customer care

### Photovoltaic Surge Arresters



- Protection for photovoltaic panels and the DC input to the inverter from overvoltages due to a lightning strike
- Type 2 surge arresters
- Should be installed in switchboard inside the building. If switchboard is located outside, it must be weatherproof
- Withdrawable surge arrester allows damaged Cartridges to be replaced quickly
- Inbuilt SPD Health Indicator on front face of device; Remote signaling functionality also available

Type	U (cpv) Maximum Operating Voltage (V)	Module Width 18mm/module	Reference	Unit MRP [₹]
iPRD 40r	800	3	A9L40271	12416
	1000	3	A9L40281	15198

**Note:** Spare / Replacement Cartridges available - For Reference and prices contact nearest sales office or customer care

### Surge Arresters for Communication Networks



- Analogue telephone line protection: iPRC surge arrester wired in series to the private installation input, protects the telephones, the modems (including ADSL) etc
- Protection for 2 low-current lines without common potential or 4 lines with common reference potential
- iPRI protects measuring instrument and PLC sensor inputs and the DC power supply inputs up to 53 V and AC power supply inputs up to 37 V

Type	[Ue] Operational Voltage (V)	Module Width 18mm/module	Reference	Unit MRP [₹]
PRI	48 V DC	1	A9L16339	22589
PRC	130 V AC	1	A9L16337	13543

**Note:** For all above Reference MOQ = 1

### Isolator - xSW



- Complies to IEC/EN 60947-3
- Switching duty: AC-22
- Impulse voltage: 6kV
- DC application: 48V (110V with 2 poles in series)
- Short circuit withstand 20 In for 1 second
- Upto 80A Bi connect terminals & 100A to 125A with mono connect terminals

Poles Description	[In] Rated Current (A)	Module Width 18mm/module	MOQ	Reference	Unit MRP [₹]
2	40	2	6	A9S2P040	906
	63	2	6	A9S2P063	1197
3	40	3	4	A9S3P040	1583
	63	3	4	A9S3P063	1854
4	40	4	3	A9S4P040	2004
	63	4	3	A9S4P063	2182
	80	4	3	A9S4P080	2702
	100	4	3	A9S4P100	3650
	125	4	3	A9S4P125	4034

### Selector Switch - iSSW



- Complies to IEC 60947-5-1 and IEC 60669-1
- Rating 20A, 250V AC
- Electrical life (AC22): 30,000 cycles
- Connection: tunnel terminals cables up to 10 sq. mm

No. of positions	Poles Description	Contacts	Module Width 18mm/module	MOQ	Reference	Unit MRP [₹]
2	1	1 C/O	1	12	A9E18070	1938
	2	2 C/O	2	6	A9E18071	2665
	2	1NO + 1NC	1	12	A9E18072	1553
3	1	1 C/O	1	12	A9E18073	1779
	2	2 C/O	2	6	A9E18074	3215

### iRO Buzzers



- Audible indication in housing and the tertiary sector
- Sound level of 70dBA at a distance of 60cm

Voltage	Module Width 18mm/module	Reference	Unit MRP [₹]
230V AC	1	A9A15322	2407

Please contact Customer Care Center for Stockable and Non stockable status of references.

NORMAL STOCK ITEMS

W.E.F. January 17<sup>th</sup>, 2024



### iCT Contactors



- Complies with standards IEC 1095, E N 61095
- 4 operating modes switch on front face :
  - Automatic mode
  - Temporary "ON" mode
  - Permanent "ON" mode
  - Shutdown
- Mechanical contact position Indicator
- Safe installation maintenance: lock the contactor in ON position
- Silent operation (20dB) for entire range

Type	Rating (A)	No. of Contacts	Module Width 18mm/module	Reference	Unit MRP [₹]
1P	25	1NO	1	A9C20731	2856
	16	2NO	1	A9C22712	2940
2P	25	2NO	1	A9C20732	3515
	40	2NO	2	A9C20842	7163
	63	2NO	2	A9C20862	7683
3P	25	3NO	2	A9C20833	4529
	40	3NO	2	A9C20843	10055
	63	3NO	3	A9C20863	10927
4P	25	4NO	2	A9C20834	4743
	40	4NO	2	A9C20844	11711
	63	4NO	3	A9C20864	12355
	63	2NO + 2NC	3	A9C20868	13763

**Note:** 100A Contactor in 2P / 4P - available on request

### iTL Impulse Relays



- Complies with standards IEC/EN 60669-2-2
- Safe maintenance: disconnection of remote control by selector switch
- Manual Controls on front face: 0-I toggle
- Mechanical contact position Indicator
- Maximum 5 operations/min. and 100 switching operations/day
- Degree of pollution: 3 (suitable for industrial environment)

Type	Rating (A)	Control Voltage	No. of Contacts	Module Width	Reference	Unit MRP [₹]
1P	16	230-240 VAC	1NO	1	A9C30811	1852
	32	230-240 VAC	1NO	1	A9C30831	2331
2P	16	230-240 VAC	2NO	1	A9C30812	3037
	32	230-240 VAC	2NO	1	A9C30831 + A9C32836	6882
3P	16	230-240 VAC	1NO+1NO/NC+1NO	2	A9C30811 + A9C32816	5503
	32	230-240 VAC	1NO+1NO/NC+1NO	2	A9C30831 + 2 x A9C32836	11433
4P	16	230-240 VAC	4NO	2	A9C30814	5871
	32	230-240 VAC	4NO	2	A9C30831 + 3 x A9C32836	15984

### iIL Indicator Lights



- Complies with standard IEC 60947-5-1
- Indicator light with LED technology
- Service life 100,000 hours with constant luminous efficiency

Type	Colour	Module Width 18mm/module	Reference	Unit MRP [₹]
Single Indicator light	Red	1	A9E18320	1915
	Green	1	A9E18321	1915
	Blue	1	A9E18323	1915
	Orange	1	A9E18324	1915
3 phase voltage presence light	Red/Red/Red	1	A9E18327	5532
Single Push Button (1 NO+ 1NC)	Grey	1	A9E18033	2579

**Note:** For all above Reference MOQ = 1

Please contact Customer Care Center for Stockable and Non stockable status of references.

NORMAL STOCK ITEMS

W.E.F. January 17<sup>th</sup>, 2024

## Communication Auxiliaries



Auxiliary for Protection Devices (OF+SD24)      Auxiliary for Contactors (iACT24)      Auxiliary for Impulse Relays (iATL24)

Description	Module Width	Reference	Unit MRP [₹]
OF+SD24	0.5	A9N26899	3879
iACT24	1	A9C15924	17842
iATL24	1	A9C15424	18787

## Acti 9

Description	Reference	Pack	Unit MRP [₹]
<b>Distribloc 63A</b>			
Distribution from the top (4 Module)	04040	1	15571
Distribution through the bottom (4 Module)	04041	1	15571

## Reflex iC60 - Integrated Control & Overcurrent Protection Device



- All in One Solution: MCB + Contactor + Impulse Relay + Auxiliary
- 10kA Breaking capacity as per IEC/EN 60947-2,
- Ti24 interface: Connection to PLC, Smartlink
- 3 operating modes to cater to a variety of applications
- Safe lock down with Integrated Padlocking
- Simplified maintenance: Front face Indicator allows better reliability

[In] Rated Current (A)	2 Pole Reference	Unit MRP [₹]	3 Pole Reference	Unit MRP [₹]	4 Pole Reference	Unit MRP [₹]
Module Width **	4.5 mod		5.5 mod		6.5 mod	
<b>B Curve</b>						
10	A9C61210	49082	-	-	A9C61410	58849
16	A9C61216	49076	-	-	-	-
25	-	-	A9C61325	51257	-	-
40	-	-	A9C61340	54818	-	-
<b>C Curve</b>						
10	A9C62210	52114	A9C62310	52825	A9C62410	56074
16	A9C62216	52114	A9C62316	53887	A9C62416	56074
25	A9C62225	49626	A9C62325	52825	A9C62425	56074
40	A9C62240	52268	A9C62340	54844	A9C62440	61304
63	-	-	A9C62363	56954	A9C62463	62899
<b>D Curve</b>						
25	-	-	-	-	A9C63425	58327

Note: \*\*18mm/module

Please contact Customer Care Center for Stockable and Non stockable status of references.

NORMAL STOCK ITEMS

W.E.F. January 17<sup>th</sup>, 2024

# Isobar Distribution System

## EcoStruxure™ Innovation At Every Level

From sensors to services, our Innovation At Every Level approach improves energy and operational efficiency by tapping the true business value of IoT advancements. We've made mobility, sensing, cloud, analytics, and cyber security technologies meaningful to customers, helping them compete in our IoT economy.

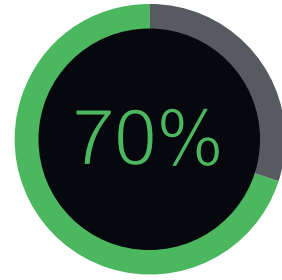

70%  
of decision-makers see the business value of IoT\*

\*Schneider Electric IoT 2020 Business Report

### Connected Products:

The Internet of Things starts with the best things. Our IoT-enabled best-in-class connected products include breakers, drives, UPSs, relays, sensors, and more. Devices with embedded intelligence drive better decision-making throughout operations.

### Edge Control:

Mission-critical scenarios can be unpredictable, so control of devices at the edge of the IoT network is a must. This essential capability provides real-time solutions that enable local control at the edge, protecting safety and uptime.

### Applications, Analytics, and Services:

Interoperability is imperative to supporting the diverse hardware and systems in building, data center, industry, and grid end markets. EcoStruxure™ enables a breadth of agnostic applications, analytics, and services for seamless enterprise integration.

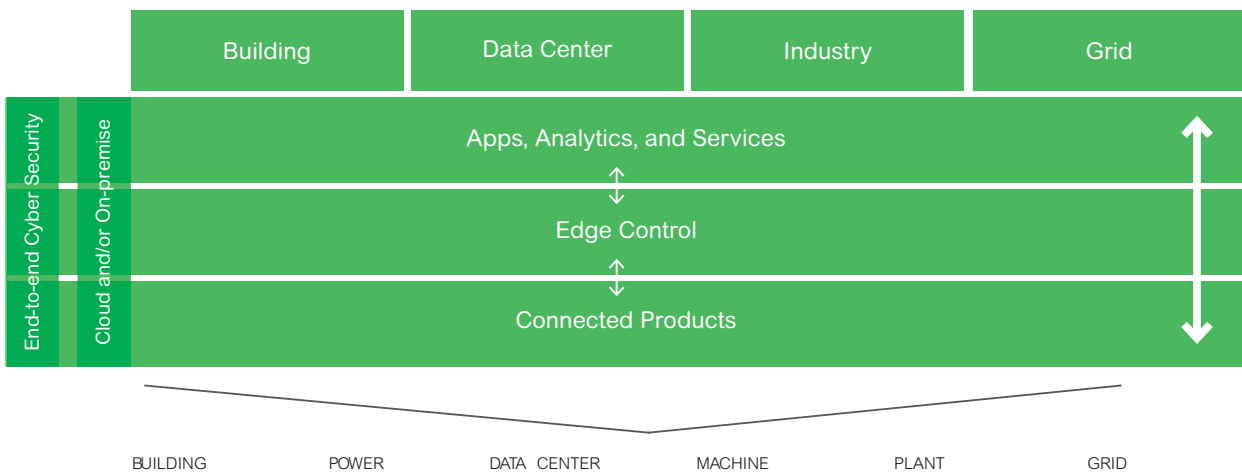

Please contact Customer Care Center for Stockable and Non stockable status of references.

NORMAL STOCK ITEMS

W.E.F. January 17<sup>th</sup>, 2024

# Connectivity built in

Acti9 Isobar harnesses the connectivity of the Acti9 range enabling distribution boards to become smart and connected.



1. Enable asset management on all outgoing ways with **PowerTag**



2. **Smartlink SiD** for wireless data concentration



3. Enable further asset and energy management through PowerTag for Compact NSX



4. Monitor and control your assets with SiB Smartlink



5. See the power and optimise the use of your assets with Facility Expert our simple on-line services platform

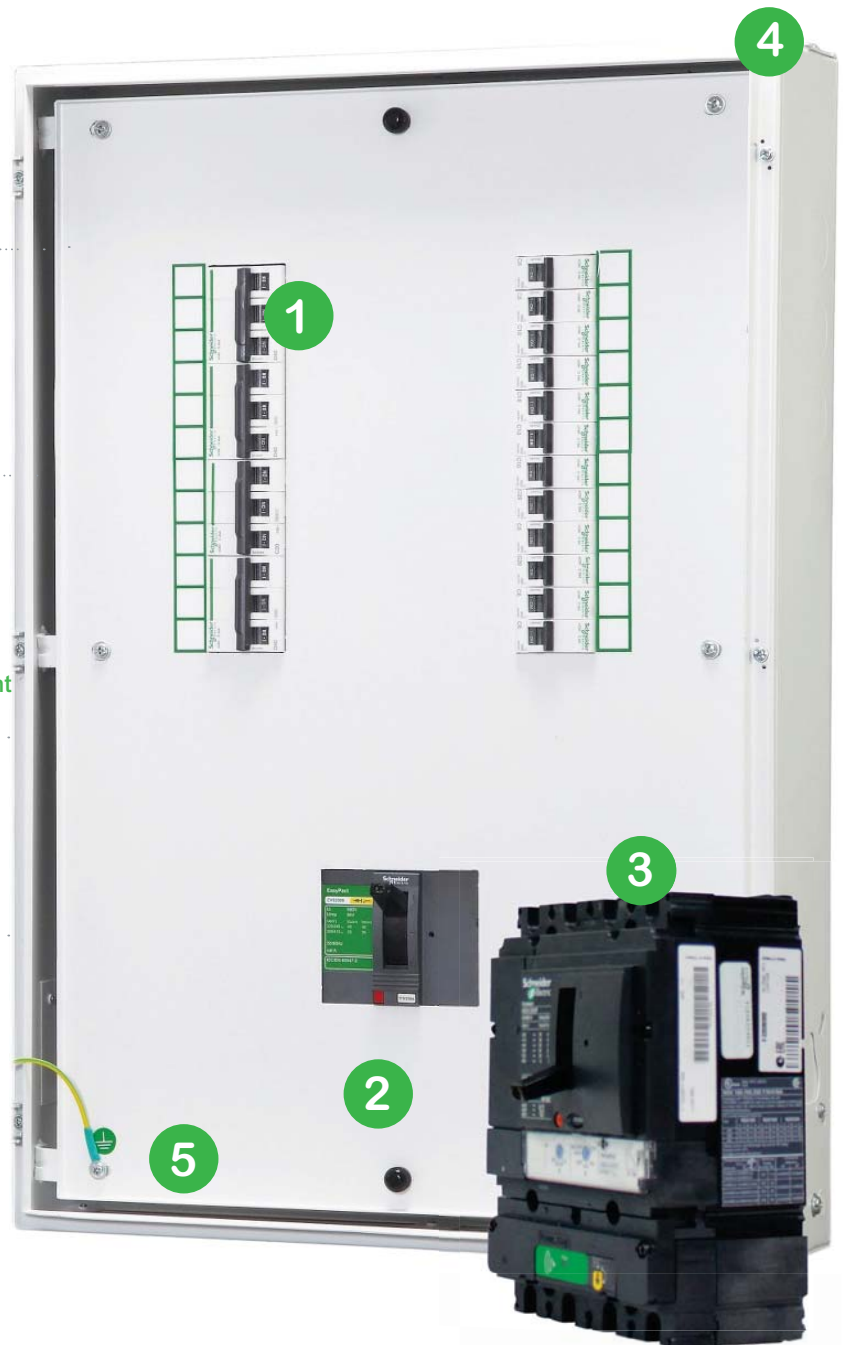

Please contact Customer Care Center for Stockable and Non stockable status of references.

NORMAL STOCK ITEMS

W.E.F. January 17<sup>th</sup>, 2024

# Acti 9

## Isobar Pan Assembly

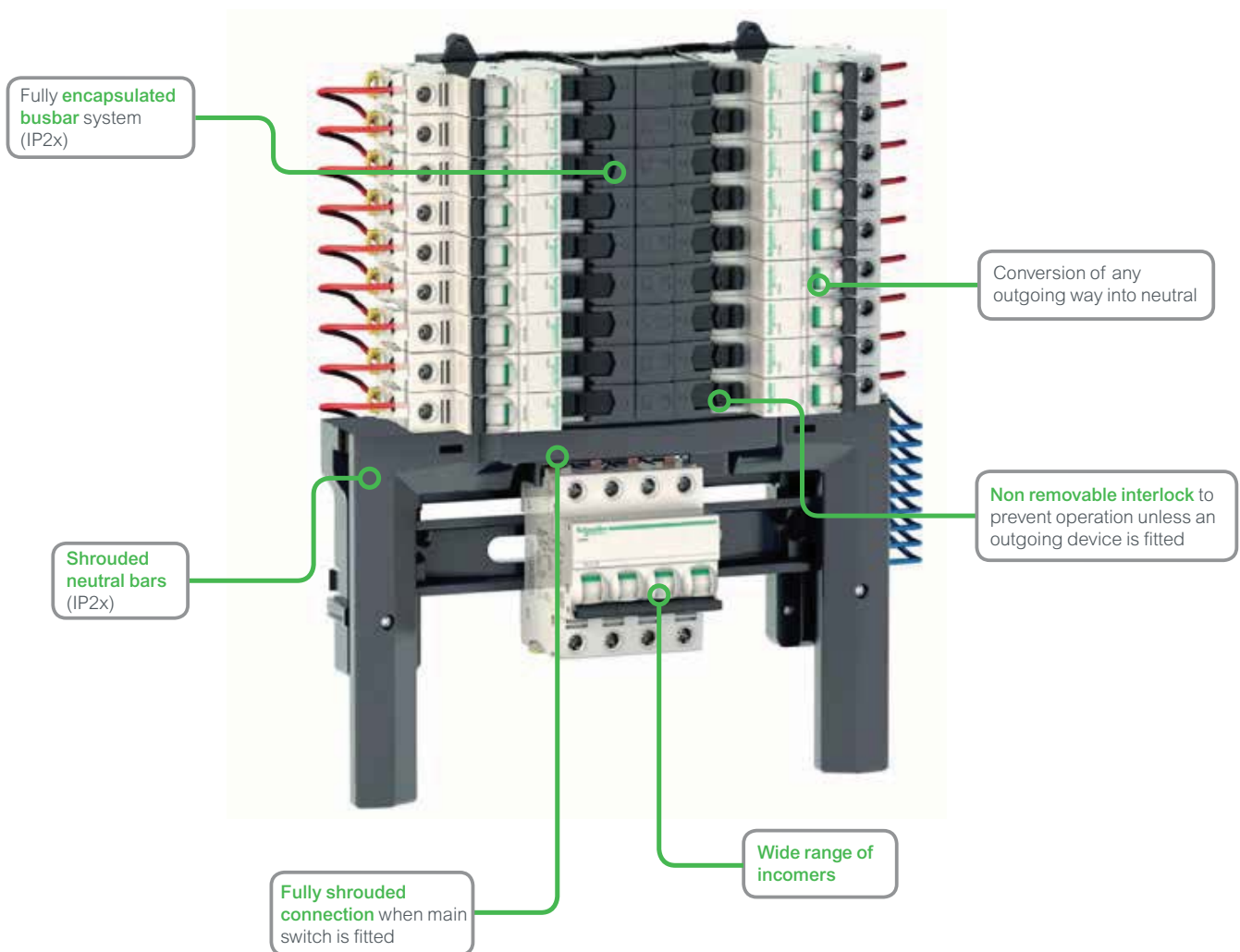

- Fully type tested conditional short circuit rating of 25kA to BS EN 61439-3
- High performance MCB 10kA BS EN 60898 15kA BS EN 60947-2 in B, C or D curve 1, 2, 3, 4 pole
- 250A busbar rating
- Isobar disconnection to BS EN 60947-3 ensuring unused outgoing ways are isolated
- Option of switching outgoing neutral on all boards using distributed neutral kit
- Range of incomers: switch disconnectors, residual current devices, terminal blocks, mccb
- Single pole RCBO for new or retrofit maintaining device density
- Full range of device accessories and auxiliaries
- Shrouded Neutral
- Convention of any outgoing way into Neutral

Description	Double Door Metal (IP43) Reference	Unit LP [₹]
Acti9 Isobar B - pan assembly - 16 ways TP + earth + neutral	SEA9BN16PEV	*
Acti9 Isobar B - pan assembly - 18 ways TP + earth + neutral	SEA9BN18PEV	*
Acti9 Isobar B - pan assembly - 24 ways TP + earth + neutral	SEA9BN24PEV	*
Acti 9 - 1P blank terminal block (no electrical connection)	SEA9BP	*
Isobar B - neutral bar - 1N - for distribution board - 16 ways	SEA9NB16	*
Isobar B - neutral bar - 1N - for distribution board - 18 ways	SEA9NB18	*
Isobar B - neutral bar - 1N - for distribution board - 24 ways	SEA9NB24	*
Isobar A - neutral bar - 1N - for distribution board - 4 ways SP+N	SEA9NKIT	*
Acti 9 - terminal block - 250A	SEA9NPB250TB	*
Acti 9 Isobar B - MCCB/Interpact connection kit	SEA9BINCKIT	*

**\* Price on Request**

Please contact Schneider Electric Customer Care Center for Prices

NORMAL STOCK ITEMS

W.E.F. January 17<sup>th</sup>, 2024

# Acti 9

## Distribution Boards

### Spectacular Design

*Blends seamlessly with interiors*



Unique Rounded Corners | Color - RAL 9003 white | Designer Rotary Knob

### Maximized Wiring Space

*Convenient and Safe wiring*

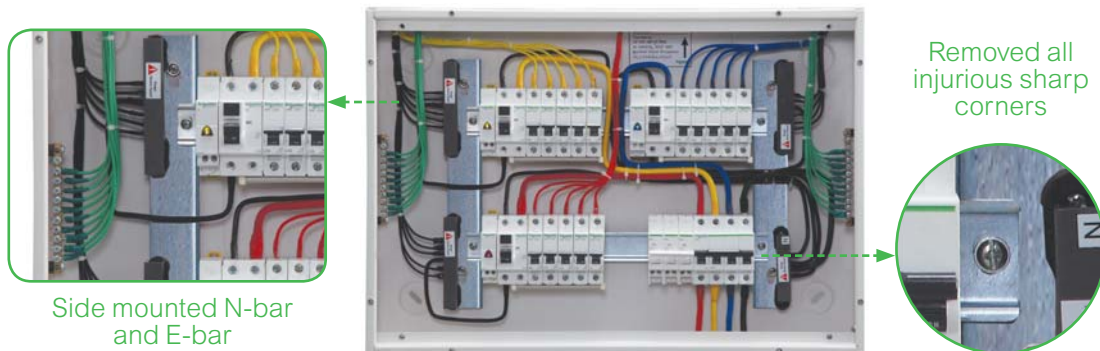

Side mounted N-bar and E-bar

Removed all injurious sharp corners

15% more wiring area | Reduced U-box Collar | Removable Frame, Centre plate & Gland plate

### Adaptable

*Total Flexibility for ease of installation and usage*



Unique 5 holes mounting with positioning hole

Surface and Flush installation | Field fittable key lock provision | Reversible Door

Inspiring the **S.M.A.R.T.** choice!!!

## Robust Architecture

*Perfect blend of Strength & Weight*



High Strength-to-Weight ratio | RoHS and REACH Compliance – ideal solution for GREEN Buildings

**NEW**

Base Material used - Galvanized Iron

## 4X Rust Resistance

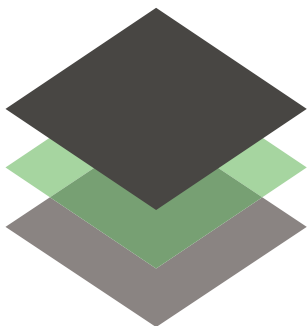

1. Powder Coating
- 2. Galvanized Iron**
3. Base Iron

**Galvanized Iron** | Gives 4X rust resistance  
**No Rusting** | Even if the powder coating is scratched  
**No Propagation Of Rust** | Even If base material is chipped off  
**No Hassle** | of repainting due to rusting

Inspiring the **S.M.A.R.T.** choice!!!

Technically Proven

Safety Guaranteed



Designed and Manufactured as per **IS 8623 - 1 & 3** | IP and IK test by ERDA & CPRI | Glow wire tested

Type Tested as per IEC 61439 - 1 & 3



IEC 61439 - 3\* Fully Compliant

\*Tested at **NABL** and **ASTA** accredited testing facility



Salt Spray



IP43



IK09



Reliable Door



Earthing



Temp@  
Max Curr

Mechanical Tests

Electrical Tests

Please contact Customer Care Center for Stockable and Non stockable status of references.

NORMAL STOCK ITEMS

W.E.F. January 17<sup>th</sup>, 2024



# Acti 9

## Distribution Boards

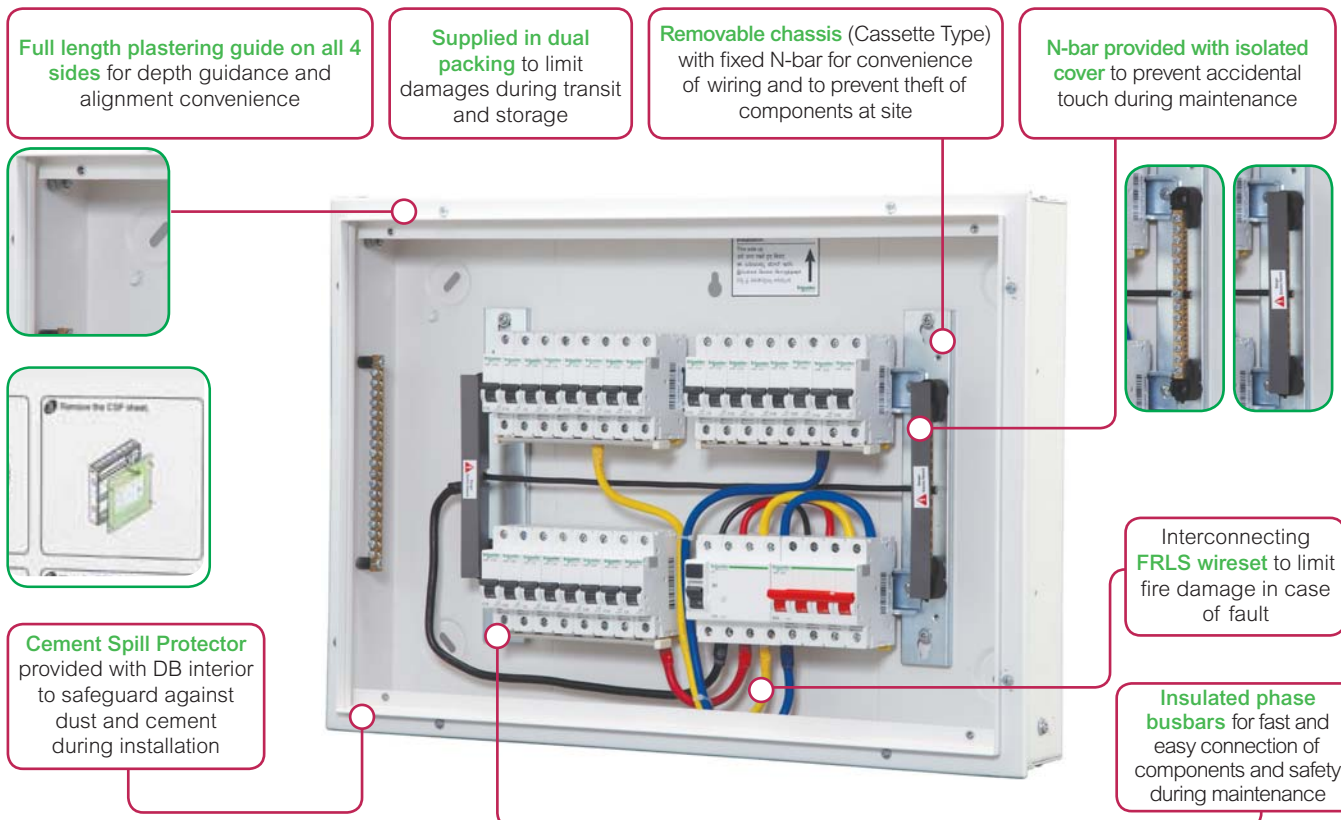
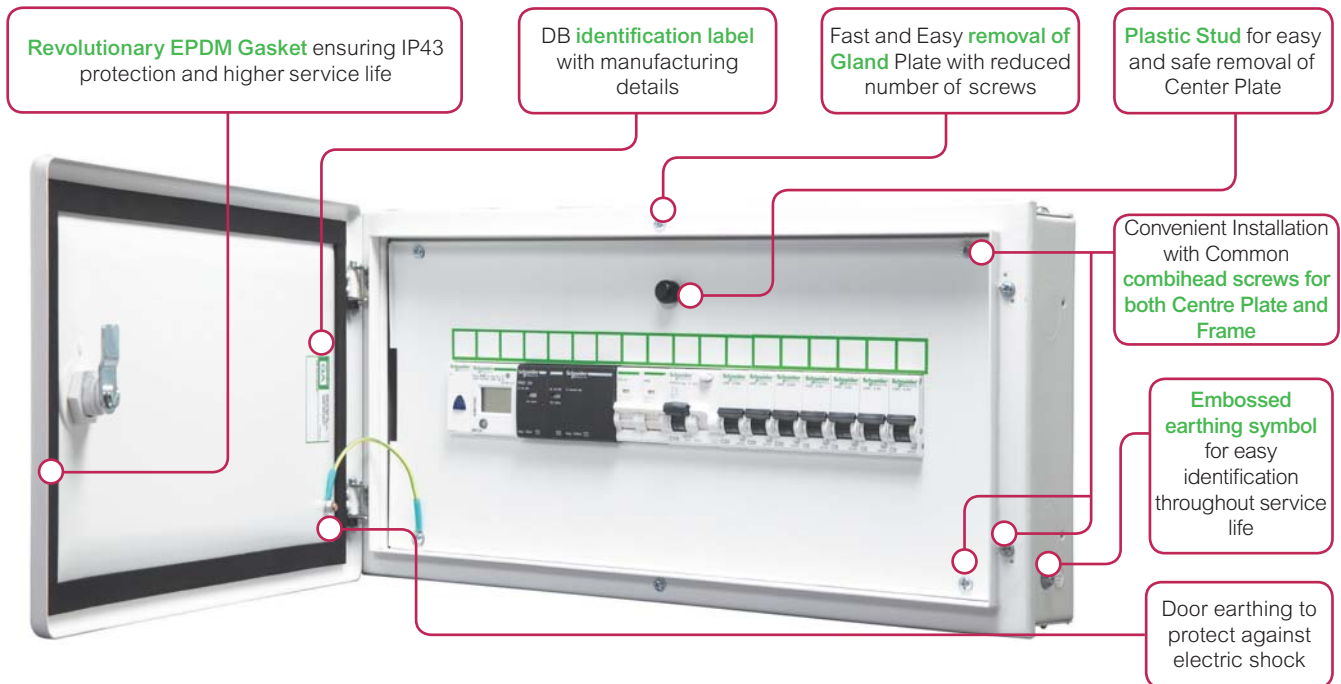

Please contact Customer Care Center for Stockable and Non stockable status of references.

**NORMAL STOCK ITEMS**

W.E.F. January 17<sup>th</sup>, 2024

### Metal Enclosures



- Metal Enclosure to mount individual Modular Device feeding directly to the load or final distribution board

Description	Total Module Cutout	Single Door (IP30) Reference	Unit MRP [₹]
2 way	1 / 2	A9HMES02 <input checked="" type="checkbox"/>	1055
4 way	3 / 4	A9HMES04 <input checked="" type="checkbox"/>	1055

### SPN DBs



- SPN DB for distribution of Single Phase Neutral supply to respective load MCBs
- Incomer - DP RCCB/RCBO/Isolator/MCB
- Outgoing - SP MCBs

Description	Total Module Cutout (Incomer + Outgoing)	Single Door (IP30) Reference	Unit MRP [₹]	Double Door Metal (IP43) Reference	Unit MRP [₹]
6 way	6	A9HSNS06	2043	A9HSND06 <input checked="" type="checkbox"/>	2935
8 way	8	A9HSNS08 <input checked="" type="checkbox"/>	2423	A9HSND08 <input checked="" type="checkbox"/>	3199
12 way	12	A9HSNS12	2867	A9HSND12 <input checked="" type="checkbox"/>	3847
18 way	18	-	-	A9HSND18 <input checked="" type="checkbox"/>	5154

### TPN DBs



- Standard TPN DBs for distribution of Three Phase and Neutral supply
- Incomer - FP RCCB/RCBO/Isolator/MCB
- Outgoing - SP MCBs

Description	Total Module Cutout (Incomer + Outgoing)	Single Door (IP30) Reference	Unit MRP [₹]	Double Door Metal (IP43) Reference	Unit MRP [₹]
4 way eco	4 + 12	-	-	A9HTND04E <input checked="" type="checkbox"/>	7657
4 way	8 + 12	-	-	A9HTND04 <input checked="" type="checkbox"/>	7723
6 way	8 + 18	-	-	A9HTND06 <input checked="" type="checkbox"/>	7838
8 way	8 + 24	-	-	A9HTND08 <input checked="" type="checkbox"/>	9665
12 way	8 + 36	-	-	A9HTND12 <input checked="" type="checkbox"/>	14756

### Flexi Tier DBs



- Flexi DBs give total flexibility to mount any type and size of Modular devices as per load requirement
- Provided with N-Bar and E-Bar
- Flexi Tier DBs can be converted to PPI DB using 'PPI Kit' provided on next page

Description	Total Module Cutout (Incomer + Outgoing)	Single Door (IP30) Reference	Unit MRP [₹]	Double Door Metal (IP43) Reference	Unit MRP [₹]
2 Tier 24 Modules	2 x 12	-	-	A9HFD224	8277
3 Tier 36 Modules	3 x 12	-	-	A9HFD336	9941
4 Tier 40 Modules	4 x 10	-	-	A9HFD440 <input checked="" type="checkbox"/>	10501
4 Tier 56 Modules	4 x 14	-	-	A9HFD456 <input checked="" type="checkbox"/>	10976

**Note:** For all above Reference MOQ = 1

Please contact Customer Care Center for Stockable and Non stockable status of references.

NORMAL STOCK ITEMS

W.E.F. January 17<sup>th</sup>, 2024

# Acti 9

## Distribution Boards

### New Phase Segregated DBs

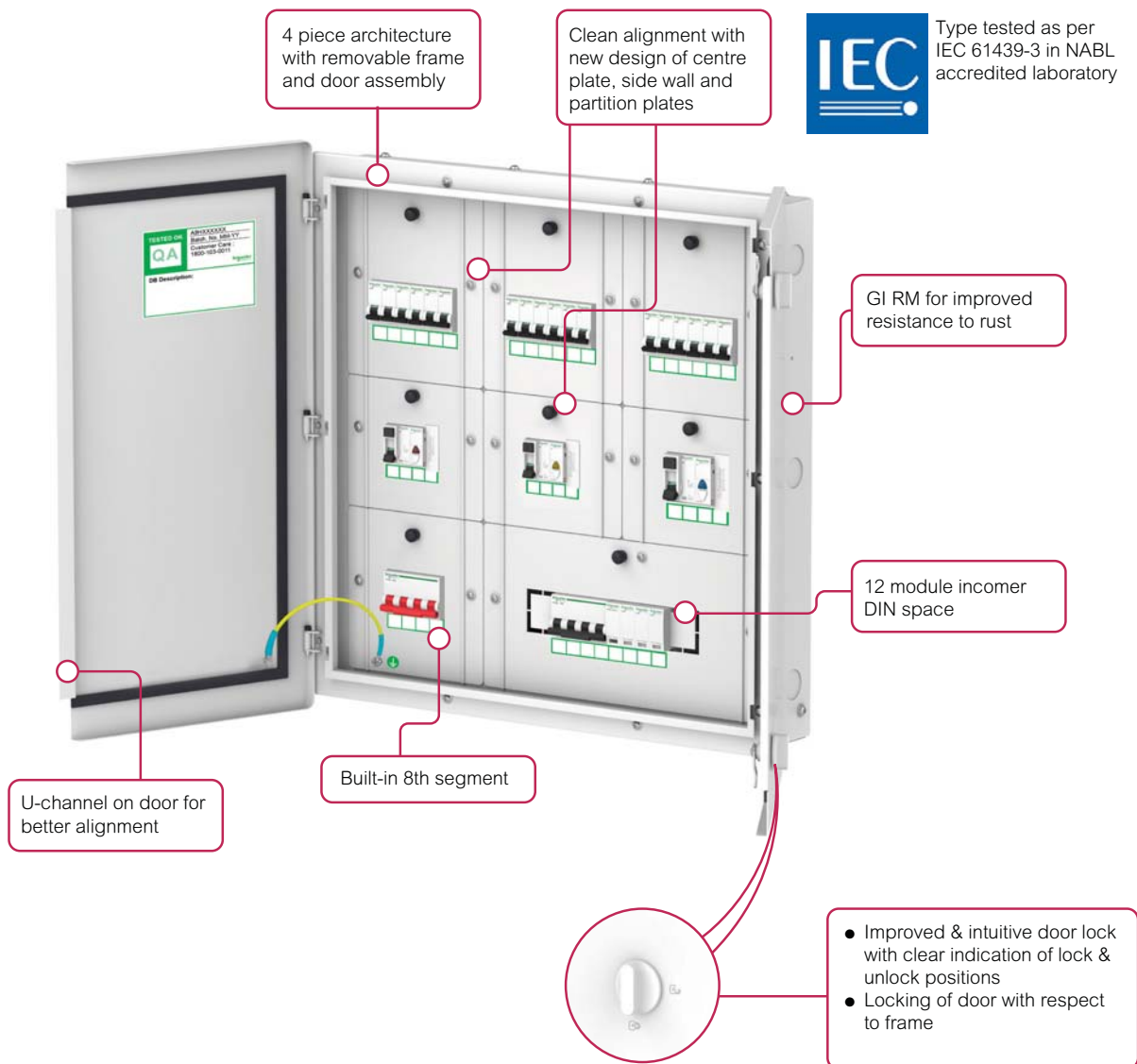

### Key highlights

- 1 New compact design
- 2 Robust architecture
- 3 Type-tested system
- 4 4 piece construction
- 5 Built-in 8th segment
- 6 Split door for all variants
- 7 Clean alignment of doors, centerplates
- 8 Improved door locking
- 9 High rust resistance with GI
- 10 Increased incomer DIN space

Please Contact nearest Schneider Electric Sales Office and Customer Care Center for your reference.

Please contact Customer Care Center for Stockable and Non stockable status of references.

☑ NORMAL STOCK ITEMS

W.E.F. January 17<sup>th</sup>, 2024

### Per Phase Isolation DBs

- PPI DBs to mount DP Residual Current Device (RCD) at an individual phase level to isolate the faulty phase in case of earth leakage and ensure continuity of supply to other healthy phases
- Incomer - Modular (FP MCB/Isolator) MCCB100A (TP/FP Compact NSX or EasyPact CVS)
- Sub-Incomer - DP RCCB/RCBO
- Outgoing - SP MCBs

### PPI TPN DB



Description	Total Module Cutout (no. of rows x No. of modules per row)	Double Door Metal (IP43)	No of Ways	Unit MRP [₹]
6 Way TPN PPI DB	8 + 2 x 3 + 4 x 3	A9HTPI06	6 Ways	10194
8 Way TPN PPI DB	8 + 2 x 3 + 6 x 3	A9HTPI08	8 Ways	11824
12 Way TPN PPI DB	8 + 2 x 3 + 10 x 3	A9HTPI12	12 Ways	16267

### PPI Flexi Tier DB

Description	Total Module Cutout (no. of rows x No. of modules per row)	Double Door Metal (IP43)	No of Ways	Unit MRP [₹]
4T40M Flexi PPI DB	4 x 10	A9HFP110	10	15786
4T56M Flexi PPI DB	4 x 14	A9HFP114	14	17773

### Phase Segregated DBs



- Phase Segregated DBs to provide total safety for installer and maintenance personnel, by compartmentalizing each Phase and separating Incomer, Sub-Incomer and Outgoing
- Offers better continuity of supply in case of faults during maintenance at DB level.
- Incomer - Modular (FP MCB/Isolator) / MCCB 100A (TP/FP during maintenance Compact NSX or EasyPact CVS)
- Sub-Incomer - DP RCCB/RCBO
- Outgoing - SP MCBs
- GI sheet ensures improved rust resistance
- Type-tested system conforming IEC 61439-3
- Built-in 8th segment (for modular incomer only)
- Increased incomer DIN space of 12M for 6 ways to 12 ways
- Split door for all variants
- New design ensures clean alignment of doors, centerplates
- 4 piece architecture with removable frame
- Improved, intuitive door lock design with clear indication of lock and unlock positions

Description	Total Module Cutout (Additional segment + Incomer + Sub-incomer + Outgoing)	Double Door Metal (IP43) Reference	Unit MRP [₹]
4 way	4 + 8 + (3*4) + (3*4)	A9HPSG04	15374
6 way	4 + 12 + (3*4) + (3*6)	A9HPSG06	17190
8 way	4 + 12 + (3*4) + (3*8)	A9HPSG08	19194
12 way	4 + 12 + (3*4) + (3*12)	A9HPSG12	24095
12 way with MCCB I/c	0 + 100A MCCB + (3*4) + (3*12)	A9HPSG12M	32513

**Note:** For all above Reference MOQ = 1

Please contact Customer Care Center for Stockable and Non stockable status of references.

NORMAL STOCK ITEMS

W.E.F. January 17<sup>th</sup>, 2024

### VTPN DBs for Modular Incomer



- Ideal solution to distribute power supply to both 3 Phase and 1 Phase loads in the same DB
- Incomer - FP RCCB / RCBO / Isolator / MCB
- Outgoing - SP MCBs / TP MCBs
- 65% more Incomer Wiring Space.
- New Compact Fishbone with better Thermal Performance
- Short Circuit Withstand – 17 kA for 250mS (100 A)/ 25 kA (250 A) for 500mS
- Secure Connections with Fixed Spreader links
- IP 2X protection at Incomer with new shrouds
- Type tested as per IEC 61439 – 3 in NABL accredited Lab
- Knockout size for Incomer increased to 50mm (to accommodate Aluminium Cable)

Description	Total Module Cutout (Incomer + Outgoing)	Double Door Metal (IP43) Reference	No of Ways	Unit MRP [₹]
Acti9 VTPN DB 4 Ways Modular i-c 63A	12 + 12	A9HVM04	4 Ways	14960
Acti9 VTPN DB 8 Ways Modular i-c 63A	12 + 24	A9HVM08	8 Ways	19037
Acti9 VTPN DB 12 Ways Modular i-c 63A	12 + 36	A9HVM12	12 Ways	25467

### VTPN DBs for MCCB Incomer



- DBs for higher incoming current distribution up to 250A
- Incomer - TP/FP Compact NSX or EasyPact CVS MCCB up to 250A
- Outgoing - SP MCBs / TP MCBs
- 65% more Incomer Wiring Space.
- New Compact Fishbone with better Thermal Performance
- Short Circuit Withstand – 17 kA for 250mS (100 A)/ 25 kA (250 A) for 500mS
- Secure Connections with Fixed Spreader links
- IP 2X protection at Incomer with new shrouds
- Type tested as per IEC 61439 – 3 in NABL accredited Lab
- Knockout size for Incomer increased to 50mm (to accommodate Aluminium Cable)

Description	Total Module Cutout (Incomer + Outgoing)	Double Door Metal (IP43) Reference	No of Ways	Unit MRP [₹]
Acti9 VTPN DB 4 Ways MCCB i-c 100A	100 A MCCB + 12	A9HVN04L	4 Ways	16382
Acti9 VTPN DB 4 Ways MCCB i-c 160A	160 A MCCB + 12	A9HVN04M	4 Ways	18035
Acti9 VTPN DB 8 Ways MCCB i-c 100A	100 A MCCB + 24	A9HVN08L	8 Ways	20763
Acti9 VTPN DB 8 Ways MCCB i-c 160A	160 A MCCB + 24	A9HVN08M	8 Ways	22467
Acti9 VTPN DB 8 Ways MCCB i-c 250A	250 A MCCB + 24	A9HVN08H	8 Ways	28803
Acti9 VTPN DB 12 Ways MCCB i-c 100A	100 A MCCB + 36	A9HVN12L	12 Ways	27600
Acti9 VTPN DB 12 Ways MCCB i-c 160A	160 A MCCB + 36	A9HVN12M	12 Ways	29983
Acti9 VTPN DB 12 Ways MCCB i-c 250A	250 A MCCB + 36	A9HVN12H	12 Ways	34072

## Mivan Compatible DB

### SPN DBs

Description	Total Module Cutout (Incomer + Outgoing)	Double Door Metal (IP43) Reference	No of Ways	Unit MRP [₹]
Acti9 DB 6 way SPN DD 1.6mm	2 + 4	A9HSND06Z	6 Ways	On Request
Acti9 DB 8 way SPN DD 1.6mm	2 + 6	A9HSND08Z	8 Ways	On Request
Acti9 DB 12 way SPN DD 1.6mm	2 + 10	A9HSND12Z	12 Ways	On Request
Acti9 DB 18 way SPN DD 1.6mm	2 + 16	A9HSND18Z	18 Ways	On Request

### TPN DBs

Description	Total Module Cutout (Incomer + Outgoing)	Double Door Metal (IP43) Reference	No of Ways	Unit MRP [₹]
Acti9 DB 4 way TPN DD 1.6mm	8 + 4 x 3	A9HTND04Z	4 Ways	On Request
Acti9 DB 6 way TPN DD 1.6mm	8 + 6 x 3	A9HTND06Z	6 Ways	On Request
Acti9 DB 8 way TPN DD 1.6mm	8 + 8 x 3	A9HTND08Z	8 Ways	On Request
Acti9 DB 12 way TPN DD 1.6mm	8 + 12 x 3	A9HTND12Z	12 Ways	On Request

Please contact Customer Care Center for Stockable and Non stockable status of references.

NORMAL STOCK ITEMS

W.E.F. January 17<sup>th</sup>, 2024

## Phase Segregated DBs (Mivan Compatible)

Description	Total Module Cutout (Additional segment + Incomer + Sub-incomer + Outgoing)	Double Door Metal (IP43) Reference	No of Ways	Unit MRP [₹]
Acti9 DB 4 way PSG DD 1.6mm	4 + 8 + (3*4) + (3*4)	A9HPSG04Z	4 ways	On Request
Acti9 DB 6 way PSG DD 1.6mm	4 + 12 + (3*4) + (3*6)	A9HPSG06Z	6 ways	On Request
Acti9 DB 8 way PSG DD 1.6mm	4 + 12 + (3*4) + (3*8)	A9HPSG08Z	8 ways	On Request
Acti9 DB 12 way PSG DD 1.6mm	4 + 12 + (3*4) + (3*12)	A9HPSG12Z	12 ways	On Request

## Flexi Tier DBs (Mivan Compatible)

Description	Total Module Cutout (no. of rows x No. of modules per row)	Double Door Metal (IP43) Reference	No of Modules Per Row	Unit MRP [₹]
4 Tier 40 Modules	4 x 10	A9HFD440Z	10	On Request
4 Tier 56 Modules	4 x 14	A9HFD456Z	14	On Request

## TV TEL DB

Description	Double Door Metal (IP30) Reference	Unit MRP [₹]
Acti9 DB TVTEL BOX 1mm IP30	A9HTVTEL	On Request
Acti9 DB TVTEL & ONT BOX 1.2MM IP30	A9HOTVTEL	On Request

**Note:** For all above Reference MOQ = 1

## Metal Clad P&amp;S Units



- Plug & Socket Unit with Electra Plug & Socket and provision to mount modular protection devices to feed the end load directly

Description	Total Module Cutout	Single Door (IP30) Reference	Unit MRP [₹]
10A 1P+N+E P&S	2	A9HMS210	2685
20A 1P+N+E P&S	2	A9HMS220	2873
30A 3P+E P&S	3	A9HMS330	6289

Please contact Customer Care Center for Stockable and Non stockable status of references.

NORMAL STOCK ITEMS

W.E.F. January 17<sup>th</sup>, 2024

### Industrial P&S Units ( provision to mount PratiKa Sockets)



- Plug & Socket Unit with provision to mount PratiKa straight / angled\* socket and modular protection devices to feed the end load directly

Description	Total Module Cutout	Single Door (IP30) Reference	Unit MRP [₹]
16A 3P PK P&S	2	A9HKS316	2482
32A 3P PK P&S	2	A9HKS332	4100
32A 5P PK P&S	4	A9HKS532	4856
63A 5P PK P&S	4	A9HKS563	9806

### Locks for Acti 9 DBs

Key Lock\*



Lock & Unlock symbol on door for easy & intuitive operation

Description	Reference	Unit MRP [₹]
New Rotary Lock**	A9HRL901	795

**Note:** \*\*Use New Rotary lock reference A9HRL901 for:  
Acti9 DBs manufactured September 2020 onwards  
Acti9 DBs with lock & unlock symbol on door.

## Accessories for Distribution Boards

## Wire Way Box for Double Door IP43 DBs

Description	Reference	Unit MRP [₹]
Wire way box for A9HSND06 AC 848	A9HSND06WB	1967
Wire way box for A9HSND08 AC 848	A9HSND08WB	2377
Wire way box for A9HSND12 AC 848	A9HSND12WB	2650
Wire way box for A9HSND18 AC 848	A9HSND18WB	3785
Wire way BOX FOR A9HTND04E - PM 163	A9HTND04EWB	2731
Wire way box for A9HTND04 AC 849	A9HTND04WB	3020
Wire way box for A9HTND06 AC 849	A9HTND06WB	3203
Wire way box for A9HTND08 AC 849	A9HTND08WB	3785
Wire way box for A9HTND12 AC 849	A9HTND12WB	4421
Wire way BOX FOR A9HFD224 AC 850	A9HFD224WB	2816
Wire way BOX FOR A9HFD336 AC 850	A9HFD336WB	2788
Wire way BOX FOR A9HFD440 AC 850	A9HFD440WB	2695
Wire way BOX FOR A9HFD456 AC 850	A9HFD456WB	3020
WWB Acti9 PSG DB 8 Seg 4 Ways MCB i/c	A9HPSG04WWB	3896
WWB Acti9 PSG DB 8 Seg 6 Ways MCB i/c	A9HPSG06WWB	4559
WWB Acti9 PSG DB 8 Seg 8 Ways MCB i/c	A9HPSG08WWB	5100
WWB Acti9 PSG DB 8 Seg 12 Ways MCB i/c	A9HPSG12WWB	6610
WWB Acti9 PSG DB 7 Seg 12 Ways MCCB i/c	A9HPSG12MWWB	7060
WWB for Std VTPN DB MCB i/c AC034	A9HVMXXWB	2866
WWB for Std VTPN DB MCCB i/c AC035	A9HVNXXWB	3050

## Modular Distribution Boards - Metallic

Description	Reference	Unit MRP [₹]
<b>Busbars</b>		
Fork Busbar 1P 12MOD. 63A	R9XFH112	1075
Fork Busbar 1P 57MOD. 63A	R9XFH157	2393
Fork Busbar 2P 12MOD. 63A	R9XFH212	1239
Fork Busbar 2P 57MOD. 63A	R9XFH257	4590
Fork Busbar 3P 12MOD. 63A	R9XFH312	2797
Fork Busbar 3P 57MOD. 63A	R9XFH357	10012
Fork Busbar 4P 12MOD. 63A	R9XFH412	2580
Fork Busbar 4P 57MOD. 63A	R9XFH457	10775
<b>Busbar Accessories</b>		
Set of 10 End Caps 1P	R9XE110	*
Set of 10 End Caps 2P	R9XE210	*
Set of 10 End Caps 3P	R9XE310	1131
Set of 10 End Caps 4P	R9XE410	*
Set of 20 Tooth Caps	R9XT20	1359
Blanking Plate	13229B	56

**Note:** Blanking Plate MOQ = 10, All other MOQ = 1

## Customized Distribution Boards to Suit Your Need - Available on Request\*

- TV/Telephone DBs
- Pre-Wired DBs
- 8 Segment DBs
- Acrylic Door DBs
- IP54 DBs
- DBs with Phase Indication Lamps

\*upto 32A socket only

**Note:** For all above Reference MOQ = 1

**Note:** \* Please contact nearest Schneider Electric Sales Office or Customer Care Center for coordination chart

Please contact Customer Care Center for Stockable and Non stockable status of references.

NORMAL STOCK ITEMS

W.E.F. January 17<sup>th</sup>, 2024



Kaedra enclosures for PratiKa industrial sockets are part of a complete system of Watertight enclosures from 16A to 125A providing solutions for protection, control and electrical distribution for tertiary and industrial applications



- Degree of protection - IP65
- Impact strength - IK09
- Resistant to chemical and atmospheric agents, UVs etc.
- Self extinguishing class 2 insulating material
- Flame and abnormal heat resistance: 650°C
- Reversible front face for opening of door to left/right
- Combining of enclosures horizontally/vertically while still maintaining IP
- DIN channel can be positioned in 2 depths & 2 heights for cabling purpose

## Mini Enclosures for modular devices



Description	Reference	Unit MRP [₹]
4 module	13441 <input checked="" type="checkbox"/>	4245
6 module	13442	4831
8 module	13443	5689
12 module	13444	9141

## Enclosures for modular devices (with terminal blocks)



Description	Reference	Unit MRP [₹]
1 row 12 module	13431	10088
1 row 18 module	13432	13296
2 row 24 module	13433	15099
2 row 36 module	13434	19114
3 row 36 module	13435	19930
4 row 72 module	13437	38040

## Mini Enclosure (suitable to mount modular devices and PratiKa 16A socket)



Description	Reference	Unit MRP [₹]
4 module 1 vertical opening	13175 <input checked="" type="checkbox"/>	2025
4 module 2 horizontal opening	13176	2498
4 module 3 horizontal opening	13177	3144

**Note:** For all above Reference MOQ = 1

Please contact Customer Care Center for Stockable and Non stockable status of references.

NORMAL STOCK ITEMS

W.E.F. January 17<sup>th</sup>, 2024

Enclosure (suitable to mount modular devices and PratiKa 16A / 32A sockets)



Description	Reference	Unit MRP [₹]
5 module 2 opening	13178 <input checked="" type="checkbox"/>	4874
8 module 4 horizontal opening	13179	6653
13 module 3 opening	13180	8791
13 module 6 opening	13181	9664
19 module 8 opening	13182	12454

## Functional Plaques



Description	Reference	Unit MRP [₹]
Blank - marked for 1 socket 50x50	13135	630
Blank - marked for 1 socket 65x65 or 75x75	13137	630
Intermediate with 65x85 opening	13136	769
Intermediate with one opening for 65x85 & 90x100	13142	1275

**Note:** For all above Reference MOQ = 1

Please contact Customer Care Center for Stockable and Non stockable status of references.

NORMAL STOCK ITEMS

W.E.F. January 17<sup>th</sup>, 2024

Wander Plugs



- Conforms to IEC 60309-1 & IEC 60309-2
- PK PratiKa Screw Connect: same orientation of clamp's screws
- External impact strength: IK08
- Glow wire test: 850°C

[In] Rated Current (A)	[Ue] Rated Operational Voltage (V)	Poles Description	Reference	Unit MRP [₹]
<b>PratiKa Screw</b>				
<b>IP44</b>				
16	200...250	2P + E	PKE16M423 ✓	607
		2P + E	PKX16M423 ●	1,226
	380...415	3P + E	PKE16M434 ✓	768
		3P + N + E	PKE16M435 ✓	800
32	200...250	2P + E	PKE32M423 ✓	954
	380...415	3P + E	PKE32M434	1108
		3P + N + E	PKE32M435 ✓	1,092
<b>IP67</b>				
16	200...250	2P + E	PKE16M723 ✓	1,325
		2P + E	PKX16M723 ●	1,950
	380...415	3P + E	PKE16M734	1,497
		3P + N + E	PKE16M735	1,600
32	200...250	2P + E	PKE32M723	1,875
	380...415	3P + E	PKE32M734 ✓	2,023
		3P + N + E	PKE32M735 ✓	2,038
<b>PK (63A &amp; 125A available in IP67 only)</b>				
63	200...250	2P + E	81378	5,316
	380...415	3P + E	81382 ✓	5,068
125		380...415	3P + N + E	81383 ✓
	3P + E		81394	15,503
		3P + N + E	81395	15,503

Note: \* Fast Connection

Small Wall Mounted Sockets



- Conforms to IEC 60309-1 & IEC 60309-2
- External impact strength: IK08
- Glow wire test: 850°C

[In] Rated Current (A)	[Ue] Rated Operational Voltage (V)	Poles Description	Reference	Unit MRP [₹]
<b>IP44</b>				
16	200...250	2P + E	PKF16W423	1062
		3P + E	PKF16W434	1232
	380...415	3P + N + E	PKF16W435	1346
32	200...250	2P + E	PKF32W423	1388
	380...415	3P + E	PKF32W434	1666
		3P + N + E	PKF32W435	1759
<b>IP67</b>				
16	200...250	2P + E	PKF16W723	1687
		3P + E	PKF16W734	2119
	380...415	3P + N + E	PKF16W735	2191
32	200...250	2P + E	PKF32W723	2111
	380...415	3P + E	PKF32W734	3083
		3P + N + E	PKF32W735	4089

Note: For all above Reference MOQ = 1

Please contact Customer Care Center for Stockable and Non stockable status of references.

✓ NORMAL STOCK ITEMS

W.E.F. January 17<sup>th</sup>, 2024

Wall Mounted Sockets



- Conforms to IEC 60309-1 & IEC 60309-2
- Rated operational voltage upto 415V
- Rated operational current upto 125A
- External impact strength: IK08
- Glow wire test: 850°C
- Available only in IP67

[In] Rated Current (A)	[Ue] Rated Operational Voltage (V)	Poles Description	Reference	Unit MRP [₹]
63	200...250	2P + E	81178	6549
		3P + E	81182 ●	6740
	380...415	3P + N + E	81183	6837
125	380...415	3P + E	81194	23618
		3P + N + E	81195	23733

Wander Sockets



- PK PratiKa Screw Connect: same orientation of clamp's screws.
- PK PratiKa: 16A & 32A; IP44 & IP67
- External impact strength: IK08
- Glow wire test: 850 °C
- Conforms to IEC 60309-1 & IEC 60309-2

[In] Rated Current (A)	[Ue] Rated Operational Voltage (V)	Poles Description	Reference	Unit MRP [₹]
<b>PratiKa Screw</b>				
<b>IP44</b>				
16	200...250	2P + E	PKF16M423 ✓	840
		2P + E	PKY16M423	926
	380...415	3P + E	PKF16M434	969
		3P + N + E	PKF16M435	1057
32	200...250	2P + E	PKF32M423 ✓	1155
		3P + E	PKF32M434	1402
	380...415	3P + N + E	PKF32M435 ✓	1411
<b>IP67</b>				
16	200...250	2P + E	PKF16M723	1555
		2P + E	PKY16M723 ●	1892
	380...415	3P + E	PKF16M734	1950
		3P + N + E	PKF16M735	2038
32	380...415	2P + E	PKF32M723	2139
		3P + E	PKF32M734	2367
	3P + N + E	PKF32M735	2389	
<b>PK (63A &amp; 125A available in IP67 only)</b>				
63	200...250	2P + E	81478	5790
		3P + E	81482	5841
	380...415	3P + N + E	81483	5936
125	380...415	3P + E	81494	18278
		3P + N + E	81495	18636

Also Available on Request:

- Patented FAST connect Plugs & Sockets - innovative cabling system that enables connection without stripping the conductor and with absolutely no screws required
  - Extra Low Voltage Plugs & Sockets down to 50V
- Please contact nearest Schneider Electric Sales Office or Customer Care for Reference and Prices

Note: For all above Reference MOQ = 1

Please contact Customer Care Center for Stockable and Non stockable status of references.

✓ NORMAL STOCK ITEMS

W.E.F. January 17<sup>th</sup>, 2024

Panel Mounted Sockets - Angled



- PK PratiKa Screw Connect: same orientation of clamp's screws
- External impact strength: IK08
- Glow wire test: 850°C
- Conforms to IEC 60309-1 & IEC309-2

[In] Rated Current (A)	[Ue] Rated Operational Voltage (V)	Poles Description	Reference	Unit MRP [₹]
<b>PratiKa Screw</b>				
<b>IP44</b>				
16	200...250	2P + E	PKF16F423 <input checked="" type="checkbox"/>	650
		2P + E	PKY16F423 <input type="checkbox"/>	701
	380...415	3P + E	PKF16F434	969
		3P + N + E	PKF16F435 <input checked="" type="checkbox"/>	1033
32	200...250	2P + E	PKF32F423 <input checked="" type="checkbox"/>	1155
	380...415	3P + E	PKF32F434	1340
		3P + N + E	PKF32F435	1335
<b>IP67</b>				
16	200...250	2P + E	PKF16F723 <input checked="" type="checkbox"/>	1224
	380...415	2P + E	PKY16F723 <input type="checkbox"/>	1483
		3P + E	PKF16F734	1394
32	200...250	3P + N + E	PKF16F735 <input checked="" type="checkbox"/>	1411
	380...415	2P + E	PKF32F723	1593
		3P + E	PKF32F734	1862
		3P + N + E	PKF32F735	1892
<b>PK (63A &amp; 125A available in IP67 only)</b>				
63	200...250	2P + E	81278	5228
	380...415	3P + E	81282 <input checked="" type="checkbox"/>	5236
		3P + N + E	81283 <input checked="" type="checkbox"/>	5339
125	380...415	3P + E	81294	17637
		3P + N + E	81295	17723

Panel Mounted Sockets - Straight



- PK PratiKa Screw Connect: same orientation of clamp's screws
- External impact strength: IK08
- Glow wire test: 850°C
- Conforms to IEC 60309-1 & IEC309-2

[In] Rated Current (A)	[Ue] Rated Operational Voltage (V)	Poles Description	Reference	Unit MRP [₹]
<b>PratiKa Screw</b>				
<b>IP44</b>				
16	200...250	2P + E	PKF16G423	736
		2P + E	PKY16G423 <input type="checkbox"/>	1091
	380...415	3P + E	PKF16G434	1284
		3P + N + E	PKF16G435 <input checked="" type="checkbox"/>	1108
32	200...250	2P + E	PKF32G423	1169
	380...415	3P + E	PKF32G434	1346
		3P + N + E	PKF32G435	1458
<b>IP67</b>				
16	200...250	2P + E	PKF16G723	1232
	380...415	2P + E	PKY16G723 <input type="checkbox"/>	1388
		3P + E	PKF16G734	1694
32	200...250	3P + N + E	PKF16G735 <input checked="" type="checkbox"/>	1411
		2P + E	PKF32G723	1571
	380...415	3P + E	PKF32G734	1768
		3P + N + E	PKF32G735	1834
<b>PK (63A &amp; 125A available in IP67 only)</b>				
63	380...415	3P + E	81682	5288
125		3P + N + E	81683 <input checked="" type="checkbox"/>	5288
		3P + N + E	81695	17723

\*Fast Connection

**Note:** For all above Reference MOQ = 1

Please contact Customer Care Center for Stockable and Non stockable status of references.

NORMAL STOCK ITEMS

W.E.F. January 17<sup>th</sup>, 2024

## Sockets with Interlock Switches - for guaranteed safety of operation

- Allows closure of main switch only when the plug is fully inserted in socket - when complete mechanical & electrical connection has occurred
- Plug removal is possible only when the switch is in "off" position

## Wall Mounted Sockets with Interlock Switch Unika (w/o protection)



83047

83081

- Switch designed for use in AC 22A class applications
- Conforms to IEC 60309-1 & IEC 60309-2
- Rated operational voltage upto 415V
- Rated operational current upto 32A
- External impact strength: IK08
- Available in IP44 / IP65 versions
- Glow wire test: 750°C

[In] Rated Current (A)	[Ue] Rated Operational Voltage (V)	Poles Description	Reference	Unit MRP [₹]
<b>IP44</b>				
16	200...250	2P + E	83031	8837
	380...415	3P + N + E	83036	12472
32	200...250	2P + E	83042 <input checked="" type="checkbox"/>	11472
	380...415	3P + E	83046	18569
		3P + N + E	83047	13519
<b>IP65</b>				
16	200...250	2P + E	83081	9143
	380...415	3P + E	83085	12591
		3P + N + E	83086	12847
32	200...250	2P + E	83092	11983
	380...415	3P + N + E	83097	14388

## Socket with Interlock Switch &amp; DIN Rail Isoblock (4.5 modules)



82754

83796

- Switch designed for use in AC- 22A class applications
- Conforms to IEC 60309-1 & IEC 60309-2
- Provision to DIN mount 4.5 module device
- External impact strength: IK10
- Available in IP65 version
- Glow wire test: 850°C

[In] Rated Current (A)	[Ue] Rated Operational Voltage (V)	Poles Description	Reference	Unit MRP [₹]
16	200...250	2P + E	82754 <input checked="" type="checkbox"/>	10955
	380...415	3P + N + E	82759	16752
32	200...250	2P + E	83791 <input checked="" type="checkbox"/>	12970
	380...415	3P + E	83795	18651
		3P + N + E	83796	15452

## Socket with Interlock Switch &amp; DIN Rail Isoblock (6 modules)



82766

82771

- Switch designed for use in AC- 22A class applications
- Conforms to IEC 60309-1 & IEC 60309-2
- Provision to DIN mount 6 module device
- External impact strength: IK10
- Available in IP65 version
- Glow wire test: 850°C

[In] Rated Current (A)	[Ue] Rated Operational Voltage (V)	Poles Description	Reference	Unit MRP [₹]
32	200...250	2P + E	82766	17,110
63	380...415	3P + E	82782	23,055
		3P + N + E	82783	23,128

**Note:** For all above Reference MOQ = 1

Please contact Customer Care Center for Stockable and Non stockable status of references.

NORMAL STOCK ITEMS

W.E.F. January 17<sup>th</sup>, 2024

**ELECTRA Metal Clad Plugs & Sockets are specially designed incorporating the latest safety, quality and user friendly features.**

**Construction**

- The casting is made from non-corroding die-cast aluminum alloy combining exceptional compactness with high strength
- The design/construction eliminates the possibility of mismatch in fitting of plugs in corresponding sockets
- The floating contacts in the sockets are self aligning and facilitates smooth plugging in without undue pressure (These can be easily removed for wiring )
- A provision for pilot pin facilitates mechanical interlocking in case of 63A ratings

**Human Safety**

Specially designed shroud to avoid accidental finger contact with plug-pins while inserting/removing the plug  
Similarly, the contact tubes in sockets are deeply recessed to avoid human contact

- The earthing pins ensure that earth connection is made first and broken last, being longer than conducting pins
- The visible earth terminals facilitate easy checking of earth connection
- The cable grip to the plug is made very strong by providing a compression gland and by protecting it at the point of entry by a strong rubber guard

**Applications**

Industrial, Commercial & Domestic portable equipments like Hand/Power Tools, Industrial Ovens, Welding Sets, Mobile Generators, Furnaces, Ships, Office Machines, Refrigerators, Coolers, Air-Conditioners, Overhead Cranes, Chilling Cabinets, Tile Polishers and Sewing Machines

**Plug**



Rating (A)	Poles Description	Voltage (V)	MOQ	Reference	Unit MRP [₹]
10	2P	250	30	AP10 <input checked="" type="checkbox"/>	283
20	2P	250	30	AP20 <input checked="" type="checkbox"/>	298
20	3P	440	30	BP20 <input checked="" type="checkbox"/>	396
30	3P	440	20	BP30 <input checked="" type="checkbox"/>	721
63	3P+N+E	440	4	CP63 <input checked="" type="checkbox"/>	3261

**Socket**



Rating (A)	Poles Description	Voltage (V)	MOQ	Reference	Unit MRP [₹]
10	2P	250	30	AS10 <input checked="" type="checkbox"/>	298
20	2P	250	30	AS20 <input checked="" type="checkbox"/>	317
20	3P	440	30	BS20 <input checked="" type="checkbox"/>	445
30	3P	440	20	BS30 <input checked="" type="checkbox"/>	763
63	3P+N+E	440	4	CS63 <input checked="" type="checkbox"/>	3653

Please contact Customer Care Center for Stockable and Non stockable status of references.

NORMAL STOCK ITEMS

W.E.F. January 17<sup>th</sup>, 2024

Complete range of switches & sockets suitable for both indoor & outdoor applications like Kitchens, Swimming Pools, Landscape Gardens, Exterior Walls and Other Environmentally Challenged Locations.



56SW116LE-GY



56SW216LE-GY



56SW332LE-GY

Description	IP Rating	Reference	Unit MRP [₹]
<b>Surface Switches</b>			
<b>Single Pole Switches Less Enclosure</b>			
1 Pole 250V 10A	IP66	56SW110LE-GY	3896
1 Pole 250V 16A	IP66	56SW116LE-GY	3650
1 Pole 250V 20A	IP66	56SW120LE-GY	5527
1 Pole 250V 32A	IP66	56SW132LE-GY	6528
<b>Double Pole Switches Less Enclosure</b>			
2 Pole 500V 16A	IP66	56SW216LE-GY	6307
2 Pole 500V 20A	IP66	56SW220LE-GY	6307
2 Pole 500V 32A	IP66	56SW232LE-GY	8369
2 Pole 500V 50A	IP66	56SW250LE-GY	9773
<b>Triple Pole Switches Less Enclosure</b>			
3 Pole 500V 10A	IP66	56SW310LE-GY	5833
3 Pole 500V 16A	IP66	56SW316LE-GY	6085
3 Pole 500V 20A	IP66	56SW320LE-GY	6406
3 Pole 500V 32A	IP66	56SW332LE-GY	7469
3 Pole 500V 50A	IP66	56SW350LE-GY	8617
3 Pole 500V 63A	IP66	56SW363LE-GY	10003
<b>Four Pole Switches Less Enclosure</b>			
4 Pole 500V 20A	IP66	56SW420LE-GY	8457



66CV563-RG



66P563-EO

Description	IP Rating	Reference	Unit MRP [₹]
<b>IP66 Industrial Combination Switch Sockets with Enclosure</b>			
<b>Single Pole Switches Less Enclosure</b>			
500V, 63A with 4 pole switch and 63A 5 Pin Socket	IP66	66CV563-RG	113367
Plug Top 5 Pin 500V 63A	IP66	66P563-EO	34027

Please contact Customer Care Center for Stockable and Non stockable status of references.

NORMAL STOCK ITEMS

W.E.F. January 17<sup>th</sup>, 2024





56SO316RP-LE-GY-EX



56SO432LE-GY



56SO532LE-GY

Description	IP Rating	Reference	Unit MRP [₹]
<b>Surface Socket Outlets</b>			
<b>3 Pin Sockets Less Enclosure</b>			
3 Pin 250V 16A Indian Standard	IP66	56SO316RP-LE-GY-EX	3674
3 Pin 250V 20A Round Pin	IP66	56SO320LE-GY	5334
3 Pin 250V 32A Round Pin	IP66	56SO332LE-GY	5885
<b>4 Pin Sockets Less Enclosure</b>			
4 Pin 500V 20A Round Pin	IP66	56SO420LE-GY	7891
4 Pin 500V 32A Round Pin	IP66	56SO432LE-GY	9435
4 Pin 500V 50A Round Pin	IP66	56SO450LE-GY	14517
<b>5 Pin Sockets Less Enclosure</b>			
5 Pin 500V 10A Round Pin	IP66	56SO510LE-GY	8527
5 Pin 500V 20A Round Pin	IP66	56SO520LE-GY	8527
5 Pin 500V 32A Round Pin	IP66	56SO532LE-GY	10126
5 Pin 500V 40A Round Pin	IP66	56SO540LE-GY	14610
5 Pin 500V 50A Round Pin	IP66	56SO550LE-GY	15000

\*Alternate reference 56SO440-GY (coming soon)



56PA420-EO



56PA532-EO



56CVI520-GY

Description	IP Rating	Reference	Unit MRP [₹]
<b>Plugs</b>			
<b>3 Pin Angle Plugs</b>			
3 pin 250V 16A Round P in	IP66	56PA316RP-GY-EX	2763
3 Pin 250V 20A Round Pin	IP66	56PA320-EO	5527
3 Pin 250V 32A Round Pin	IP66	56PA332-EO	6324
<b>4 Pin Angle Plugs</b>			
4 Pin 500V 20A Round Pin	IP66	56PA420-EO	6735
4 Pin 500V 32A Round Pin	IP66	56PA432-EO	7011
4 Pin 500V 40A Round Pin	IP66	56PA440-EO	11661
4 Pin 500V 50A Round Pin	IP66	56PA450-EO	8319
<b>5 Pin Angle Plugs</b>			
5 Pin 500V 10A Round Pin	IP66	56PA510-EO	6620
5 Pin 500V 20A Round Pin	IP66	56PA520-EO	6620
5 Pin 500V 32A Round Pin	IP66	56PA532-EO	7648
5 Pin 500V 40A Round Pin	IP66	56PA540-EO	8089
5 Pin 500V 50A Round Pin	IP66	56PA550-EO	8281
<b>Combination Switch Socket Outlet</b>			
<b>IP66 Interlocked Switch Socket with Enclosure</b>			
4 Pin 500V 20A Round Pin	IP66	56CVI420-GY	28937
5 Pin 500V 20A Round Pin	IP66	56CVI520-GY	26179
5 Pin 500V 32A Round Pin	IP66	56CVI532-GY	26418

Please contact Customer Care Center for Stockable and Non stockable status of references.

NORMAL STOCK ITEMS

W.E.F. January 17<sup>th</sup>, 2024

# 56 Series



56DB2-GY



56CB4N-GY

Description	IP Rating	Reference	Unit MRP [₹]
<b>Adaptable Enclosures with Gear Tray</b>			
2 Gangpoints, 198X101X140mm	IP66	56DB2-GY	7223
<b>Junction Boxes</b>			
1 Gangpoint, 107X101X90mm	IP66	56JB1-GY	3143
2 Gangpoints, 204X101X90mm	IP66	56JB2-GY	5052
3 Gangpoints, 300X101X90mm	IP66	56JB3-GY	10826
4 Gangpoints, 204X198X90mm	IP66	56JB4-GY	10163

Description	Module Width	Reference	Unit MRP [₹]
<b>Switchgear Cover Assembly</b>			
For 1,2,3 Pole MCB with 4 Pole RCD (max. 4M Width)	4	56CB4N-GY	6,000



56FA2-GY



56E2-GY



56E1-GY-EX



56E3-GY

Description	No. of Gangs	Reference	Unit MRP [₹]
<b>Flush Surrounds</b>			
Flush Surround	2	56FA2-GY	2956
Flush Surround	3	56FA3-GY	4654
<b>Mounting Enclosures (Back Boxes)</b>			
101X101X63mm	1	56E1-GY-EX	1374
198X101X63mm	2	56E2-GY	3298
294X101X63mm	3	56E3-GY	5235
198X198X63mm	4	56E4-GY	6735
294X198X63mm	6	56E6-GY	10769
391X198X63mm	8	56E8-GY	14129
391X391X63mm	16	56E16-GY	25600

Please contact Customer Care Center for Stockable and Non stockable status of references.

NORMAL STOCK ITEMS

W.E.F. January 17<sup>th</sup>, 2024

# SWITCH TO STYLE



Perfect solutions for the perfect you



**Clipsal X**



**Opale**



**LIVIA**  
Life. Style.



**Avatar On**



**ZENcelo**



**Unica Pure**

# LIVIA - Switch to the extra-ordinary



- **Sleek Design** - 2.7mm thin plate with curved body to minimize dust accumulation
- **Stylish Looks** - Soft white texture with glossy finish
- **Robust & Strong** - Innovative honeycomb designed grid plate for extra rigidity
- **Reliable** - High grade heat-resistant polycarbonate and laser marked wiring diagrams. Tested for 4 Lac clicks
- **Easy to Install** - Snap-In / Snap-Out front loading modules and Bigger terminal holes
- **Green & Eco Friendly** - RoHS compliant range

**NEW** Livia  
*Pristine Grey*



Description	Reference for White	Unit MRP [₹]	Reference for Pristine Grey	Unit MRP [₹]
<b>Switches</b>				
10AX 1 way switch	P1001_N	139	P1001_PG_N	196
10AX 1 way switch with Indicator lamp	P1081_N	289	P1081_PG_N	361
10AX 2 way switch	P1002_N	229	P1002_PG_N	269
16AX 1 way switch	P1101_N	251	P1101_PG_N	306
16AX 1 way switch with Indicator lamp	P1181_N	346	P1181_PG_N	407
16AX 1 way switch (2M)	P1121_N	359	P1121_PG_N	456
16AX 2 way switch	P1102_N	332	P1102_PG_N	419
20A 1 way switch (1M) with indicator lamp	P11201_N	312	P11201_PG_N	342
20A DP switch with Indicator lamp	P1120_N	560	P1120_PG_N	690
32A DP switch with Indicator lamp	P1132_N	843	P1132_PG_N	999
<b>Bell Push</b>				
10A Bell Push switch	P1005_N	255	P1005_PG_N	301
10A Bell Push switch (2M)	P1025_N	343	P1025_PG_N	400
10A bell push switch with Indicator	P1085_N	309	P1085_PG_N	386
10A bell push switch with Indicator (2M)	P1086_N	400	P1086_PG_N	489
<b>Sockets</b>				
6A 3Pin socket Outlet with shutter (BIS)	P2005NS_N	272	P2005NS_PG_N	325
10A/16A 3-pin Socket Outlet with Shutter	P2106_N	409	P2106_PG_N	487
<b>Fan Regulators &amp; Dimmers</b>				
Step type fan regulator (1M)	P3100_N	788	P3100_PG_N	942
Step type fan regulator (2M)	P3200_N	916	P3200_PG_N	1114
Dimmer 400W (1M)	P3004_N	1387	P3004_PG_N	1783
Dimmer 1000W (2M)	P3012_N	1817	P3012_PG_N	2267
<b>USB Charger</b>				
USB Charger	P7002_N	1998	P7002_PG_N	2267
Livia - A+C Type USB Charger (1M)	P7003_N	2927	P7003_PG_N	3523
<b>Accessories</b>				
RJ 11 Telephone outlet with shutter	P4011_N	225	P4011_PG_N	286
RJ 45 Cat 5e Data outlet with shutter	P4045_N	767	P4045_PG_N	898
RJ 45 Cat6 Data outlet with shutter	P4046_N	854	P4046_PG_N	1077
TV socket	P4500_N	216	P4500_PG_N	279
Blank off unit (1M)	P0001_N	61	P0001_PG_N	76
Foot Lamp with LED	P7001_N	926	P7001_PG_N	1082
Cord Outlet	P4550_N	249	P4550_PG_N	301
LED Phase Indicator	P5001_N	383	-	-

\* Available till stocks lasts

Please contact Customer Care Center for Stockable and Non stockable status of references.

NORMAL STOCK ITEMS

W.E.F. January 17<sup>th</sup>, 2024



P1186MS\_N



P6002\_N



P6004\_N



P0703\_N



P0704\_N



P0703\_PG\_N



P8010\_PG\_N



P8016\_PG\_N



P8020\_PG\_N



P8025\_PG\_N



P8032\_PG\_N



P8010\_PG\_N



P8016\_PG\_N



P8020\_PG\_N



P8025\_PG\_N



P8032\_PG\_N

Description	Reference for White	Unit MRP [₹]	Reference for Pristine Grey	Unit MRP [₹]
<b>Motor Starter Switch</b>				
25A Motor Starter switch	P1186MS_N	1394	P1186MS_PG_N	1687
<b>Hotel Series</b>				
DND Switch	P6002_N	281	P6002_PG_N	332
MMR Switch	P6004_N	281	P6004_PG_N	332
DND & MMR Indicator	P6013_N	898	P6013_PG_N	1072
20A Key Card Switch - Electronic (3M)	P6005_N	5054	P6005_PG_N	6135
<b>Cover Plates</b>				
1-2 M Grid & 1 M Cover Frame	P0701_N	153	P0701_PG_N	179
1-2 M Grid & 2 M Cover Frame	P0702_N	153	P0702_PG_N	182
3 M Grid & 3 M Cover Frame	P0703_N	195	P0703_PG_N	226
4 M Grid & 4 M Cover Frame	P0704_N	226	P0704_PG_N	264
6 M Grid & 6 M Cover Frame	P0706_N	284	P0706_PG_N	348
8 M Grid & 8 M Cover Frame - Horizontal	P0708_N	374	P0708_PG_N	462
8 M Grid & 8 M Cover Frame - Square	P0709_N	451	P0709_PG_N	530
9 M Grid & 9M Cover Frame	P07010_N	424	P07010_PG_N	550
12 M Grid & 12 M Cover Frame	P0712_N	546	P0712_PG_N	642
16 M Grid & 16M Cover Frame	P07016_N	650	P07016_PG_N	776
18 M Grid & 18 M Cover Frame	P0718_N	786	P0718_PG_N	925

Description	Reference for White	Unit MRP [₹]	Box Qty
<b>Livia White</b>			
10A Mini MCB	P8010_N	548	10
16A Mini MCB	P8016_N	548	10
20A Mini MCB	P8020_N	548	10
25A Mini MCB	P8025_N	548	10
32A Mini MCB	P8032_N	548	10

Description	Reference for Pristine Grey	Unit MRP [₹]	Box Qty
<b>Livia Pristine Grey</b>			
10A Mini MCB, PG	P8010_PG_N	642	10
16A Mini MCB, PG	P8016_PG_N	642	10
20A Mini MCB, PG	P8020_PG_N	642	10
25A Mini MCB, PG	P8025_PG_N	642	10
32A Mini MCB, PG	P8032_PG_N	642	10

Please contact Customer Care Center for Stockable and Non stockable status of references.

NORMAL STOCK ITEMS

W.E.F. January 17<sup>th</sup>, 2024

# Clipsal X - As Stylish As Your World



## Xtra STYLE

- Trendy Dual tone colour and finish
- Contemporary sloped design that blends seamlessly with the wall
- Vibrant and youthful colours and textured finishes that can stand out or blend in
- Textured finishes to match most Indian decors – Wood, Slate & Leather

## Xtra STRONG

- Made to last for more than 1 Million Clicks
- 10A rated switches to enable Grouping – add as many loads as you want
- UV Stabilized to avoid decoloring

## Xtra COMFORT

- Least noise level for unobstrusive switching
- Smooth finish which avoids light reflection off the surface
- Glossy Band making it Easy to Clean
- Large plate overhang to hide wall & paint imperfections



CPX101SW1M\_ WE



CPX161SWL1M\_ WE



CPX20DP2M\_ WE



CPX6BP2M\_ WE



CPX6SK3PNS\_ WE



CPXACUSB1P1M\_ WE



CPX5STFAN2M\_ WE



CPX21USB1P1M\_ WE



CPXACUSB1P 1M\_ WE



CPXTVCOAX1M\_ WE



CPXCORD1M\_ WE



CPXDNDIN1M\_ WE



CPXMMRIN1M\_ WE



CPXKEYCARDSW\_ WE

Description	Reference for White	Unit MRP (₹)	Pack	Reference for Coke Grey	Unit MRP (₹)	Pack
<b>Switches</b>						
10AX 1 Way Switch	CPX101SW1M_WE	130	20	CPX101SW1M_GY	233	20
10A X1 Way Switch with Indicator	CPX101SWL1M_WE	320	20	CPX101SWL1M_GY	379	1
10AX 2 Way Switch	CPX102SW1M_WE	272	20	CPX102SW1M_GY	329	20
16AX 1 Way Switch	CPX161SW1M_WE	329	1	CPX161SW1M_GY	405	1
16AX 1 Way Switch with Indicator	CPX161SWL1M_WE	432	20	CPX161SWL1M_GY	511	20
16AX 2 Way Switch	CPX162SW1M_WE	436	1	CPX162SW1M_GY	515	20
10AX 1 Way Switch (2M)	CPX101SW2M_WE	385	1	-	-	-
16AX 1 Way Switch (2M)	CPX161SW2M_WE	462	1	-	-	-
16AX 1W Switch with Indicator (2M)	CPX161SWL2M_WE	531	1	-	-	-
20A DP Switch with Indicator (2M)	CPX20DP2M_WE	731	1	CPX20DP2M_GY	853	1
32A DP Switch with Indicator (2M)	CPX32DP2M_WE	1,112	1	CPX32DP2M_GY*	1683	10
<b>Motor Starter Switch</b>						
25A Motor Starter Switch	CPXMTSTART2M_WE	1,261	10	CPXMTSTART2M_GY	2335	10
<b>Bell Press</b>						
6A Bell Push	CPX6BP1M_WE	306	20	CPX6BP1M_GY	350	1
6A Bell Push (2M)	CPX6BP2M_WE	465	10	CPX6BP2M_GY	543	1
6A Bell Push with Indicator	CPX6BPL1M_WE	423	1	CPX6BPL1M_GY	506	20
6A Bell Push with Indicator (2M)	CPX6BPL2M_WE	506	1	CPX6BPL2M_GY	575	10
<b>Sockets</b>						
6A 3P Socket Outlet with Shutter (BIS Std.)	CPX6SK3PNS_WE	347	10	CPX6SK3PNS_GY	393	10
6A/16A 3P Socket with Shutter	CPX616SK_WE	525	10	CPX616SK_GY	593	10
<b>Fan Regulators and Dimmers</b>						
5-Step Fan Regulator (2M)	CPX5STFAN2M_WE	1,167	1	CPX5STFAN2M_GY	1397	5
4-Step Fan Regulator (1M), White	CPX4STFAN1M_WE	1,064	10	CPX4STFAN1M_GY	1274	10
400W Dimmer (1M)	CPXDIM1M_WE	1,149	1	CPXDIM1M_GY	1401	1
400W Dimmer (2M)	CPXDIM2M_WE	1,816	1	CPXDIM2M_GY	2272	1
1200W Dimmer	CPXDIM2M_1200_WE	2,338	1	CPXDIM2M_1200_GY	2803	5
<b>USB Chargers</b>						
2.1A USB Charger (1M)	CPX21USB1P1M_WE	1,891	1	CPX21USB1P1M_GY	2233	1
2.1A USB Charger (2M)	CPX21USB2P2M_WE	2,663	15	CPX21USB2P2M_GY	3827	15
2.4A A+C USB Charger(1M)	CPXACUSB1P1M_WE	3,228	10	CPXACUSB1P1M_GY	3483	10
<b>Accessories</b>						
RJ11 Tel Outlet, No Shutter	CPXRJ11NS1M_WE	284	5	CPXRJ11NS1M_GY	344	5
RJ11 Tel Outlet with Shutter	CPXRJ11_1M_WE	275	5	CPXRJ11_1M_GY	329	5
Twin RJ11 Tel Outlets (1M)	CPXRJ11TW1M_WE	457	12	CPXRJ11TW1M_GY	521	12
RJ45 Data Outlet with Shutter	CPXRJ451M_WE	940	12	CPXRJ451M_GY	1102	12
TV Socket	CPXTVCOAX1M_WE	258	5	CPXTVCOAX1M_GY	314	5
RJ45 Cover for Keystone Type	CPXRJ45KS1M_WE	322	5	CPXRJ45KS1M_GY	396	5
Gripped Cord Outlet	CPXCORD1M_WE	307	5	-	-	-
Foot Light with LED	CPXFTLP2M_WE	1,231	-	CPXFTLP2M_GY	1463	-
Buzzer	CPXBUZZ2M_WE	1,261	-	CPXBUZZ2M_GY	1321	2
Blank Off Unit (1M)	CPXBLANK1M_WE	72	-	CPXBLANK1M_GY	97	5
<b>Neon Phase Indicator</b>						
Neon Phase Indicator (Green)	CPXPHASEG1M	451	12	-	-	-
Neon Phase Indicator (Red)	CPXPHASER1M	451	12	-	-	-
<b>Hotel Series</b>						
DND Indicator	CPXDNDIN1M_WE	670	12	-	-	-
DND Switch	CPXDNDSW1M_WE	525	1	CPXDNDSW1M_GY	621	1
MMR Indicator	CPXMMRIN1M_WE	670	12	-	-	-
MMR Switch	CPXMMRSW1M_WE	525	1	CPXMMRSW1M_GY	621	20
16A Electronic Keycard Switch	CPXKEYCARDSW_WE	6,104	1	CPXKEYCARDSW_GY	6887	1
Shaver Socket Horizontal	CPXSHAVER_WE	6,310	1	CPXSHAVER_GY	7444	1

Please contact Customer Care Center for Stockable and Non stockable status of references.

✓ NORMAL STOCK ITEMS

W.E.F. January 17<sup>th</sup>, 2024

# Clipsal X - As Stylish As Your World



White

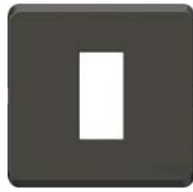

Coke Grey



Metallic Copper



Charcoal Black

Description	Reference for White	Unit MRP [₹]	Pack	Reference for Coke Grey	Unit MRP [₹]	Pack	Reference for Metallic Copper	Unit MRP [₹]	Pack	Reference for Charcoal Black	Unit MRP [₹]	Pack
<b>Cover Plates</b>												
1M or 2M Grid & 1M Cover Frame	CPXCP1M_WE	178	1	CPXCP1M_GY	305	10	CPXCP1M_MC	354	10	CPXCP1M_CB	354	10
1M or 2M Grid & 2M Cover Frame	CPXCP2M_WE	193	10	CPXCP2M_GY	329	10	CPXCP2M_MC	384	10	CPXCP2M_CB	384	10
3M Grid & 3M Cover Frame	CPXCP3M_WE	221	10	CPXCP3M_GY	374	10	CPXCP3M_MC	439	10	CPXCP3M_CB	439	10
3M Uni Grid & 3M Cover Frame	CPXCP3MU_WE	263	10	-	-	-	-	-	-	-	-	-
4M Grid & 4M Cover Frame	CPXCP4M_WE	261	1	CPXCP4M_GY	442	10	CPXCP4M_MC	516	10	CPXCP4M_CB	516	10
6M Grid & 6M Cover Frame	CPXCP6M_WE	378	5	CPXCP6M_GY	642	5	CPXCP6M_MC	751	1	CPXCP6M_CB	751	1
8M Grid & 8M Cover Frame, Horizontal	CPXCP8ML_WE	468	1	CPXCP8ML_GY	795	5	CPXCP8ML_MC	930	5	CPXCP8ML_CB	930	5
8M Grid & 8M Cover Frame, Square	CPXCP8MSQ_WE	506	1	CPXCP8MSQ_GY	984	1	CPXCP8MSQ_MC	1173	1	CPXCP8MSQ_CB	1173	1
9M Cover Frame	CPXCP9M_WE	499	5	CPXCP9M_GY	842	5	-	-	-	-	-	-
9M Grid & 9M Cover Frame	-	-	-	-	-	-	-	-	-	CPXCP9M_CB	1272	5
12M Grid & 12M Cover Frame	CPXCP12M_WE	572	1	CPXCP12M_GY	1154	1	CPXCP12M_MC	1292	5	CPXCP12M_CB	1292	5
16M Cover Frame	CPXCP16M_WE	688	5	CPXCP16M_GY	1123	5	-	-	-	-	-	-
18M Grid & 18M Cover Frame	CPXCP18M_WE	884	5	-	-	-	-	-	-	-	-	-

Please contact Customer Care Center for Stockable and Non stockable status of references.

NORMAL STOCK ITEMS

W.E.F. January 17<sup>th</sup>, 2024



# Clipsal X - As Stylish As Your World



Sheesham



Slate

Description	Reference for Sheesham	Unit MRP [₹]	Pack	Reference for Slate	Unit MRP [₹]	Pack
<b>Cover Plates</b>						
1M or 2M Grid & 1M Cover Frame	CPXCP1M_SH	560	10	CPXCP1M_SL	598	10
1M or 2M Grid & 2M Cover Frame	CPXCP2M_SH	607	1	CPXCP2M_SL	607	1
3M Grid & 3M Cover Frame	CPXCP3M_SH	693	10	CPXCP3M_SL	693	10
4M Grid & 4M Cover Frame	CPXCP4M_SH	816	1	CPXCP4M_SL	816	1
6M Grid & 6M Cover Frame	CPXCP6M_SH	1185	1	CPXCP6M_SL	1265	1
8M Grid & 8M Cover Frame, Horizontal	CPXCP8ML_SH	1470	5	CPXCP8ML_SL	1470	5
8M Grid & 8M Cover Frame, Square	CPXCP8MSQ_SH	1736	1	CPXCP8MSQ_SL	1854	1
12M Grid & 12M Cover Frame	CPXCP12M_SH	2038	5	CPXCP12M_SL	2177	5

Please contact Customer Care Center for Stockable and Non stockable status of references.

NORMAL STOCK ITEMS

W.E.F. January 17<sup>th</sup>, 2024

# Wiring Diagram Clipsal X

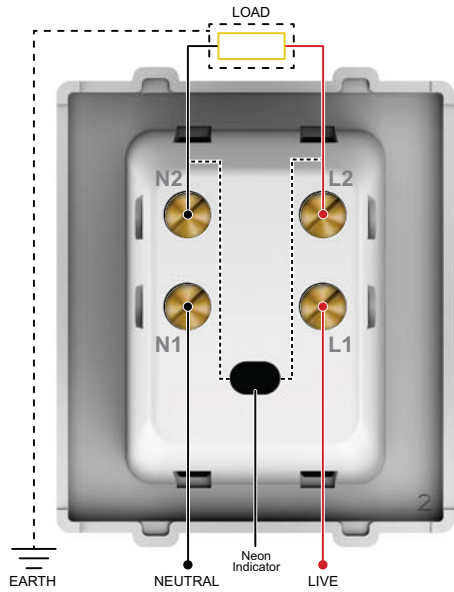

> 20A DP Switch with Indicator (2M)  
CPX20DP2M\_WE, CPX20DP2M\_GY

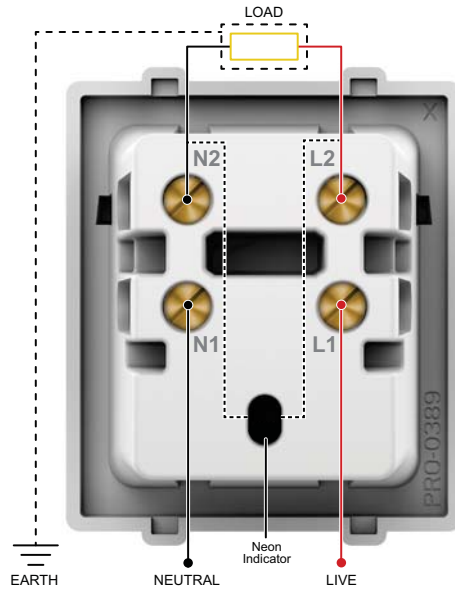

> 32A DP Switch with Indicator (2M)  
CPX32DP2M\_WE, CPX32DP2M\_GY

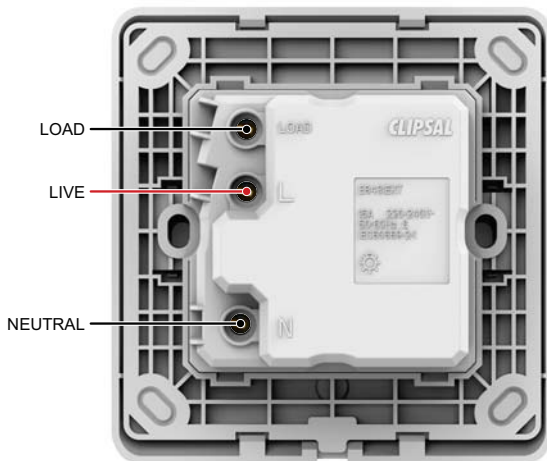

> 16A Electronic Keycard Switch  
CPXKEYCARDSW\_WE, CPXKEYCARDSW\_GY

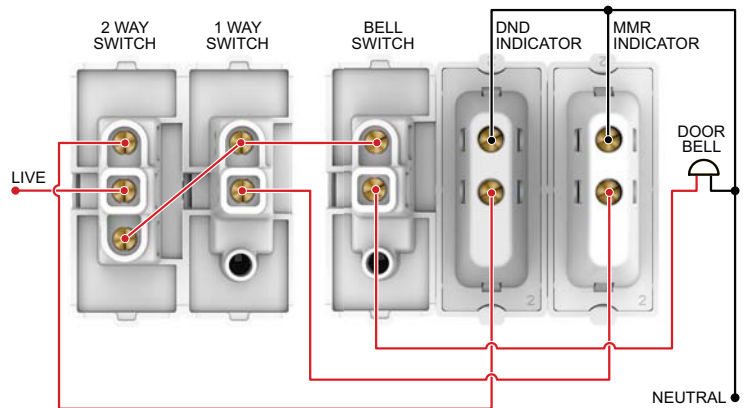

> DND Switch > MMR Switch  
> DND Indicator > MMR indicator  
CPXDND1M\_WE, CPXDND1M\_GY,  
CPXMMR1M\_WE, CPXMMR1M\_GY,  
CPXDNDIN1M\_WE, CPXMMRIN1M\_WE

Please contact Customer Care Center for Stockable and Non stockable status of references.

☑ NORMAL STOCK ITEMS

W.E.F. January 17<sup>th</sup>, 2024

# Opale - Switches with Satin Finish

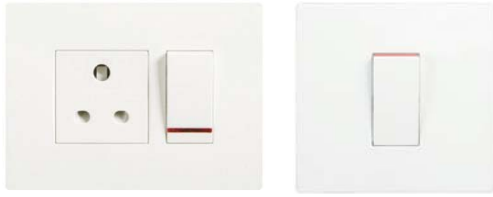

- **Patented Smooth Satin Finish** - Scratch Resistant, Easy to Clean & Prevents light reflection off surface
- **Safe to Use** - High grade flame retardant polycarbonate material & Child Proof sockets with unique shutter design
- **Hassle Free Operation** - 'Soft sound' switches with Gold plated Data Socket contacts for better connection
- **Easy to Install** - Snap-In / Snap-Out front loading modules and terminals with indented screws
- **Green & Eco Friendly** - RoHS compliant range



X1001WH



X1286WH



X1186WH



X1005WH



X1085WH



X2005WHNS



X2106WH



X4020WH



X3200WH



X3104WH



X4010WH



X7003WH



X5001



X5002

Description	Reference for White	Unit MRP [₹]	Pack	Reference for Coke Grey	Unit MRP [₹]	Pack
<b>Switches</b>						
6AX 1 way switch	X1001WH	234	20	AAKY1001	297	20
6AX 1 way switch with Indicator lamp	X1081WH	431	20	AAKY1081	510	20
6AX 2 way switch	X1002WH	322	20	AAKY1002	434	20
16AX 1 way switch	X1101WH	376	20	AAKY1101	471	20
16AX 1 way switch with Indicator lamp	X1181WH	527	20	AAKY1181	622	20
16AX 2 way switch	X1102WH	507	20	AAKY1102	694	20
16AX 1 way switch (2M)	X1121WH	572	10	-	-	-
6AX 1 way switch with Indicator (2M)	X1028WH	583	10	-	-	-
16AX 1 way switch with Indicator (2M)	X1128WH	715	10	-	-	-
20A DP switch with Indicator (2M)	X1286WH	871	10	AAKY1286	1199	10
32A DP switch (2M)	AAKX1232	1297	10	-	-	-
<b>Motor Starter Switch</b>						
25A Motor Starter switch	X1186WH	2,421	10	-	-	-
<b>Bell Push</b>						
6A Bell Push	X1005WH	364	20	AAKY1005	516	20
6A Bell Push (2M)	X1025WH	521	10	AAKY1025	733	10
6A Bell Push with Indicator	X1085WH	560	20	-	-	-
6A Bell Push with Indicator (2M)	X1086WH	637	10	-	-	-
<b>Sockets</b>						
6A 3-Pin Socket outlet with Shutter (BIS)	X2005WHNS	396	10	AAKY2005NS	478	10
6A/16A 3-Pin Socket Outlet with Shutter	X2106WH	606	10	AAKY2106	721	10
<b>Fan Regulators &amp; Dimmers</b>						
Step Fan Regulator (1M)	X3100WH	1015	10	AAKY3100	1327	10
Step type fan regulator (2M)	X3200WH	1422	5	AAKY3200	1701	5
Dimmer 400W (1M)	X3104WH	1273	10	AAKY3104	1769	10
Dimmer 400W (2M)	X3004WH	1981	5	-	-	-
<b>USB Chargers</b>						
2 Gang USB Charger - 2.1A (2M)	X7003WH	3,744	15	AAKY7003	4765	15
<b>Accessories</b>						
RJ11 Telephone outlet (no shutter)	X4010WH	328	10	-	-	-
RJ11 Telephone outlet with shutter	X4011WH	325	10	AAKY4011	463	10
Twin RJ11 Telephone outlets (no shutter) (1M)	X4020WH	530	10	-	-	-
RJ45 Data Outlet with shutter	X4045WH	1121	20	AAKY4045	1433	20
TV Socket	X4500WH	305	10	AAKY4500	441	10
RJ45 Cover for Key Stone Type	X4050WH	435	10	-	-	-
Gripped Cord Outlet	X4550WH	393	10	-	-	-
Buzzer	X3300WH	1488	2	AAKY3300	1779	2
Blank off unit (1M)	X0001WH	87	10	AAKY0001	123	20
Neon Phase Indicator (Red)	X5001	527	20	-	-	-
Neon Phase Indicator (Green)	X5002	609	20	-	-	-
Neon Phase Indicator (Yellow)	X5003	609	20	-	-	-

Please contact Customer Care Center for Stockable and Non stockable status of references.

✓ NORMAL STOCK ITEMS

W.E.F. January 17<sup>th</sup>, 2024

# Opale - Switches with Satin Finish



AAKX6002 + AAKX6004 + X0702



AAKX6006 + X0703



AAKX6005

Description	Reference	Unit MRP [₹]	Pack
<b>Hotel Series*</b>			
DND Panel	AAKX6001	947	20
DND Switch	AAKX6002	738	20
MMR Panel	AAKX6003	894	20
MMR Switch	AAKX6004	738	20
Key Tag Switch (Mechanical Type 20 A)	AAKX6005	1779	1
Shaver Socket	AAKX6006	7851	1

\*Available in white colour only



X0733WH



X0703



AAKY0804

Description	Reference for White	Unit MRP [₹]	Pack	Reference for Coke Grey	Unit MRP [₹]	Pack
<b>Cover Plates</b>						
1-2 M Grid & 1 M Cover Frame	X0701	213	10	AAKY0801	281	10
1-2 M Grid & 2 M Cover Frame	X0702	226	10	AAKY0802	296	10
3 M Grid & 3 M Cover Frame	X0703	267	10	AAKY0803	325	10
3 M Universal Grid & 3 M Cover Frame	X0733WH	383	10	-	#N/A	-
4 M Grid & 4 M Cover Frame	X0704	313	10	AAKY0804	418	10
6 M Grid & 6 M Cover Frame	X0706	436	5	AAKY0806	517	5
8 M Grid & 8 M Cover Frame - Horizontal	X0708	568	5	AAKY0808	674	5
8 M Grid & 8 M Cover Frame - Square	X0709	671	5	AAKY0809	1014	5
12 M Grid & 12 M Cover Frame	X0712	789	5	AAKY0812	1189	5
18 M Grid & 18 M Cover Frame	AAKX0718	1028	5	-	-	-

Please contact Customer Care Center for Stockable and Non stockable status of references.

NORMAL STOCK ITEMS

W.E.F. January 17<sup>th</sup>, 2024

# Unica Pure - Irresistibly Beautiful



Wood



Glass

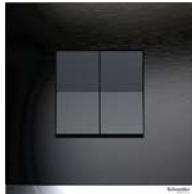

Metal Rhodium Black



Sandy Beige

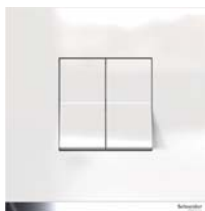

Polar White

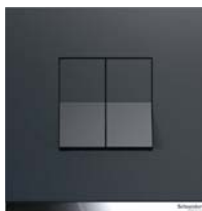

Volcanic Grey



Pearl Black



Pewter Grey



Oak

## Irresistibly Beautiful

- Authentic finishes - developed from the high quality natural material
- Ingenious Design - Demarcated dolly depicting clear on/off mode of the switch
- Modish Colors - perfectly gel with neutral, accent wall colors and blends perfectly with any decor

## Irresistibly Safe & Sturdy

- Self Piercing Terminal - ensuring completely safe, robust and fast installation
- Facile & Guarded Technology - reduces tension in the switch rocker & increases the longevity of the switch
- Plated metal with Plastic over molded Gridplate - Robust, rigid & shock proof gridplate, ensuring durable installation on the metal box

## Irresistibly Easy

- Key Hole Feature - Angular and linear adjustments of the gridplate can be easily achieved
- Revolutionary Ease of Mounting with Indicators & Markings

## Irresistibly Sustainable

- Green Premium - Complies to HIGHEST INTERNATIONAL STANDARD of Green
- Certification for manufactured products (RoHS, REACH, PEP, EoLI) and is 100% Recyclable

## Irresistibly Innovative

- Future Ready - Features of Voice & Mobile control to fit with smart homes

## Irresistibly Versatile

- One Stop Shop - Extensive range covering residential, office, commercial or hospitality
- **Intermediate switches to control multiple 2way switches**

## Unica Pure switches with six patented technologies



### Life Guarded Sockets

Eliminate possibility of Single Pin Insertion making it extra safe for children

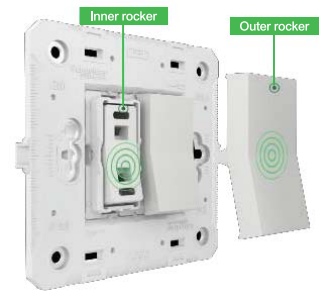

### Facile & Guarded Technology

Reduces tension in the switch rocker & increases the longevity of the switch

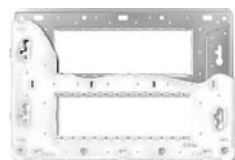

### Key Hole Feature

Angular and linear adjustments of the gridplate can be easily achieved



### Adjoining (V) Feature Technology

Ensuring perfect alignment of switches



### Self-piercing Terminal

Ensuring completely safe, robust and fast installation

Please contact Customer Care Center for Stockable and Non stockable status of references.

☑ NORMAL STOCK ITEMS

W.E.F. January 17<sup>th</sup>, 2024

# Unica Pure - Irresistibly Beautiful



UNS61SW1M\_WE



UNS161SWL1M\_WE



UNS162MSWL1M\_WE



UNS10SW1M\_WE



UNS6SK3P2MNS\_WE



UNS616SK2M\_WE



UNS162SW2M\_WE



UNSMTSTART2M\_WE



UNS21USB2P2M\_WE



UNS21USB1P1M\_WE



UNS5STFAN2M\_WE



UNSACUSB1P1M\_WE



UNSHDMI\_WE



UNSCPTVDIG1M\_WE



UNSSKTLT2M\_WE

Description	Reference for Polar White	Unit MRP [₹]	Pack	Reference for Volcanic Grey	Unit MRP [₹]	Pack
<b>6A Switches</b>						
6AX 1 Way Switch	UNS61SW1M_WE	220	20	UNS61SW1M_GY	253	20
6AX 1 Way Switch With Indicator	UNS61SWL1M_WE	392	20	UNS61SWL1M_GY	449	20
6AX 2 Way Switch	UNS62SW1M_WE	314	10	UNS62SW1M_GY	351	10
<b>6A Intermediate Switches</b>						
10AX Intermediate Switch	UNS10SW1M_WE	1,404	1	UNS10SW1M_GY	1,693	1
<b>16AX Switches</b>						
16AX 1 Way Switch	UNS161SW1M_WE	367	20	UNS161SW1M_GY	428	20
16AX 1 Way Switch With Indicator	UNS161SWL1M_WE	439	20	UNS161SWL1M_GY	511	20
16AX 2 Way Switch, Polar White	UNS162SW1M_WE	486	10	UNS162SW1M_GY	572	10
16A Master Switch, 2 Way, With Locator & Label	UNS162MSWL1M_WE	1,122	20	UNS162MSWL1M_GY	1,326	1
16Ax 2 Way 2M Switch	UNS162SW2M_WE	486	10	UNS162SW2M_GY	578	10
16AX~20A 1Way switch with Neon indicator	UNS201SWL1M_WE	426	10	UNS201SWL1M_GY	504	10
<b>Double Pole Switches</b>						
20A Double Pole Switch With Indicator	UNS20DP2M_WE	868	10	UNS20DP2M_GY	1022	1
32A Double Pole Switch With Indicator	UNS32DP2M_WE	1328	10	UNS32DP2M_GY	1583	10
<b>Motor Starter Switch</b>						
Motor Starter	UNSMSTART2M_WE	1,978	10	UNSMSTART2M_GY	2,340	10
<b>Bell Switches</b>						
6A Bellpress, 1M	UNS6BP1M_WE	325	20	UNS6BP1M_GY	381	20
6A Bellpress With Indicator, 1M	UNS6BPL1M_WE	450	20	UNS6BPL1M_GY	536	1
6A Bellpress, 2M, Polar White	UNS6BP2M_WE	447	10	UNS6BP2M_GY	525	1
6A Bellpress With Indicator, 2M	UNS6BPL2M_WE	551	10	UNS6BPL2M_GY	647	1
<b>6A Sockets</b>						
6A 3PIN Sockets outlet with Shutter (BIS)	UNS6SK3P2MNS_WE	464	10	UNS6SK3P2MNS_GY	511	10
<b>6/16A Sockets</b>						
6/16A Socket	UNS616SK2M_WE	543	10	UNS616SK2M_GY	675	10
<b>USB Chargers</b>						
2.1A 5V USB Charger, 2 Module	UNS21USB2P2M_WE	3,295	10	UNS21USB2P2M_GY	3894	1
2.1A 5V USB Charger, 1 Module	UNS21USB1P1M_WE	2,276	20	UNS21USB1P1M_GY	2699	20
2.4A 5V A+C USB Charger, 1 Module	UNSACUSB1P1M_WE	3,512	10	UNSACUSB1P1M_GY	3949	10
<b>Blank Plates</b>						
Single Module Blank Plate	UNSBANK1M_WE	79	20	UNSBANK1M_GY	88	20
<b>Fan Regulators</b>						
4 Steps 360 Deg Fan Regulator, 1M	UNS4STFAN1M_WE	952	20	UNS4STFAN1M_GY	1103	20
5 Steps 360 Deg Fan Regulator, 2M	UNS5STFAN2M_WE	1509	10	UNS5STFAN2M_GY	1703	10
<b>Emergency Light Indicator</b>						
Emergency Light Module*	UNSEMERGENCY2M_WE	10883	1	-	-	-
<b>Network, Connectivity &amp; Media Series</b>						
RJ 11 (WITH Shutter)	UNSRJ11_1M_WE	302	20	UNSRJ11_1M_GY	355	20
RJ 45 (WITH Shutter), Cat 6	UNSRJ45_1M_WE	1103	20	UNSRJ45_1M_GY	1277	20
TV Socket Coaxial	UNSTVCOAX1M_WE	312	20	UNSTVCOAX1M_GY	372	20
Volume Control	UNSVOLCTRL2M_WE	2460	10	UNSVOLCTRL2M_GY	2933	10
HDMI	UNSHDMI_WE	2097	20	UNSHDMI_GY	2365	20
TV Socket Digital (F-Connector)	UNSCPTVDIG1M_WE	354	1	-	-	-
Shaver Socket	UNSSHAYER_WE	8079	1	UNSSHAYER_GY	8811	1
PIR Motion Sensor*	UNSPIR_WE	10302	4	-	-	-

Please contact Customer Care Center for Stockable and Non stockable status of references.

NORMAL STOCK ITEMS

W.E.F. January 17<sup>th</sup>, 2024

# Unica Pure - Irresistibly Beautiful



UNSEKCSW\_WE



UNSCURTAINSW2M\_WE



UNSSHAVER\_WE



UNSPIR\_WE



UNSPHASEG1M



UNSPHASER1M

Description	Reference for Polar White	Unit MRP [₹]	Pack	Reference for Volcanic Grey	Unit MRP [₹]	Pack
<b>Hotel Series*</b>						
Skirt Light with LED, 2M	UNSSKTLT2M_WE	1,377	10	UNSSKTLT2M_GY	1,612	10
Buzzer	UNSBUZZER1M_WE	2,160	10	UNSBUZZER1M_GY	2,368	10
Cord Outlet	UNSCORD1M_WE	400	20	UNSCORD1M_GY	445	20
DND / MMR Indicator*	UNSDM1M	1,458	20	-	-	-
DND/MMR Indicator v.2	UNSDM1M_WE	1,719		UNSDM1M_GY	1,964	
DND Switch	UNSDNDSW1M_WE	581	10	UNSDNDSW1M_GY	709	10
MMR Switch	UNSMMSW1M_WE	581	10	UNSMMSW1M_GY	709	10
Electronic Keycard Switch, White	UNSEKCSW_WE	7,792	5	UNSEKCSW_GY	9,007	5
Electronic Keycard Switch, Sandy Beige	UNSEKCSW_CL	7,946	5	UNSEKCSW_CD	7,839	5
Curtain Control Switch	UNSCURTAINSW2M_WE	1,021	10	UNSCURTAINSW2M_GY	1,184	10

Description	Reference	Unit MRP [₹]	Pack
<b>LED Phase Indicator</b>			
LED Phase Indicator, Red	UNSPHASER1M	508	20
LED Phase Indicator, Green	UNSPHASEG1M	508	20
LED Phase Indicator, Yellow	UNSPHASEY1M	508	20

Please contact Customer Care Center for Stockable and Non stockable status of references.

NORMAL STOCK ITEMS

W.E.F. January 17<sup>th</sup>, 2024

# Unica Pure - Irresistibly Beautiful



UNPGP2M



UNPGP6M

Description	Reference for Gridplate	Unit MRP [₹]	Pack
<b>Cover Plates</b>			
2Module Gridplate (Fixing Frame) Only	UNPGP2M	175	4
3Module Gridplate (Fixing Frame) Only	UNPGP3M	214	9
4Module Gridplate (Fixing Frame) Only	UNPGP4M	246	8
6Module Gridplate (Fixing Frame) Only	UNPGP6M	334	9
8M Gridplate (Fixing Frame) Only, Linear	UNPGP8ML	345	9
8M Gridplate (Fixing Frame) Only, Square	UNPGP8MSQ	442	6
12Module Gridplate (Fixing Frame) Only	UNPGP12M	515	6



UNPSP2M\_WD



UNPSP6M\_WD

Description	Reference for Oak Wood	Unit MRP [₹]	Pack
<b>Cover Plates</b>			
1 Module Wood Cover Frame Only	UNPSP1M_WD	2,478	6
2 Module Wood Cover Frame Only	UNPSP2M_WD	2,634	6
3 Module Wood Cover Frame Only	UNPSP3M_WD	3,260	6
4 Module Wood Cover Frame Only	UNPSP4M_WD	3,772	6
6 Module Wood Cover Frame Only	UNPSP6M_WD	5,383	3
8 Module Wood Cover Frame Only, Linear	UNPSP8ML_WD	6,541	3
8 Module Wood Cover Frame Only, Square	UNPSP8MSQ_WD	7,803	6
12 Module Wood Cover Frame Only	UNPSP12M_WD	10,433	6



UNPSP2M\_GW



UNPSP6M\_GW

Description	Reference for Aqua Glass	Unit MRP [₹]	Pack
<b>Cover Plates</b>			
1Module Aqua Glass Cover Frame Only	UNPSP1M_GW	1,377	6
2Module Aqua Glass Cover Frame Only	UNPSP2M_GW	1,549	6
3Module Aqua Glass Cover Frame Only	UNPSP3M_GW	1,744	6
4Module Aqua Glass Cover Frame Only	UNPSP4M_GW	1,822	6
6Module Aqua Glass Cover Frame Only	UNPSP6M_GW	3,292	3
8M Aqua Glass Cover Frame Only, Linear	UNPSP8ML_GW	3,741	3
8M Aqua Glass Cover Frame Only, Square	UNPSP8MSQ_GW	4,738	6
12Module Aqua Glass Cover Frame Only	UNPSP12M_GW	5,876	6

Please contact Customer Care Center for Stockable and Non stockable status of references.

NORMAL STOCK ITEMS

W.E.F. January 17<sup>th</sup>, 2024



# Unica Pure - Irresistibly Beautiful



UNPSP2M\_GB



UNPSP6M\_GB

Description	Reference for Pearl Black Glass	Unit MRP [₹]	Pack
<b>Cover Plates</b>			
1M Pearl Black Glass Cover Frame Only	UNPSP1M_GB	1,630	6
2M Pearl Black Glass Cover Frame Only	UNPSP2M_GB	1,833	6
3M Pearl Black Glass Cover Frame Only	UNPSP3M_GB	1,993	6
4M Pearl Black Glass Cover Frame Only	UNPSP4M_GB	2,160	6
6M Pearl Black Glass Cover Frame Only	UNPSP6M_GB	3,883	3
8M Pearl Black Glass CF Only, Linear	UNPSP8ML_GB	4,407	3
8M Pearl Black Glass CF Only, Suare	UNPSP8MSQ_GB	5,584	6
12M Pearl Black Glass Cover Frame Only	UNPSP12M_GB	6,915	6



UNPSP2M\_ML



UNPSP6M\_ML

Description	Reference for Pewter Grey Metal	Unit MRP [₹]	Pack
<b>Cover Plates</b>			
1 Module Pw Grey Metal Cover Frame Only	UNPSP1M_ML	2,448	6
2 Module Pw Grey Metal Cover Frame Only	UNPSP2M_ML	2,717	6
3 Module Pw Grey Metal Cover Frame Only	UNPSP3M_ML	3,092	6
4 Module Pw Grey Metal Cover Frame Only	UNPSP4M_ML	3,251	6
6 Module Pw Grey Metal Cover Frame Only	UNPSP6M_ML	5,757	3
8Module Pw Grey Metal CF Only, Linear	UNPSP8ML_ML	6,486	3
8 Module Pw Grey Metal CF Only, Suare	UNPSP8MSQ_ML	8,238	6
12Module Pw Grey Metal Cover Frame Only	UNPSP12M_ML	10,219	6

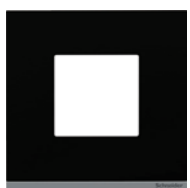

UNPSP2M\_MD



UNPSP6M\_MD

Description	Reference for Black Metal	Unit MRP [₹]	Pack
<b>Cover Plates</b>			
1Module Rh Black Metal Cover Frame Only	UNPSP1M_MD	2,448	6
2Module Rh Black Metal Cover Frame Only	UNPSP2M_MD	2,717	6
3Module Rh Black Metal Cover Frame Only	UNPSP3M_MD	3,092	6
4Module Rh Black Metal Cover Frame Only	UNPSP4M_MD	3,251	6
6Module Rh Black Metal Cover Frame Only	UNPSP6M_MD	5,757	3
8Module Rh Black Metal CF Only, Linear	UNPSP8ML_MD	6,486	3
8 Module Rh Black Metal CF Only, Suare	UNPSP8MSQ_MD	8,238	6
12M Rh Black Metal Cover Frame Only	UNPSP12M_MD	10,219	6

Please contact Customer Care Center for Stockable and Non stockable status of references.

NORMAL STOCK ITEMS

W.E.F. January 17<sup>th</sup>, 2024

# Unica Pure - Irresistibly Beautiful



Description	Reference for Painted Sandy Biege	Unit MRP [₹]	Pack	Reference for Painted Mocha Brown	Unit MRP [₹]	Pack	Reference for Molded Polar White	Unit MRP [₹]	Pack	Reference for Molded Volcanic Grey	Unit MRP [₹]	Pack
<b>Cover Plates</b>												
1 Module Plastic Surround and Gridplate	UNSCP1M_CL	477	20	UNSCP1M_CD	468	20	UNSCP1M_WE	245	20	UNSCP1M_GY	348	20
2 Module Plastic Surround and Gridplate	UNSCP2M_CL	541	20	UNSCP2M_CD	522	20	UNSCP2M_WE	273	20	UNSCP2M_GY	389	20
3 Module Plastic Surround and Gridplate	UNSCP3M_CL	607	10	UNSCP3M_CD	609	10	UNSCP3M_WE	312	10	UNSCP3M_GY	444	10
4 Module Plastic Surround and Gridplate	UNSCP4M_CL	636	14	UNSCP4M_CD	636	14	UNSCP4M_WE	329	14	UNSCP4M_GY	474	14
6 Module Plastic Surround and Gridplate	UNSCP6M_CL	1,133	5	UNSCP6M_CD	1095	5	UNSCP6M_WE	574	5	UNSCP6M_GY	818	5
8 Module Plastic Surround and Gridplate, Linear	UNSCP8ML_CL	1,258	5	UNSCP8ML_CD	1235	5	UNSCP8ML_WE	646	5	UNSCP8ML_GY	914	5
8 Module Plastic Surround and Gridplate, Square	UNSCP8MSQ_CL	1,563	10	UNSCP8MSQ_CD	1563	10	UNSCP8MSQ_WE	835	10	UNSCP8MSQ_GY	1266	10
9 Module Plastic Surround and Gridplate	-	-	-	-	-	-	UNSCP9M_WE	1043	5	UNSCP9M_GY	1629	5
12 Module Plastic Surround and Gridplate	UNSCP12M_CL	1,954	5	UNSCP12M_CD	1,957	5	UNSCP12M_WE	1156	5	UNSCP12M_GY	2033	5
16 Module Plastic Surround and Gridplate	UNSCP16M_CL	2,649	5	UNSCP16M_CD	2,649	5	UNSCP16M_WE	1423	5	UNSCP16M_GY	2455	5
18 Module Plastic Surround and Gridplate	UNSCP18M_CL	2,838	1	UNSCP18M_CD	2,838	1	UNSCP18M_WE	1475	1	UNSCP18M_GY	2621	1

Please contact Customer Care Center for Stockable and Non stockable status of references.

NORMAL STOCK ITEMS

W.E.F. January 17<sup>th</sup>, 2024

# Wiring Diagram Unica Pure

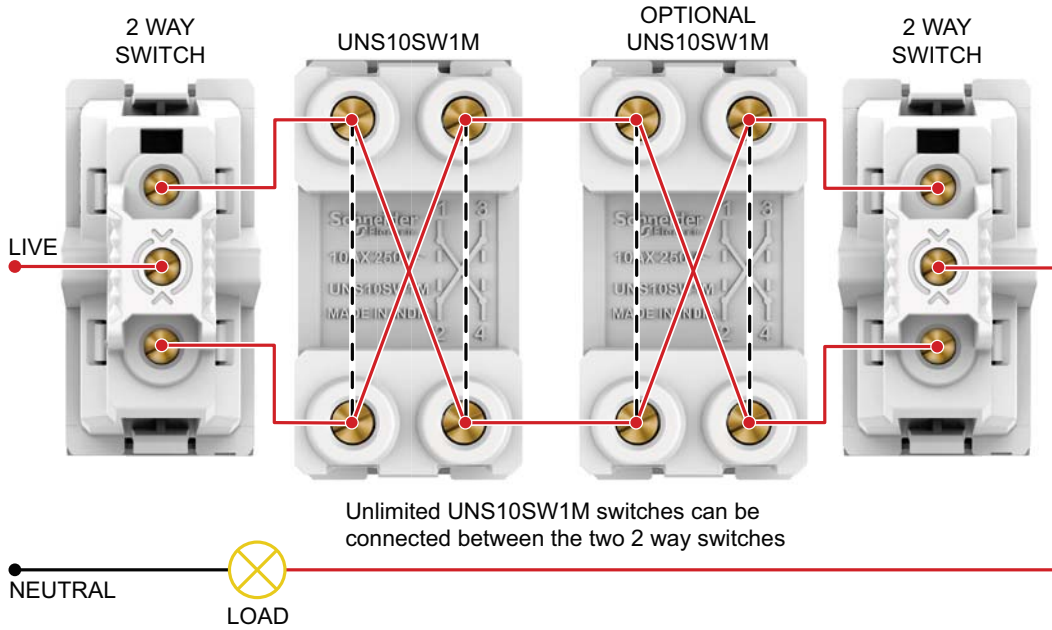

> 10AX Intermediate Switch  
UNS10SW1M\_WE, UNS10SW1M\_GY

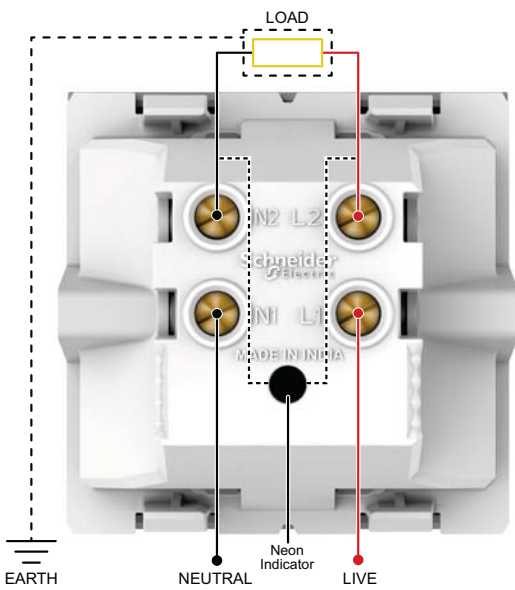

> 20A Double Pole Switch With Indicator  
UNS20DP2M\_WE, UNS20DP2M\_GY

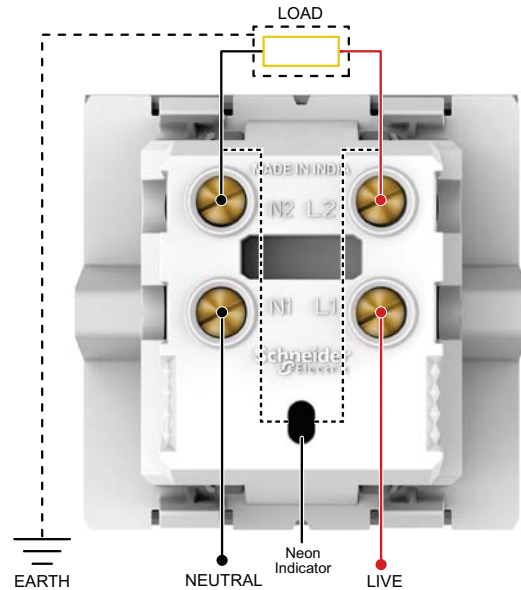

> 32A Double Pole Switch With Indicator  
UNS32DP2M\_WE, UNS32DP2M\_GY

Please contact Customer Care Center for Stockable and Non stockable status of references.

☑ NORMAL STOCK ITEMS

W.E.F. January 17<sup>th</sup>, 2024

# Wiring Diagram Unica Pure

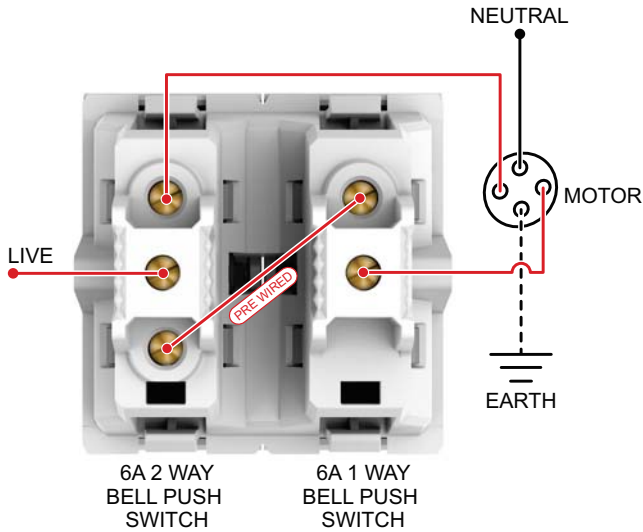

> **Curtain Control Switch**  
UNSCURTAINSW2M\_WE

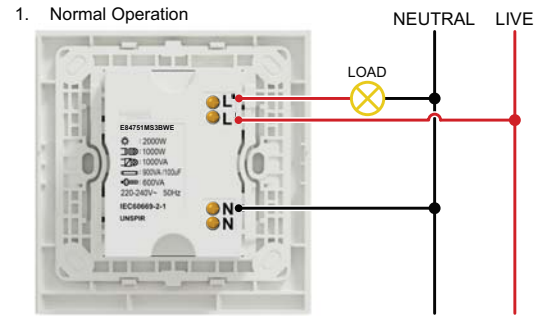

> **PIR Motion Sensor\***  
UNSPIR\_WE

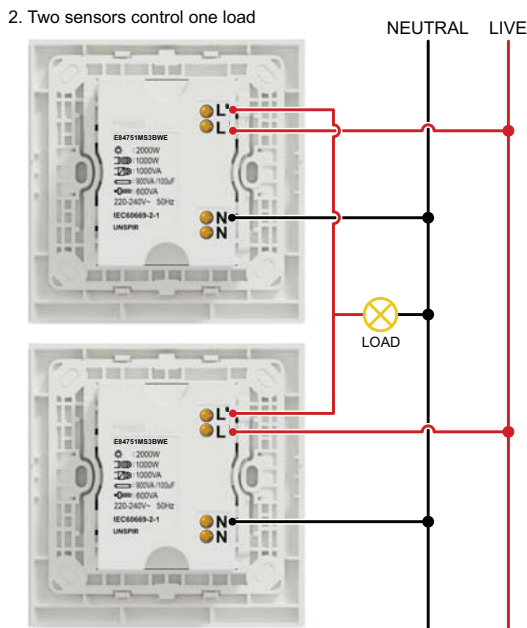

> **PIR Motion Sensor\***  
UNSPIR\_WE

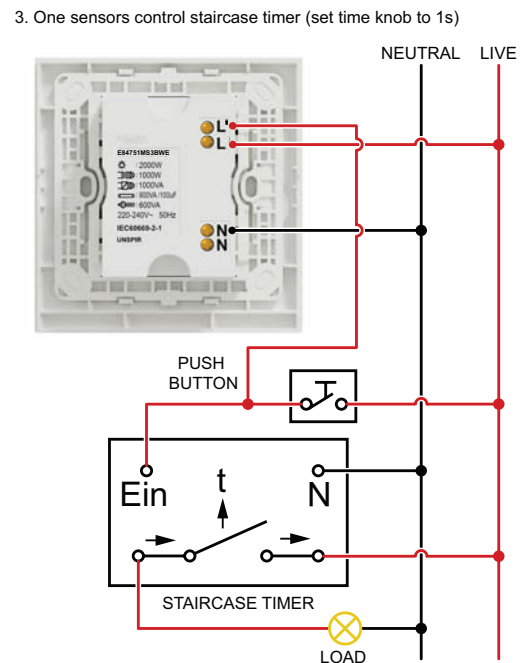

> **PIR Motion Sensor\***  
UNSPIR\_WE

Please contact Customer Care Center for Stockable and Non stockable status of references.

☑ NORMAL STOCK ITEMS

W.E.F. January 17<sup>th</sup>, 2024

# Wiring Diagram Unica Pure

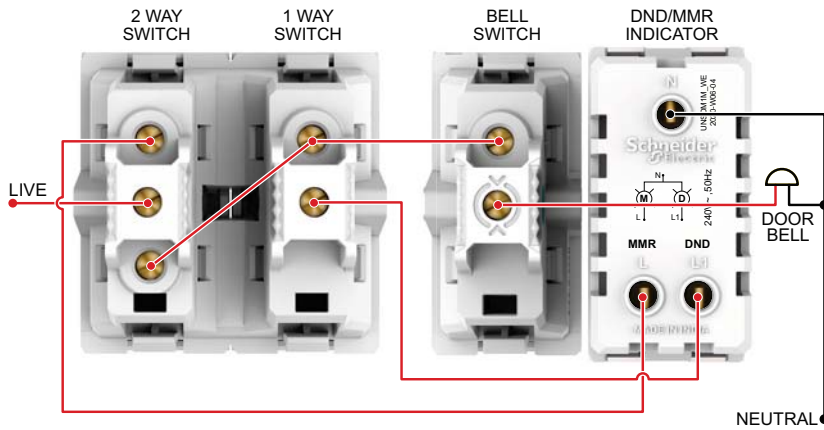

> DND/MMR Indicator v.2 > Do Not Disturb Switch  
 > Make My Room Switch > DND Switch  
 > MMR Switch

UNSDM1M\_WE, UNSDM1M\_GY, UNSDNDSW1M\_WE,  
 UNSDNDSW1M\_GY, UNSMMRSW1M\_WE, UNSMMRSW1M\_GY

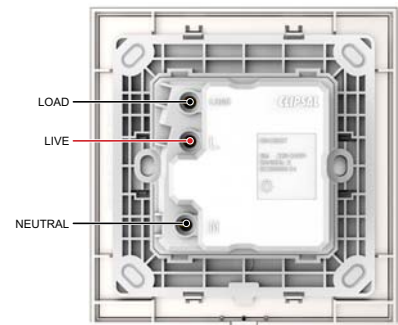

> Unica Pure Key Card

UNSEKCSW\_WE, UNSEKCSW\_GY,  
 UNSEKCSW\_CL, UNSEKCSW\_CD

Please contact Customer Care Center for Stockable and Non stockable status of references.

NORMAL STOCK ITEMS

W.E.F. January 17<sup>th</sup>, 2024

# ZENcelo India - The Revolutionary Full-Flat Switch



- **World's First and only Full-Flat Mechanical Switch**
- **Patented Iso-Motion Technology** - Ensures switch stays in the same position whether On or Off
- **Robust & Strong** - Made of corrosion-resistant, heat-resistant and impact-resistant polycarbonate
- **Safe to Use** - Electric arc encapsulated switches and Data Sockets with patented integrated shutter
- **Designed to Last** - Switches tested to 80,000 times; Sockets tested to 15,000 cycles.
- **Green & Eco Friendly** - RoHS compliant range
- **Dust Proof Cover**
- **All Dark Grey references covered with electrostatic protective film**
- **Intermediate switches to control multiple 2way switches**
- **16AX~20A 1 Way 2G Switch (1M) - IN8444/16: Single: switch to control two loads**



Description	Reference for White	Unit MRP [₹]	Pack	Reference for Dark Grey	Unit MRP [₹]	Pack
<b>Switches</b>						
6AX 1 Way switch	IN8401	408	10	IN8401(BZ)	511	10
6AX 1 Way switch (2M)	IN8421	718	10	IN8421(BZ)	866	10
6AX 2 Way switch	IN8402	511	10	IN8402(BZ)	613	10
6AX 1 Way switch with Neon	IN8481	642	10	IN8481(BZ)	769	10
16AX~20A 1 Way switch	IN8401/16	616	10	IN8401/16(BZ)	750	10
16AX~20A 1 Way switch (2M)	IN8421/16	958	10	-	-	-
16AX~20A 1 Way switch with Neon	IN8481/16	876	10	IN8481/16(BZ)	1038	10
16AX~20A 1 Way switch with Neon (2M)	IN8482/16	1132	10	IN8482/16(BZ)	1333	10
16AX~20A 2 Way switch	IN8402/16	867	10	IN8402/16(BZ)	1124	10
16AX~20A 2 Way switch (2M)	IN8422/16	1038	10	IN8422/16(BZ)	1339	10
16AX~20A 1 Way 2G switch (1M)	IN8444/16	1008	10	IN8444/16(BZ)	1215	10
10AX Intermediate switch	IN8430/IM	1596	10	IN8430/IM(BZ)	1804	1
20A DP Switch with Neon (2M)	IN8486/20	1337	5	IN8486/20(BZ)	1750	5
32A DP Switch with Neon (2M)	IN8486/32	2100	5	IN8486/32(BZ)	2523	5
<b>Motor Starter Switch</b>						
25A Motor Starter switch (2M)	IN8425MS	3438	10	IN8425MS(BZ)	3658	10
<b>Bell Push</b>						
6A Bell Push switch	IN8405	579	10	IN8405(BZ)	699	10
6A Bell Push switch (2M)	IN8425	936	10	IN8425(BZ)	1109	10
6A Bell Push switch with Neon	IN8485	834	10	IN8485(BZ)	983	10
6A Bell Push switch with Neon (2M)	IN8486	989	10	IN8486(BZ)	1220	10
6A Momentary Switch, WH	IN8487	774	10	IN8487_BZ	914	10
<b>Sockets</b>						
6A 3PIN Socket Outlet with Shutter (BIS)	IN8426UNS	667	10	IN8426UNS_BZ	807	10
6A/16A 3 Pin Socket with Shutter	IN8426/16	992	10	IN8426/16(BZ)	1215	10
<b>Fan Regulators &amp; Dimmers</b>						
Fan Control (5 Speeds)	IN84SFR	2359	5	IN84SFR(BZ)	2831	5
Full Flat 500W Dimmer Module (1 Gang)	IN8404D	2143	10	IN8404D(BZ)	2539	10
<b>USB Chargers</b>						
1 Gang USB Charger - 2.1A (1M)	IN8431USB_WE	3826	10	IN8431USB_BZ	4389	10
2.4A 5V A+C USB Charger (1M)	IN8431ACUSB_WE	4228	10	IN8431ACUSB_BZ	4846	10
<b>Accessories</b>						
RJ11 Telephone Outlet with shutter (1 Gang)	IN8431RJS4	638	10	IN8431RJS4(BZ)	786	10
RJ45 Cat6 Data Outlet with shutter	IN8431RJ6	2240	10	IN8431RJ6(BZ)	2736	10
Data Outlet Wall Plate (for RJ45 key stone jack)	IN8431RJC	826	10	IN8431RJC(BZ)	971	10
TV Socket	IN8431TV	487	10	IN8431TV(BZ)	616	10
Cord Outlet	IN8445CO	615	10	-	-	-
Foot Lamp with White LED (2M)	IN8490FLW	4501	10	-	-	-
Foot Lamp with Yellow LED (2M)	IN8490FLY	4389	10	-	-	-
Blank off unit (1M)	IN8430X	149	10	IN8430X(BZ)	183	10
<b>Hotel Series</b>						
Do Not Disturb Panel	INH8451	3416	10	INH8451(BZ)	3825	10
Make My Room Panel	INH8454	3105	10	INH8454(BZ)	3465	10
Do Not Disturb Switch	INH8452	1696	10	INH8452(BZ)	1855	10
Do Not Disturb Switch (2M)	-	-	-	INH8453(BZ)	2041	10
Make My Room Switch	INH8455	1657	10	INH8455(BZ)	1955	10

Please contact Customer Care Center for Stockable and Non stockable status of references.

NORMAL STOCK ITEMS

W.E.F. January 17<sup>th</sup>, 2024

# ZENcelo India - The Revolutionary Full-Flat Switch

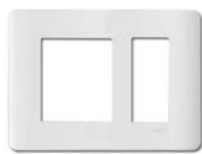

IN8403C

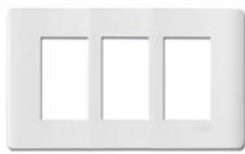

IN8406C



IN8402C(BZ)



IN8404C(SZ)

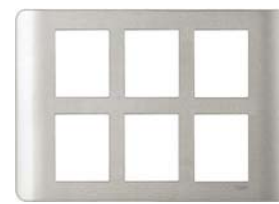

IN84012C(SA)

Description	Reference for White	Unit MRP [₹]	Pack	Reference for Dark Grey	Unit MRP [₹]	Pack	Reference for Silver Bronze	Unit MRP [₹]	Pack	Reference for Satin Silver	Unit MRP [₹]	Pack
<b>Cover Plates</b>												
1M Grid & 1M Cover Frame	IN8401C	383	10	IN8401C(BZ)	453	10	IN8401C(SZ)	1063	10	IN8401C(SA)	1166	10
2M Grid & 2M Cover Frame	IN8402C	397	10	IN8402C(BZ)	474	10	IN8402C(SZ)	1052	10	IN8402C(SA)	1154	10
3M Grid & 3M Cover Frame	IN8403C	468	10	IN8403C(BZ)	560	10	IN8403C(SZ)	1293	10	IN8403C(SA)	1418	10
4M Grid & 4M Cover Frame	IN8404C	510	10	IN8404C(BZ)	657	10	IN8404C(SZ)	1553	10	IN8404C(SA)	1705	10
6M Grid & 6M Cover Frame	IN8406C	778	5	IN8406C(BZ)	925	5	IN8406C(SZ)	2133	5	IN8406C(SA)	2340	5
8M Grid & 8M Cover Frame - Horizontal	IN8408HC	925	5	IN8408HC(BZ)	1106	5	IN8408HC(SZ)	2882	5	IN8408HC(SA)	3163	5
8M Grid & 8M Cover Frame - Square	IN8408SC	1234	5	IN8408SC(BZ)	1705	5	IN8408SC(SZ)	3500	5	IN8408SC(SA)	3840	5
9M Grid & 9M Cover Frame	IN8409C	1682	5	IN8409C(BZ)	2103	5	IN8409C(SZ)	4838	5	-	-	-
12M Grid & 12M Cover Frame	IN84012C	2028	5	IN84012C(BZ)	2495	5	IN84012C(SZ)	6446	5	IN84012C(SA)	7075	5
18M Grid & 18M Cover Frame	IN84018C	2860	5	IN84018C(BZ)	3693	5	IN84018C(SZ)	8533	5	IN84018C(SA)	9365	5

# ZENcelo - The Revolutionary Full-Flat Switch



E8431EKT-OS



E8431BPDM>SZ-OS



E84T727H-OS



E84T727V>SZ-OS

Description	Reference for White	Unit MRP [₹]	Pack	Reference For Silver Bronze	Unit MRP [₹]	Pack
<b>Hotel Series</b>						
"Please Clean Up" Symbols	E8431BPDM-OS	6,727		E8431BPDM>SZ-OS	8,392	1
16A Electronic Key Card Time Delay Switch	E8431EKT-OS	13,441		E8431EKT>SZ-OS	16,803	1
Universal Shaver Unit, Vertical	E84T727V-OS	7,604		E84T727V>SZ-OS	9,472	1
Universal Shaver Unit, Horizontal	E84T727H-OS	7,604		E84T727H>SZ-OS	9,472	1

Please contact Customer Care Center for Stockable and Non stockable status of references.

NORMAL STOCK ITEMS

W.E.F. January 17<sup>th</sup>, 2024

# Wiring Diagram ZENcelo

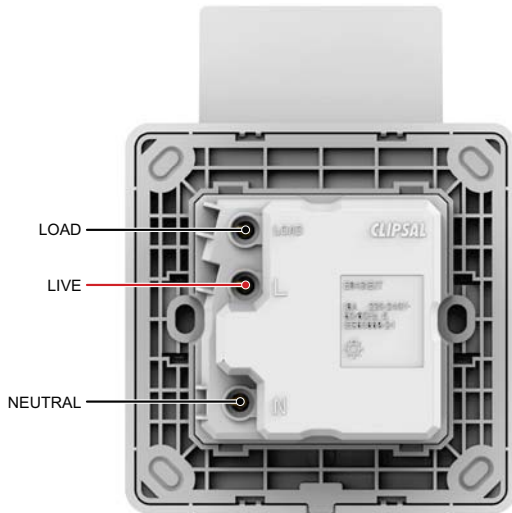

> 16A Electronic Key Card Time Delay  
E8431EKT-OS, E8431EKT>SZ-OS

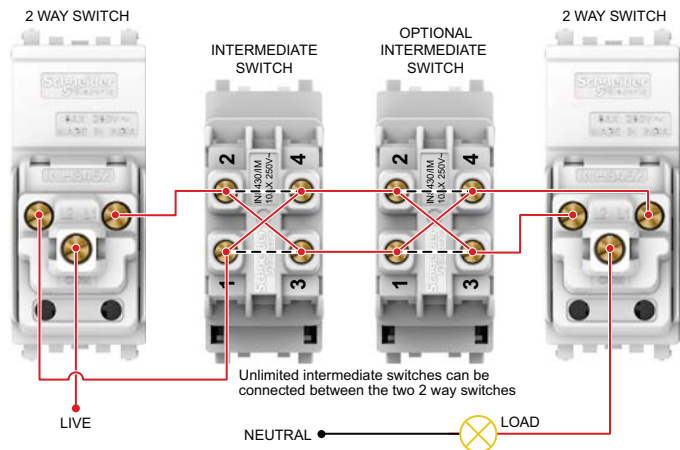

> 10AX Intermediate Switch  
IN8430/IM, IN8430/IM (BZ)

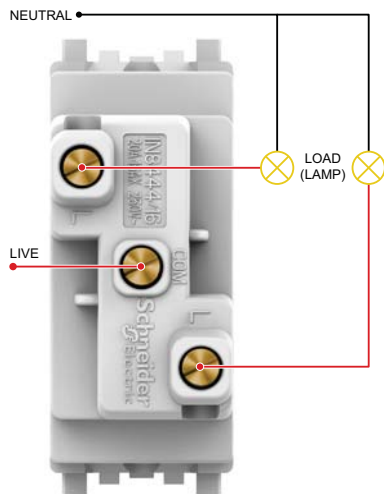

> 16AX~20A 1 Way 2G Switch (1M)  
IN8444/16, IN8444/16 (BZ)

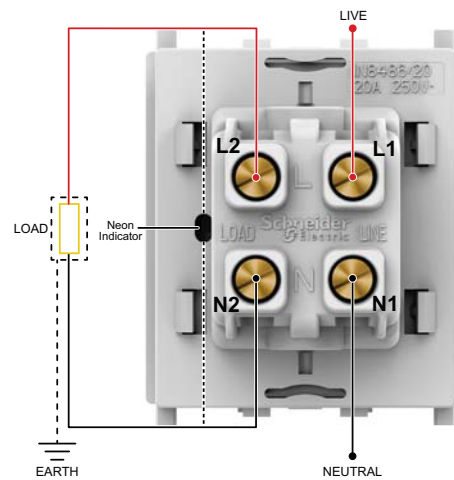

> 20A DP Switch with Neon (2M)  
IN8486/20, IN8486/20 (BZ)

Please contact Customer Care Center for Stockable and Non stockable status of references.

☑ NORMAL STOCK ITEMS

W.E.F. January 17<sup>th</sup>, 2024



# Wiring Diagram ZENcelo

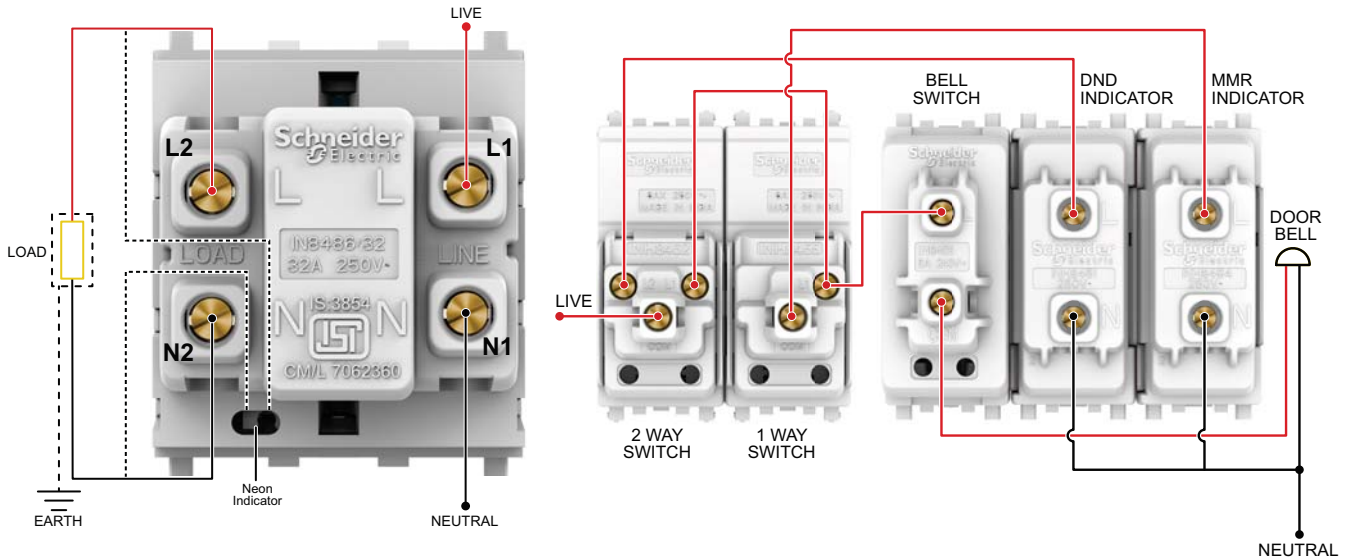

> 32A DP Switch with Neon (2M)

IN8486/32, IN8486/32 (BZ)

> Do Not Disturb Panel > Make My Room Panel  
> Do Not Distrub Switch > Make My Room Switch

INH8451, INH8451 (BZ), INH8454, INH8454 (BZ),  
INH8452, INH8452 (BZ), INH8455, INH8455 (BZ)

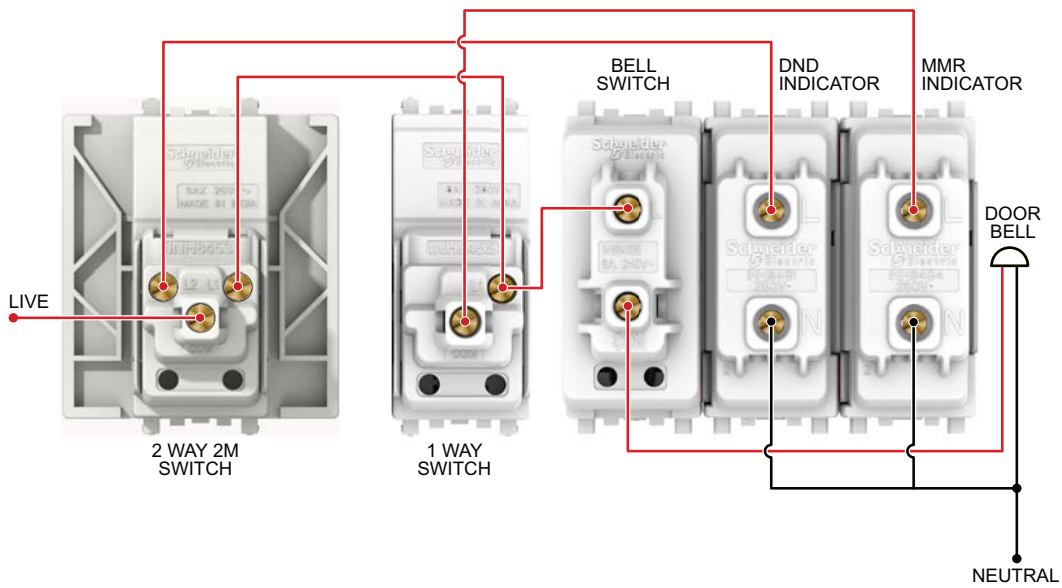

> Do Not Disturb Panel > Make My Room Panel  
> Do Not Disturb Switch (2M) > Make My Room Switch

INH8451, INH8451 (BZ), INH8454, INH8454 (BZ)  
INH8453 (BZ), INH8455, INH8455 (BZ)

Please contact Customer Care Center for Stockable and Non stockable status of references.

☑ NORMAL STOCK ITEMS

W.E.F. January 17<sup>th</sup>, 2024

# AvatarOn - It's also a Switch



White (WE)



Wine Gold (WG)



Dark Grey (DG)



Dark Wood (WD)



Gold Hairline (GH)



Light Wood (LW)



**Award-winning Designs:** In 2017, AvatarOn gained international recognition for its innovative design and quality excellence and was awarded the iF Design Award

### Ingenious Beauty

- The ground-breaking AvatarOn series is a true marriage of aesthetics and practicality, making it a perfect choice for all home or office designs.

### Safe and Reliable

- Our patented "Slim Rocker, Sure Click" SS technology not only gives AvatarOn a greater thinness overall, but also a near-zero contact jitter that reduces sparks, thus ensuring a safe and reliable use.

### Customisable Covers for True Adaptability

- AvatarOn switches are available in an array of replaceable covers for full customisation and integration into any home decor. The customised pattern covers of AvatarOn provides you with an extra canvas to showcase your creativity in a subtle yet apparent way.

### Modern Look

- The stylish and streamlined design of AvatarOn switch covers are finished in white, soft wood, dark wood and gold hairline materials for a classic look and universal elegance.

### Tech-chic Design that Shines

- The AvatarOn soft LED locators merges seamlessly with its sleek giant dolly, creating a stylish and streamlined design and glow with a soft luminescent in the dark, indicating the exact location of each switch at night.

### Multifunctional Accessories for Every Day Conveniences





















Product Description	Color	Product Ref. No.	Unit MRP [₹]	Pack
<b>16A Switches (Base + Cover Plate)</b>				
16AX 250V 1 Gang 1 Way Switch	White	E8331L1_WE_G8	588	1
	Wine Gold	E8331L1_WG_G8	884	10
	Dark Grey	E8331L1_DG_G8	884	1
	Metal Gold Hairline	E8331L1_GH_G8	884	10
	Light Wood	E8331L1_LW_G8	917	10
	Dark Wood	E8331L1_WD_G8	884	10
16AX 250V 1 Gang 1 Way Switch with LED Indicator	White	E8331L1LED_WE_G8	884	1
	Wine Gold	E8331L1LED_WG_G8	1322	10
	Dark Grey	E8331L1LED_DG_G8	1322	1
	Metal Gold Hairline	E8331L1LED_GH_G8	1322	10
16AX 250V 1 Gang 2 Way Switch	Light Wood	E8331L1LED_LW_G8	1496	10
	Dark Wood	E8331L1LED_WD_G8	1322	10
	White	E8331L2_WE_G8	629	1
	Wine Gold	E8331L2_WG_G8	943	10
16AX 250V 1 Gang 2 Way Switch with LED Indicator	Dark Grey	E8331L2_DG_G8	943	1
	Metal Gold Hairline	E8331L2_GH_G8	943	10
	Light Wood	E8331L2_LW_G8	979	10
	Dark Wood	E8331L2_WD_G8	943	10
	White	E8331L2LED_WE_G8	943	10
	Wine Gold	E8331L2LED_WG_G8	1416	10
16AX 250V 1 Gang 2 Way Switch with LED Indicator	Dark Grey	E8331L2LED_DG_G8	1416	1
	Metal Gold Hairline	E8331L2LED_GH_G8	1416	10
	Light Wood	E8331L2LED_LW_G8	1603	10
	Dark Wood	E8331L2LED_WD_G8	1603	10
	White	E8332L1_WE_G8	908	1
	Wine Gold	E8332L1_WG_G8	1364	10
16AX 250V 2 Gang 1 Way Switch	Dark Grey	E8332L1_DG_G8	1364	1
	Metal Gold Hairline	E8332L1_GH_G8	1364	10
	Light Wood	E8332L1_LW_G8	1364	10
	Dark Wood	E8332L1_WD_G8	1364	10
16AX 250V 2 Gang 1 Way Switch with LED Indicator	White	E8332L1LED_WE_G8	1364	1
	Wine Gold	E8332L1LED_WG_G8	2047	10
	Dark Grey	E8332L1LED_DG_G8	2047	1
	Metal Gold Hairline	E8332L1LED_GH_G8	2047	10
	Light Wood	E8332L1LED_LW_G8	2317	10
	Dark Wood	E8332L1LED_WD_G8	2047	10
16AX 250V 2 Gang 2 Way Switch	White	E8332L2_WE_G8	1106	1
	Wine Gold	E8332L2_WG_G8	1659	10
	Dark Grey	E8332L2_DG_G8	1659	1
	Metal Gold Hairline	E8332L2_GH_G8	1659	10
	Light Wood	E8332L2_LW_G8	1878	10
	Dark Wood	E8332L2_WD_G8	1659	10

Please contact Customer Care Center for Stockable and Non stockable status of references.

NORMAL STOCK ITEMS

W.E.F. January 17<sup>th</sup>, 2024

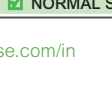
# AvatarOn - It's also a Switch

		Product Description	Color	Product Ref. No.	Unit MRP [₹]	Pack
<b>16A Switches (Base + Cover Plate)</b>						
 <b>E8332L2LED_WE_G8</b>	 <b>E8332L2LED_WD_G8</b>	16AX 250V 2 Gang 2 Way Switch with LED Indicator	White	E8332L2LED_WE_G8	1,659	10
			Wine Gold	E8332L2LED_WG_G8	2,490	10
			Dark Grey	E8332L2LED_DG_G8	2,490	1
			Metal Gold Hairline	E8332L2LED_GH_G8	2,490	10
			Dark Wood	E8332L2LED_WD_G8	2,490	10
 <b>E8333L1LED_WE_G8</b>	 <b>E8333L1LED_WD_G8</b>	16AX 250V 3 gang 1 Way Switch	White	E8333L1_WE_G8	1,491	1
			Wine Gold	E8333L1_WG_G8	2,238	10
			Dark Grey	E8333L1_DG_G8	2,280	1
			Metal Gold Hairline	E8333L1_GH_G8	2,238	10
			Light Wood	E8333L1_LW_G8	2,238	10
 <b>E8333L2_WE_G8</b>	 <b>E8333L2_WD_G8</b>	16AX 250V 3 gang 1 Way Switch with LED Indicator	Dark Wood	E8333L1_WD_G8	2,238	10
			White	E8333L1LED_WE_G8	2,238	10
			Wine Gold	E8333L1LED_WG_G8	3,355	10
			Dark Grey	E8333L1LED_DG_G8	3,355	1
			Metal Gold Hairline	E8333L1LED_GH_G8	3,355	10
 <b>E8333L2LED_WE_G8</b>	 <b>E8333L2LED_WD_G8</b>	16AX 250V 3 gang 2 Way Switch	Light Wood	E8333L1LED_LW_G8	3,798	10
			Dark Wood	E8333L1LED_WD_G8	3,355	10
			White	E8333L2_WE_G8	1,605	1
			Wine Gold	E8333L2_WG_G8	2,409	10
			Dark Grey	E8333L2_DG_G8	2,409	1
 <b>E8333L2LED_WE_G8</b>	 <b>E8333L2LED_WD_G8</b>	16AX 250V 3 gang 2 Way Switch with LED Indicator	Metal Gold Hairline	E8333L2_GH_G8	2,409	10
			Light Wood	E8333L2_LW_G8	2,409	10
			Dark Wood	E8333L2_WD_G8	2,409	10
			White	E8333L2LED_WE_G8	2,409	10
			Wine Gold	E8333L2LED_WG_G8	3,612	10
 <b>E8334L1_WE_G8</b>	 <b>E8334L1_WD_G8</b>	16AX 250V 4 Gang 1 Way Switch	Dark Grey	E8333L2LED_DG_G8	3,612	1
			Metal Gold Hairline	E8333L2LED_GH_G8	3,612	10
			Light Wood	E8333L2LED_LW_G8	3,904	10
			Dark Wood	E8333L2LED_WD_G8	3,612	10
			White	E8334L1_WE_G8	2,145	1
 <b>E8334L1LED_WE_G8</b>	 <b>E8334L1LED_WD_G8</b>	16AX 250V 4 Gang 1 Way Switch with LED Indicator	Wine Gold	E8334L1_WG_G8	3,219	10
			Dark Grey	E8334L1_DG_G8	3,219	1
			Metal Gold Hairline	E8334L1_GH_G8	3,219	10
			Light Wood	E8334L1_LW_G8	3,219	10
			Dark Wood	E8334L1_WD_G8	3,219	10
 <b>E8334L2_WE_G8</b>	 <b>E8334L2_WD_G8</b>	16AX 250V 4 Gang 2 Way Switch	White	E8334L1LED_WE_G8	3,219	10
			Wine Gold	E8334L1LED_WG_G8	4,827	10
			Dark Grey	E8334L1LED_DG_G8	4,827	1
			Metal Gold Hairline	E8334L1LED_GH_G8	4,827	10
			Light Wood	E8334L1LED_LW_G8	5,465	10
 <b>E8334L2LED_WE_G8</b>	 <b>E8334L2LED_WD_G8</b>	16AX 250V 4 Gang 2 Way Switch with LED Indicator	Dark Wood	E8334L1LED_WD_G8	4,827	10
			White	E8334L2_WE_G8	2,468	1
			Wine Gold	E8334L2_WG_G8	3,700	10
			Dark Grey	E8334L2_DG_G8	3,770	1
			Metal Gold Hairline	E8334L2_GH_G8	3,700	10
 <b>E8334L2LED_WE_G8</b>	 <b>E8334L2LED_WD_G8</b>	16AX 250V 4 Gang 2 Way Switch with LED Indicator	Light Wood	E8334L2_LW_G8	3,700	10
			Dark Wood	E8334L2_WD_G8	3,700	10
			White	E8334L2LED_WE_G8	3,700	10
			Wine Gold	E8334L2LED_WG_G8	5,551	10
			Dark Grey	E8334L2LED_DG_G8	5,551	1
			Metal Gold Hairline	E8334L2LED_GH_G8	5,551	10
			Dark Wood	E8334L2LED_WD_G8	5,551	10

Please contact Customer Care Center for Stockable and Non stockable status of references.

NORMAL STOCK ITEMS

W.E.F. January 17<sup>th</sup>, 2024

# AvatarOn - It's also a Switch



E8331M\_WE\_G8



E8331PRL1\_WD\_G8



E8332PRL1\_WE\_G8



E8332PRL1\_WD\_G8



E8331D20N\_WE\_G8



E8331D20N\_WD\_G8



E8331D32N\_WE\_G8



E8332D20N\_WD\_G8



E8332D20N\_WE\_G8



E8331D32N\_WD\_G8



E8331D45N\_WE\_G8



E8331D45N\_WD\_G8

Product Description	Color	Product Ref. No.	Unit MRP ₹	Pack
<b>16A Intermediate Switches</b>				
16AX 250V 1 Gang Intermediate Switch	White	E8331M_WE_G8	1,976	1
	Wine Gold	E8331M_WG_G8	2,964	1
	Dark Grey	E8331M_DG_G8	2,964	1
<b>10A Momentary Switches</b>				
10A 250V 1 Gang Momentary Switch	Dark Wood	E8331PRL1_WD_G8	1037	10
	White	E8332PRL1_WE_G8	870	10
10A 250V 2 Gang Momentary Switch	Wine Gold	E8332PRL1_WG_G8	1303	10
	Dark Grey	E8332PRL1_DG_G8	1303	1
	Metal Gold Hairline	E8332PRL1_GH_G8	1,303	10
	Dark Wood	E8332PRL1_WD_G8	1,303	10
<b>Double Pole Switches</b>				
20A 250V 1 Gang Double Pole Switch with LED Indicator	White	E8331D20N_WE_G8	1,535	10
	Wine Gold	E8331D20N_WG_G8	2,299	10
	Dark Grey	E8331D20N_DG_G8	2,299	1
	Metal Gold Hairline	E8331D20N_GH_G8	2,299	10
	Light Wood	E8331D20N_LW_G8	2,237	10
	Dark Wood	E8331D20N_WD_G8	2,299	10
20A 250V 2 Gang Double Pole Switch with LED Indicator	White	E8332D20N_WE_G8	1,954	10
	Wine Gold	E8332D20N_WG_G8	2,760	10
	Dark Grey	E8332D20N_DG_G8	2,760	1
	Metal Gold Hairline	E8332D20N_GH_G8	2,760	10
	Dark Wood	E8332D20N_WD_G8	2,760	10
32A 250V 1 Gang Double Pole Switch with LED Indicator	White	E8331D32N_WE_G8	2,036	10
	Wine Gold	E8331D32N_WG_G8	3,053	10
	Dark Grey	E8331D32N_DG_G8	3,053	1
	Metal Gold Hairline	E8331D32N_GH_G8	3,053	10
	Light Wood	E8331D32N_LW_G8	3,053	10
45A 250V 1 Gang Double Pole Switch with LED Indicator	Dark Wood	E8331D32N_WD_G8	3,053	10
	White	E8331D45N_WE_G8	2,543	10
	Wine Gold	E8331D45N_WG_G8	3,817	10
	Dark Grey	E8331D45N_DG_G8	3,887	1
	Metal Gold Hairline	E8331D45N_GH_G8	3,887	10
	Dark Wood	E8331D45N_WD_G8	3,643	10

Please contact Customer Care Center for Stockable and Non stockable status of references.

NORMAL STOCK ITEMS

W.E.F. January 17<sup>th</sup>, 2024

# AvatarOn - It's also a Switch



E8331BPL1\_WE\_G8



E8331BPL1\_WD\_G8



E8315\_16\_WE



E8315\_16\_WD



E8331FR350\_WE\_G8



E8331FR350\_WD\_G8



E8331\_WE



E8331\_WD



E8331KH\_WE



E8332\_WE



E8332\_WD



E8333\_WE

Product Description	Color	Product Ref. No.	Unit MRP ₹	Pack	
<b>Bell Push Switch</b>					
10A 250V Door Bell Push Switch	White	E8331BPL1_WE_G8	653	1	
	Wine Gold	E8331BPL1_WG_G8	977	10	
	Dark Grey	E8331BPL1_DG_G8	977	1	
	Metal Gold Hairline	E8331BPL1_GH_G8	977	10	
	Light Wood	E8331BPL1_LW_G8	977	10	
	Dark Wood	E8331BPL1_WD_G8	977	10	
<b>Sockets</b>					
6A 2/3 Pin Switched Socket	White	E8315_6_WE	1,293	8	
	Wine Gold	E8315_6_WG	1,675	8	
	Dark Grey	E8315_6_DG	1,644	1	
	Metal Gold Hairline	E8315_6_GH	1,644	8	
	Light Wood	E8315_6_LW	1,675	8	
	Dark Wood	E8315_6_WD	1,644	8	
6/16A Switched Socket	White	E8315_16_WE	1,623	8	
	Wine Gold	E8315_16_WG	2,064	8	
	Dark Grey	E8315_16_DG	2,064	1	
	Metal Gold Hairline	E8315_16_GH	2,103	8	
	Light Wood	E8315_16_LW	2,103	8	
	Dark Wood	E8315_16_WD	2,064	8	
<b>Fan Regulators</b>					
5 Steps 360 Deg Fan Regulator	White	E8331FR350_WE_G8	3,081	1	
	Wine Gold	E8331FR350_WG_G8	4,061	1	
	Dark Grey	E8331FR350_DG_G8	4,061	1	
	Metal Gold Hairline	E8331FR350_GH_G8	4,061	1	
	Light Wood	E8331FR350_LW_G8	4,137	1	
	Dark Wood	E8331FR350_WD_G8	4,061	1	
<b>Switch &amp; Socket Covers (Additional)</b>					
1 Gang Switch Cover	White	E8331_WE	173	1	
	Wine Gold	E8331_WG	479	1	
	Dark Grey	E8331_DG	457	1	
	Metal Gold Hairline	E8331_GH	479	1	
	Dark Wood	E8331_WD	479	1	
1 Gang Switch Cover with Keyholder	White	E8331KH_WE	380	1	
	2 Gang Switch Cover	White	E8332_WE	261	1
		Wine Gold	E8332_WG	654	1
		Dark Grey	E8332_DG	562	1
		Metal Gold Hairline	E8332_GH	654	1
		Light Wood	E8332_LW	624	1
Dark Wood	E8332_WD	654	1		
3 Gang Switch Cover	White	E8333_WE	404	1	
	Wine Gold	E8333_WG	961	1	
	Dark Grey	E8333_DG	825	1	
	Metal Gold Hairline	E8333_GH	961	1	
	Light Wood	E8333_LW	917	1	

Please contact Customer Care Center for Stockable and Non stockable status of references.

NORMAL STOCK ITEMS

W.E.F. January 17<sup>th</sup>, 2024

# AvatarOn - It's also a Switch



E8334\_WE



E8334\_WD



E8315C\_6\_WE



E8315C\_6\_WD



E8315C\_16\_WE



E8315C\_16\_WD



E8332USB\_WE\_G8



E8332USB\_WD\_G8



E8331\_26\_WE



E8332ACQUSB\_WE



E8331\_36\_WE



E8331\_46\_WE



E8330TX\_WE

Product Description	Color	Product Ref. No.	Unit MRP ₹	Pack
4G Switch Cover	White	E8334_WE	632	1
	Wine Gold	E8334_WG	1179	1
	Dark Grey	E8334_DG	1126	1
	Metal Gold Hairline	E8334_GH	1310	1
	Light Wood	E8334_LW	1252	1
	Dark Wood	E8334_WD	1179	1
6A 2/3 Pin Switched Socket Cover	White	E8315C_6_WE	463	12
	Wine Gold	E8315C_6_WG	786	12
	Dark Grey	E8315C_6_DG	786	1
	Metal Gold Hairline	E8315C_6_GH	786	12
	Light Wood	E8315C_6_LW	874	12
	Dark Wood	E8315C_6_WD	786	12
6/16A Switched Socket Cover	White	E8315C_16_WE	500	12
	Wine Gold	E8315C_16_WG	821	12
	Dark Grey	E8315C_16_DG	821	1
	Metal Gold Hairline	E8315C_16_GH	912	12
	Light Wood	E8315C_16_LW	871	12
	Dark Wood	E8315C_16_WD	912	12
<b>USB Chargers</b>				
2 x 2.1A USB Charger with Mobile Holder (2.1A with 2 outputs used simultaneously)	White	E8332USB_WE_G8	7,726	1
	Wine Gold	E8332USB_WG_G8	11,589	1
	Dark Grey	E8332USB_DG_G8	11,589	1
	Metal Gold Hairline	E8332USB_GH_G8	11,589	1
	Light Wood	E8332USB_LW_G8	12,877	1
	Dark Wood	E8332USB_WD_G8	11,589	1
21W Type A+C, PD+QC3.0 USB Charger	Metal Gold Hairline	E8332ACQUSB_GH	7,065	-
	Light Wood	E8332ACQUSB_LW	7,065	-
	Dark Wood	E8332ACQUSB_WD	7,065	-
	White	E8332ACQUSB_WE	5,711	-
	Wine Gold	E8332ACQUSB_WG	7,065	-
<b>Blasket/Frame (to ensure alignment of switches on 2/3/4 Gang metal box)</b>				
2 Gang Blasket/Frame	White	E8331_26_WE	286	1
	Wine Gold	E8331_26_WG	375	1
	Dark Grey	E8331_26_DG	357	1
3 Gang Blasket/Frame	White	E8331_36_WE	315	1
	Wine Gold	E8331_36_WG	441	1
	Dark Grey	E8331_36_DG	421	1
4 Gang Blasket/ Frame	White	E8331_46_WE	336	1
	Wine Gold	E8331_46_WG	473	1
	Dark Grey	E8331_46_DG	451	1
<b>Blank Plates</b>				
1 Gang Blank Plate	White	E8330X_WE	395	1
	Wine Gold	E8330X_WG	594	1
	Dark Grey	E8330X_DG	594	1
	Metal Gold Hairline	E8330X_GH	622	1
	Dark Wood	E8330X_WD	622	1
2 Gang Blank Plate	White	E8330TX_WE	552	10
	Wine Gold	E8330TX_WG	858	10
	Dark Grey	E8330TX_DG	858	1
	Metal Gold Hairline	E8330TX_GH	858	10
	Dark Wood	E8330TX_WD	953	10

Please contact Customer Care Center for Stockable and Non stockable status of references.

NORMAL STOCK ITEMS

W.E.F January 17<sup>th</sup>, 2024

# AvatarOn - It's also a Switch



E8331BPDMW\_ WE\_G8



E8331BPDMW\_ WD\_G8



E8331KPB\_WE



E8332C\_WE\_G8



E8332C\_WD\_G8



E83T727V\_WE



E83T727V\_WD



E8330FSG\_WD



E8331RJS4\_WE



E8331RJS4\_WD

Product Description	Color	Product Ref. No.	Unit MRP ₹	Pack
<b>Hotel Series</b>				
DND, PCU, PW Indicator with Bell Switch (Do Not Disturb, Please Clean Up, Please Wait)	White	E8331BPDMW_WE_G8	5626	1
	Wine Gold	E8331BPDMW_WG_G8	8438	10
	Dark Grey	E8331BPDMW_DG_G8	8438	1
	Dark Wood	E8331BPDMW_WD_G8	8438	10
16AX 3 Gang Switch with PCU, DND, PW Sym (Do Not Disturb, Please Clean Up, Please Wait)	White	E8333DMWS_WE_G8	5354	1
	Wine Gold	E8333DMWS_WG_G8	7812	10
	Dark Grey	E8333DMWS_DG_G8	8184	1
	Dark Wood	E8333DMWS_WD_G8	8336	10
250V 16A Electronic Keycard Switch	White	E8331EKT_WE	9828	1
	Wine Gold	E8331EKT_WG	14743	1
	Dark Grey	E8331EKT_DG	14742	1
	Metal Gold Hairline	E8331EKT_GH	14742	8
	Dark Wood	E8331EKT_WD	15444	1
Panic Button with Key Reset	White	E8331KPB_WE	1699	1
	Dark Grey	E8331KPB_DG	2145	1
10A 2 Gang Mechanical Curtain Switch	White	E8332C_WE_G8	1166	1
	Wine Gold	E8332C_WG_G8	1749	10
	Dark Grey	E8332C_DG_G8	1749	1
	Metal Gold Hairline	E8332C_GH_G8	1749	10
	Light Wood	E8332C_LW_G8	1855	10
	Dark Wood	E8332C_WD_G8	1749	10
115/240V 20VA Universal Version Shaver	White	E83T727V_WE	5454	1
	Wine Gold	E83T727V_WG	8835	1
	Dark Grey	E83T727V_DG	9257	1
	Metal Gold Hairline	E83T727V_GH	9257	1
Dark Wood	E83T727V_WD	9697	1	
<b>Connection Units</b>				
13A 250V 1 Gang Fused Connection Unit	Dark Wood	E8330FSG_WD	1647	10
13A 250V 1 Gang Fused Connection with DP Switch and Neon	Wine Gold	E8331DFSGN_WG	4797	10
	Dark Wood	E8331DFSGN_WD	4886	10
25A 250V 1 Gang Connection Unit	Metal Gold Hairline	E8331TB_GH	2131	10
<b>Telecom, Network, Connectivity &amp; Media Series</b>				
1 Gang Telephone Socket, Shuttered Wallplate	White	E8331RJS4_WE	858	1
	Wine Gold	E8331RJS4_WG	1430	1
	Dark Grey	E8331RJS4_DG	1430	1
	Metal Gold Hairline	E8331RJS4_GH	1430	1
	Light Wood	E8331RJS4_LW	1589	10
	Dark Wood	E8331RJS4_WD	1430	1

Please contact Customer Care Center for Stockable and Non stockable status of references.

NORMAL STOCK ITEMS

W.E.F. January 17<sup>th</sup>, 2024

# AvatarOn - It's also a Switch



E8332RJS4\_WE



E8331RJS5\_WE



E8332RJS5\_WE



E8331RJS6\_WE



E8332RJS6\_WE



E8331TV\_WE



E8331TVSF\_WE



E8332TDRJS5\_WE



E8332TVRJS5\_WE



E8332HDUSB\_WE



E8332HDRJS5\_WE



E8332HDHD\_WE



E8331VC\_WE



E8331RJS\_WE



E8332RJS\_WE

Product Description	Color	Product Ref. No.	Unit MRP ₹	Pack
2G Tel Socket, Shuttered Wallplate	White	E8332RJS4_WE	2,105	1
	Wine Gold	E8332RJS4_WG	3,160	1
	Dark Grey	E8332RJS4_DG	3,016	1
1 Gang RJ45 Data Cat5E, Shuttered	White	E8331RJS5_WE	1,341	1
	Wine Gold	E8331RJS5_WG	2,339	1
	Dark Grey	E8331RJS5_DG	2,232	1
	Metal Gold Hairline	E8331RJS5_GH	2,232	1
	Light Wood	E8331RJS5_LW	2,480	1
	Dark Wood	E8331RJS5_WD	2,339	1
2 Gang RJ45 Data Cat5E, Shuttered	White	E8332RJS5_WE	2,451	1
	Wine Gold	E8332RJS5_WG	4,088	1
	Dark Grey	E8332RJS5_DG	3,902	1
	Metal Gold Hairline	E8332RJS5_GH	3,902	10
	Dark Wood	E8332RJS5_WD	4,088	1
	White	E8331RJS6_WE	1,602	1
1 Gang RJ45 Data Cat6, Shuttered	Wine Gold	E8331RJS6_WG	2,402	1
	Dark Grey	E8331RJS6_DG	2,402	1
	White	E8332RJS6_WE	3,002	1
2 Gang RJ45 Data Cat6, Shuttered	Wine Gold	E8332RJS6_WG	4,504	1
	Dark Grey	E8332RJS6_DG	4,504	1
	White	E8331TV_WE	676	1
	Wine Gold	E8331TV_WG	1,126	1
	Dark Grey	E8331TV_DG	1,126	1
	Metal Gold Hairline	E8331TV_GH	1,126	10
1 Gang TV Socket, 75Ω, Through-Connect	Light Wood	E8331TV_LD	1,193	10
	Dark Wood	E8331TV_WD	1,126	1
	White	E8331TVSF_WE	747	10
	Wine Gold	E8331TVSF_WG	1,252	0
	Dark Grey	E8331TVSF_DG	1,193	1
1 Gang TV Socket, Slave 5-1000	White	E8332TDRJS5_WE	2,105	1
	Wine Gold	E8332TDRJS5_WG	3,509	1
	Dark Grey	E8332TDRJS5_DG	3,350	1
	Metal Gold Hairline	E8332TDRJS5_GH	3,350	1
	Dark Wood	E8332TDRJS5_WD	3,509	1
1 Gang TV+ RJ45 Data Cat5E, Shuttered	White	E8332TVRJS5_WE	2,610	1
	Wine Gold	E8332TVRJS5_WG	4,356	1
	Dark Grey	E8332TVRJS5_DG	4,157	1
	Metal Gold Hairline	E8332TVRJS5_GH	4,157	1
	Dark Wood	E8332TVRJS5_WD	4,840	1
	White	E8332TVRJS6_WE	2,610	1
1 Gang TV+ RJ45 Data Cat6, Shuttered	Wine Gold	E8332TVRJS6_WG	4,356	1
	Dark Grey	E8332TVRJS6_DG	4,157	1
	White	E8332HDUSB_WE	5,563	1
	Wine Gold	E8332HDUSB_WG	9,271	8
	Dark Grey	E8332HDUSB_DG	8,848	1
	White	E8332HDRJS5_WE	3,762	1
HDMI + USB Socket	Wine Gold	E8332HDRJS5_WG	5,641	1
	Dark Grey	E8332HDRJS5_DG	5,077	1
	White	E8332HDHD_WE	3,051	1
HDMI + RJ45 Data Cat5E, Shuttered	Wine Gold	E8332HDHD_WG	5,085	8
	Dark Grey	E8332HDHD_DG	5,085	1
	White	E8331VC_WE	2,428	1
2 Gang HDMI+HDMI, Keystone on Wallplate	Wine Gold	E8331VC_WG	3,642	10
	Dark Grey	E8331VC_DG	3,642	1
	White	E8331RJS_WE	634	10
Volume Control, 5W, 8Ohm	Wine Gold	E8331RJS_WG	951	10
	Dark Grey	E8331RJS_DG	951	1
	White	E8332RJS_WE	1,191	10
1 Gang S Keystone Wallplate (w/o Mod)	Wine Gold	E8332RJS_WG	1,786	10
	Dark Grey	E8332RJS_DG	1,786	1
	White	E8332RJS_WE	1,191	10
2 Gang S Keystone Wallplate (w/o Mod)	Wine Gold	E8332RJS_WG	1,786	10
	Dark Grey	E8332RJS_DG	1,786	1

Please contact Customer Care Center for Stockable and Non stockable status of references.

NORMAL STOCK ITEMS

W.E.F. January 17<sup>th</sup>, 2024



# Kavacha - Weather Protected Series



CSW110-GY-EX



A3031WBP\_WE

- Pleasing looks with **IP56 protection**
- Large press switch
- Co-moulded sealing with no risk of gasket damage
- Chemical resistant & UV stabilised

Description	Reference	Unit MRP ₹	Pack
<b>Kavacha IP56 Surface Mount Switches</b>			
<b>Switches with Looping Terminal</b>			
10A 1 Gang 2 Way Switch	CSW110-GY-EX	3,897	1
10A 1 Gang 2 Way Bell Press Return Switch	CSW110BPR-GY-EX	4,319	1
<b>Double Pole Switches</b>			
20A 1 Gang Double Pole Switch	CSW220-GY-EX	5855	1
<b>Kavacha Heavy Duty Isolator Switches</b>			
35A Triple Pole	WHT35-GY-EX	8,390	1
63A Triple Pole	WHT63-GY-EX	10,806	1
<b>Kavacha IP56 Surface Mount Combined Switched Socket Outlets</b>			
<b>Combination Switch Socket Outlets</b>			
16A Single Pole Switched Socket Outlet	CSC316RP_GY	4796	1
<b>Kavacha IP56 Surface Mount Socket Outlets</b>			
16A Socket Outlet	CSO316RP-GY-EX	3080	1
<b>Kavacha Full-Time Weatherproof Cover</b>			
Full-Time Weatherproof Single Gang Socket Cover (Transparent) IP55	E223R_TR	1115	1
Weatherproof Bell Press Grey	A3031WBP_GY	1687	1
Weatherproof Bell Press White	A3031WBP_WE	1474	1

Please contact Customer Care Center for Stockable and Non stockable status of references.

NORMAL STOCK ITEMS

W.E.F. January 17<sup>th</sup>, 2024

# Metal Boxes



- **Weld free design** to minimize corrosion and rusting without compromising on strength
- Mounting clip and earth pin designed for **easier installation** and to **avoid loss during transportation**
- Removable side plates and optimized knock outs and for **easier wiring**
- Completely tested & validated as per **IS 14772**

Description	Reference	Unit MRP ₹	Pack
<b>Metal Boxes for Indian Format Ranges (Livia, Opale Clipsal X, Unica Pure &amp; ZENcelo India) <span style="color: green;">NEW</span></b>			
<b>0.8 mm thickness</b>			
Metal Box 1 & 2 modules	ME0102	108	20
Metal Box 3 modules	ME0103	139	20
Metal Box 4 modules	ME0104	161	20
<b>1 mm thickness</b>			
Metal Box 1 & 2 modules	MR1102	119	20
Metal Box 3 modules	MR1103	158	20
Metal Box 4 modules	MR1104	182	20
Metal Box 6 modules	MR1106	247	10
Metal Box 8 modules - Horizontal	MR1108	320	10
Metal Box 8 modules - Square	MR1109	320	10
Metal Box 12 module	MR1112	412	5
Metal Box 18 modules	MR1118	488	5

Description	Reference	Unit MRP ₹	Pack
<b>Metal Boxes for BS Format Ranges (AvatarON,ZENcelo BS, NEO, ULTI) - New &amp; Improved Design <span style="color: green;">NEW</span></b>			
<b>Use Bracket/Frame to ensure alignment of switches on 2/3/4 Gang Metal Box (refer to Avataron section for references)</b>			
<b>1 mm thickness</b>			
2 GANG GI Metal Boxes	MM1102	300	20
3 GANG GI Metal Boxes	MM1103	425	20
4 GANG GI Metal Boxes	MM1104	550	20

- Special Metal Box with Gang Partition to accommodate BS format ranges
- Single Metal Box can accommodate up to 4 units
- Number of Gangs for Metal Box = Number of units that it can accommodate (Eg. 3 GANG Metal Box can accommodate up to 3 BS format Units)

Please contact Customer Care Center for Stockable and Non stockable status of references.

NORMAL STOCK ITEMS

W.E.F. January 17<sup>th</sup>, 2024

# MAKE YOUR HOME SMART WITH OUR WISER - SMART HOMES OFFERING

EASY OPERATION | EASY MAINTENANCE | EASY CONTROL | POCKET FRIENDLY

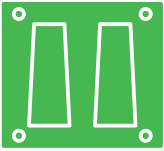

Retrofittable Solution Without any Change in Wiring Infrastructure of the Switches



IoT Technology for & Secure Aspirational Lifestyle Through Automation



Personalized at-Home Experience with the Luxury to Schedule your Appliances for Convenience

## Once there were smart homes, now there are Wiser

Wiser smart home technology revolve around human emotions adding new dimensions to being stylish, aspirational & eco-friendly. Wiser interlinks electrical, multimedia, and telecommunication systems of the house into a single world empowering you to track, control and access your home anytime from anywhere.



Seamless Wifi Interlinking to all Devices of any Brand & Make



Voice- Enabled & Intuitive App Interface for an Hassle Free User Experience



Control & Access Your Home From Anywhere Through Secured Connection



Manage your Energy Consumption to Save on your Bills & Contribute to Sustainability

SE Ref.	Description of reference	Unit MRP [₹]
Wiser 4 Channel Automation Relay	IH14000100	20,000
Wiser Automation Gateway	IH101ZWIFI	38,980
2 Channel Dimmer Controller	IH12000020	20,000
Wiser 1 Channel Analog Dimmer + 1 Channel Direct dimmer Controller	IH12001010	20,000
Wiser Curtain Controller	IH11000200	20,000
Fan Speed Controller	IH1200010F	20,000
Smart Doorbell	IH100WFVDP	35,000
IR Controller	IH101ZW2IR	20,000

Please contact Customer Care Center for Stockable and Non stockable status of references.

NORMAL STOCK ITEMS

W.E.F. January 17<sup>th</sup>, 2024

# Surface and Flush Mount Occupancy Sensors



PIR, Ultrasonic Sensors & High Frequency sensor suitable for both Surface & Flush Mount

Description	Reference	Unit MRP [₹]
Surface Mount Single-Load 360 degrees PIR	CSS54E_WE	3,864
Flush/Surface Mount Single-Load 360 degrees PIR	SAE-UE-MS-CSAWE	4,660
ARGUS Presence Dual-Tech PIR & Ultrasonic Sensor - 1ch	CCT551011	18,575
ARGUS Presence Dual-Tech - 2ch	CCT551012	16,469
ARGUS IR Remote Controller Dual-Tech	CCT556011	18,320
ARGUS Presence High Frequency High Bay Sensor - 2ch	CCT551023	18,023
ARGUS IR Remote Controller HF	CCT556023	16,794
ARGUS Presence Wide Sense - 2ch	CCT551003	15,260
INFRASCAN OUTDOOR 3WIRE 10A	750WPR-GY	19,647
INFRASCAN INDOOR 3WIRE 10A	751R-WE	12,727
INFRASCAN 360DEGREE 3WIRE	753R-WE	11,901



PIR Flush Mount Sensors

Description	Reference	Unit MRP [₹]
ARGUS Standard min 360° False ceiling indoor movement detector	CCT570005	5,453
ARGUS Standard 360° False ceiling indoor movement detector - 2ch	CCT570003	8,007
Flush Mount Dual load 360 degrees standalone sensor	SAE-UE-MS-CDBWE	9,298



## Dimmable Sensors with Light Regulation

0-10V Analogue & Dali Dimmable Sensor

Description	Reference	Unit MRP [₹]
Flush/Surface Mount Dual Load 360° PIR, 0-10V Analogue Dimmable Sensor with remote	SAE-UE-MS-CDDWE	13,298
ARGUS Presence DALI 230V - 2 zones	CCT552006	19,237
ARGUS Presence DALI 230V - Slave	CCT555006	15,477
ARGUS IR Remote Controller DALI	CCT556006	19,238
ARGUS Presence Master with IR, DALI	MTN5510-1519	21,075

Please contact Customer Care Center for Stockable and Non stockable status of references.

NORMAL STOCK ITEMS

W.E.F. January 17<sup>th</sup>, 2024

# Wall Mount Sensors



## BS Standard & Outdoor IP55 Sensor

Description	Reference	Unit MRP [₹]
Neo C-Metro 200 degrees wall mount sensor, grey colour	E3751MS3C_GS	7,255
Zencelo 110 degrees wall mount sensor, white colour	E84751MS3B_WE	6,058
Zencelo 90 degrees wall mount sensor, white colour	E84751MS3A_WE	6,058
Argus 110 Electronic outdoor movement detector, angle of detection 110 degrees, max. range 12 mtrs, IP55 protection	MTN565119	8,029
Argus 220 Electronic movement detector for outdoor ceiling mounting angle of detection 220 degrees, max. range 12 mtrs, IP55 protection	MTN565219	12,388

# Hotel - ELV Dual Motion Sensor

Description	Reference	Unit MRP [₹]
ELV DUAL TECH MOTION SENSOR	SAE_UE_MS_CULV_WE	13,114

Please contact Customer Care Center for Stockable and Non stockable status of references.

NORMAL STOCK ITEMS

W.E.F. January 17<sup>th</sup>, 2024

# Timers & Time Switches

## Analog Time Switches



- 24H, 7D Programmable switch Voltage Rating: 230V AC +10%, -15%
- Memory: Upto 56 Switching Operations
- Back up of program: Operating reserve for 100, 200 Hours
- Overall dimensions: 5 modules
- Minimum time between two switching operations: 15, 30 min
- Accuracy:  $\leq \pm 1$  s/day at +20°C

Description	Module Width 18mm/module	Reference	Unit MRP [₹]
IH 24H 16 A 15 mts interval 1 channel	1	15336	5694
IH 24H 16 A 30 mts interval 1 channel	1	CCT15365	6211
IH 7 day 16 A 1 channel- Max 21 On and 21 Off cycles	3	CCT15367	8891
IH 24H 16 A 30 mts 1 channel without reserve	3	CCT16364	5045

## Digital Time Switches



- 7D, 24H Programmable switch .Voltage Rating: 230V AC +10%, -15%
- Consumption: 1 channel - max. 4VA; 2 channels - max. 7VA
- Memory: Upto 56 Switching Operations
- Back up of program & time by lithium battery: Operating reserve: 6 Years
- Overall dimensions: 5 modules
- Cable length: 100m
- Minimum time between two switching operations: 1 min

Description	Module Width 18mm/module	Reference	Unit MRP [₹]
IHP 1C w (24h/7d) programmable time switch	2.5	CCT15441	12239
IHP+ 1C (24h/7d) SMARTw programmable time switch	2.5	CCT15551	15099
IHP 2C w (24h/7d) programmable time switch	2.5	CCT15443	15788
IHP DCF (24h/7d) SMART programmable time switch	2.5	CCT15858	24853
IHP+ 2C (24h/7d) SMARTw programmable time switch	2.5	CCT15553	17468

## Timers



- Switching capacity 16 A, max
- Delay range from 30 sec to 20 min
- Capacity for lighted pushbutton 150 mA
- Electric distribution busbar compatibility
- Output power capacity CCT15232-2300W
- Output power capacity CCT15223-3600W

Description	Module Width 18mm/module	Reference	Unit MRP [₹]
MINs - electronic timer - 0.5 to 20 min	1	CCT15232	6913
MINs - electronic timer - 0.5 to 20 min with switch Off Warning	1	CCT15233	8878
MINs - electronic timer - 0.5 to 20 min with switch Off Warning and Impulse relay function	1	CCT15234	8345

Please contact Customer Care Center for Stockable and Non stockable status of references.

NORMAL STOCK ITEMS

W.E.F. January 17<sup>th</sup>, 2024

# Timers & Time Switches

## Twilight switch



- Includes wall mounted cell
- Adjustable brightness threshold 2 to 2000 Lux
- 2 LEDs to signal the sensor status and the output status
- Test button: To check the product and load cabling
- Switching capacity: 16Amp
- Screwless Terminals compatible with rigid and flexible wires
- Consumption 6 VA
- Size 45mm

Description	Module Width 18mm/module	Reference	Unit MRP [₹]
IC2000 outdoor (2 - 2000 lux) twilight switch	1	CCT15369	14581
Analogue indoor light sensor cell	-	CCT15262	7195
Wall mounted Analogue outdoor light sensor cell	-	CCT15263	11152
IC100 (2 - 100 lux) twilight switch	1	CCT15482	12266
IC2000 indoor (2 - 2000 lux) twilight switch	1	CCT15285	10931
IC2000p+ (2 - 2000 lux) programmable twilight switch	2.5	CCT15483	25336
IC100kp+ 1C (1 - 99000 lux) SMART programmable twilight switch	2.5	CCT15494	30643
IC100kp+ 2C (1 - 99000 lux) SMART programmable twilight switch	2.5	CCT15495	37724
IC Astro 2C SMART programmable twilight switch	2.5	CCT15245	26484
IC Astro 1C SMART programmable twilight switch	2.5	CCT15225	22285

## Time switch accessories

Description	Module Width 18mm/module	Reference	Unit MRP [₹]
Programming kit for IHP / IC	1	CCT15860	11657

## Thermostat

Description	Module Width 18mm/module	Reference	Unit MRP [₹]
THP1+ 1C (24h/7d) programmable thermostat	2.5	CCT15834	26516

Please contact Customer Care Center for Stockable and Non stockable status of references.

NORMAL STOCK ITEMS

W.E.F. January 17<sup>th</sup>, 2024



## DODIA ELECTRICALS

Our Own Brand



### AUTOMATION BRAND



### SWITCHGEAR BRAND



Address : 9/11, Picket 'X' Road, G.T. Building, Lohar Chawl, Mumbai - 400002.

Email id : sales@dodiaelectricals.com    Whats App / Contact : +91 98338 24773 / 022-22064807

Visit us at : [www.dodiaelectricals.com](http://www.dodiaelectricals.com)